



**NEW  
UPDATED  
PRICING!**

# SEPTEMBER 2022 PRODUCT & PRICE GUIDE

Pricing Supersedes May 2022 Price Guide

- ➔ Sinks
- ➔ Work Tables
- ➔ Dishtables
- ➔ Cabinets
- ➔ Shelving
- ➔ Food Shields
- ➔ Underbar
- ➔ Aluminum Racks





## Now That's SMART FABRICATION™ LOOK AT WHAT WE'RE DOING

### CUSTOM FABRICATION

- Installation of Buyout Equipment
- Buyout Equipment Can Be Pre-Wired
- Load Centers Added
- Food Shields
- Laminate & Custom Vinyl Wraps Designed In-House



Concealed Load Centers for safety & easy access



Custom Electrical Chases for buyout equipment



Wall Flashing in 16, 18 or 20 Ga. Stainless Steel & polished to a satin finish

## CREATE, ACCESSORIZE, UPSELL

**Buildatable & Buildasink** Are Simple And Easy-To-Use Website Tools That Allow You To Click And Choose Accessories For Either A Work Table Or Sink.

**buildatable™.com**  
by ADVANCE TABCO®

**buildasink™.com**  
by ADVANCE TABCO®

For Smart Fabrication™ Quotes

Email [Smartfab@advancetabco.com](mailto:Smartfab@advancetabco.com) or call our Estimating Department at 800-498-6634.

## ONLINE SERVICES AVAILABLE AT advancetabco.com

ACCOUNT ACCESS - CREATE A CUSTOMER LOG-IN  
& FOLLOW THE COMPLETE PROCESS OF YOUR ORDERS

#### KEEP TRACK OF:

- Print Status
- Shipment Tracking Status
- Real-time Order Status
- Latest Sales Flyer
- Excess Inventory Lists

#### ALSO AVAILABLE ONLINE:

- Spec Sheets, CAD & Revit Drawings
- Installation Guides
- Product Support
- Photo & Video Library
- Literature Requests

YOU CAN ALSO FIND US ON AUTOQUOTES, KCL CADALOG  
AND THE FEDA DATA REPOSITORY



CUSTOMER SERVICE IS AVAILABLE TO ASSIST YOU! (8:30AM – 7:00PM EST)

# TABLE OF CONTENTS

## SINKS & SINK ACCESSORIES

Drop-In Sinks..... 3-5  
 Undermount Sinks..... 5  
 Hand Washing Sinks..... 6-11  
 Mobile Hand Sinks ..... 53  
 Hand Sink Mods & Accessories ..... 8, 11-13  
 Mop Sinks & Mop Sink Cabinets ..14-15  
 Multi-Station: Wall Mounted ..... 16-19  
 Multi-Station: Free-Standing ..... 20-23  
 Faucets, Drains & P-Traps 8, 11, 13, 36  
 NSF Regaline Sinks..... 24-28  
 NSF Fabricated Sinks ..... 30-33  
 Sink Mods & Accessories ..... 33-36  
 Specialty Sinks ..... 29  
 Mobile & Silver Soak ..... 34  
 Budget Skullery Sinks ..... 34  
 Budget Skullery Sink Accessories..... 34  
 Floor Troughs, Floor Drains  
 & Water Receptacles .....37  
 Sink Cabinets .....53  
 Integral Sinks.....65

## TABLES & TABLE ACCESSORIES

Standard Work Tables..... 38-49  
 Enclosed Base Tables ..... 50-52  
 Beverage Tables ..... 52  
 Demo Tables..... 55  
 Tables with Sink ..... 55  
 Corner Tables..... 55  
 Mixer Tables ..... 56  
 Wall Mounted Tables.....56  
 Equipment Stands..... 57  
 Filler Tables .....57  
 Poly Top Tables..... 60  
 Wood Top Tables..... 58-59  
 Work Table Modifications  
 & Accessories ..... 61-68  
 Drawers & Accessories ..... 66-67  
 Casters ..... 68  
 Electrical Utility Chase.....76

## FOOD SHIELDS

Food Shields for Multi-Use..... 69  
 Food Shields with S/S Shelf ..... 69-70  
 Food Shields with Glass Top ..... 69, 71  
 Self Serve Food Shields (No Top)..... 72  
 Stationary Food Shields ..... 72  
 Portable Food Shields..... 72  
 Food Shield Accessories ..... 72

LED Lighting..... 73

## STAINLESS STEEL SHELVING

Table Undershelving ..... 68  
 Table Mounted Shelving ..... 74-76, 79  
 Specialty Shelving ..... 75-76, 78  
 Wall Mounted Shelving..... 77-78  
 Tubular Drainage Shelving..... 31, 35  
 Ceiling Mounted Shelving ..... 79  
 Shelving Accessories ..... 79  
 Sorting Shelves For Dishtables ..... 90

## POT RACKS

Shelving with Pot Racks..... 79  
 Table Mounted ..... 80  
 Leg Mounted ..... 82  
 Ceiling Mounted ..... 82  
 Wall Mounted ..... 82

## DISHTABLES

Soil Dishtables..... 84-85, 87  
 Clean Dishtables .....86-87  
 3 Compartment Sink w/ Dishtable .... 88  
 Condensate Hoods ..... 88  
 Vent Riser ..... 88  
 Dishtable Modifications  
 & Accessories ..... 89-90

## COUNTERTOPS

Stainless Steel Countertops.....59  
 Integral Sinks.....65

## CABINETS & WALL FLASHING

Stainless Steel Dish Cabinets ..... 52  
 Sink Cabinets ..... 53  
 Wall Cabinets .....54  
 Storage Cabinets .....54  
 Chemical Cabinets.....54  
 Stainless Steel Wall Flashing .....78

# Underbar Basics™

## UNDERBAR EQUIPMENT

### Underbar Drop-Ins

Drop-In Water Stations..... 92  
 Drop-In Bar Hand Sinks ..... 92-93  
 Drop-In Ice Bins ..... 92-93  
 Drop-In Countertop Drain Pans ..... 93

### Bar Drink Rails

Drink Rails ..... 93

### Free-Standing Bar Sinks

Bar Hand Sinks ..... 94  
 Bar Hand Sinks with Built-In  
 Soap & Towel Dispensers.....94

Bar Hand Sink Modifications  
 & Accessories .....96, 120  
 Bar Sinks ..... 95  
 Bar Sink/Ice Bin Combos ..... 95

### Glass Rinsers

Glass Rinser ..... 93

### Ice Bins

Drop-In Ice Bins ..... 92-93  
 Free-Standing Ice Bins..... 95-96  
 Ice Bin & Drainboard Combo.....95  
 Portable Ice Bin ..... 96  
 Ice Bin with Bottle Storage ..... 96  
 Beer Boxes ..... 99  
 Ice Bin Mods & Accessories ..... 92, 118

### Bar Drainboards

Free Standing Bar Drainboards ..... 97  
 Recessed Bar Drainboards..... 97  
 Frozen Drink Machine Stands..... 97  
 Drainboard Cabinets..... 100

### Blender Stations

Blender Station with Dump Sinks..... 98  
 Blender Station Mods  
 & Accessories ..... 98, 118, 120

### Uni-Serv Speed Bars

Complete Speed Bar Unit ..... 98

### Bar Storage Units

Liquor Bottle Displays ..... 99  
 Glass Rack Storage Cabinets..... 100  
 Drainboard Cabinets..... 100  
 With Dump Sink & Waste Chute ..... 100  
 Storage Unit Accessories  
 & Modifications .....100, 118, 120

### Speed Rails

Stainless Steel Speed Rails ..... 101  
 Black Plastic Speed Rails ..... 101  
 Heavy Duty Speed Rails ..... 101

### Underbar Mods & Accessories

Underbar Mods & Accessories 118-120  
 Underbar Faucets .....122



## UNDERBAR EQUIPMENT

ON NEXT PAGE >>>

Continued on Page 2



**WARNING:** Equipment contained in this Price Guide may expose you to chemicals, including chromium & lead, that are known to the State of California to cause cancer or birth defects or other reproductive harm. For more Info., visit [www.p65warnings.ca.gov](http://www.p65warnings.ca.gov).



= PRODUCTS THROUGHOUT THE PRICE GUIDE WITH THIS ICON ARE SHIPPED VIA UPS

# TABLE OF CONTENTS



## UNDERBAR EQUIPMENT

### Prestige Modular Bar Die Systems

Exclusive Bar Die System ..... 102-103

### Prestige Free-Standing Bar Sinks

Bar Hand Sinks ..... 104-105

Bar Hand Sinks with Built-In

Soap & Towel Dispensers..... 104

Bar Hand Sinks with Cabinet Base ... 105

Bar Sink Mods

& Accessories .....106, 118, 120

Bar Sinks ..... 107

### Prestige Ice Bins

Free-Standing Ice Bins..... 108

Ice Bin & Bottle Storage..... 108

Beer Box..... 113

Pass-Thru Ice Bins ..... 113

### Prestige Uni-Serv Speed Bars

Complete Speed Bar Unit ..... 113

### Prestige Pass-Thru Work Stations

Standard Pass-Thru Workstations .... 114

Overshelves For Pass-Thru

Workstations..... 114

### Prestige Bar Drainboards

Drainboard Fillers..... 109

Free Standing Bar Drainboards ..... 110

Recessed Bar Drainboards..... 110

Frozen Drink Machine Stands..... 110

Drainboard With Blender Station..... 115

Drainboard Glass Rack Storage ..... 116

### Prestige Blender Stations

With Deep Drawn Sink ..... 115

With Drainboard .....115

Blender Shelf ..... 117

### Prestige Bar Storage Units

Point of Service Cabinet.....112

Drainboard Storage Cabinets .....112

Glass Rack Storage Cabinets..... 116

Liquor Bottle Displays ..... 116

### Trash Receptacles

Trash Receptacle Cabinets..... 112

### Prestige Speed Rails

Stainless Steel Speed Rails ..... 117

Hang-On Style Speed Rails ..... 117

### Under Bar Mods & Accessories

Soda Gun Holder for Prestige®

Pass-Thru Workstations ..... 118

Prestige Mods & Accessories... 118-120

### PORTABLE BARS

#### Heavy Duty Bars

Heavy Duty Bars ..... 121

With Stainless Steel Doors ..... 121

#### Standard Bars

Black Mica W/Stainless Steel Top .... 122

Black Mica W/All Stainless Steel

Work Area ..... 122

#### Portable Bar Options

Portable Bar with Laminates .....121

Portable Bar Mods & Accessories .....122

### HOT/COLD FOOD UNITS

#### Hot Well Drop-In Units

Standard Drop-In Units ..... 124

Slimline Drop-In Units..... 124

Hot Well Drop-In Accessories ..... 124

#### Hot Well Food Tables

Electric Powered Hot Food Tables ... 125

Electric Powered Sealed Well Tables 126

Gas Powered Hot Food Tables ..... 127

Gas Powered Wetbath Tables ..... 128

#### Solid Top Food Tables

Solid Top Food Tables..... 129

#### Cold Well Drop-In Units

Ice-Cooled Drop-In Cold Pan Units .. 130

Refrigerated Drop-In Cold Pan Units...130

#### Cold Food Tables

Standard Ice-Cooled Tables ..... 131

Mechanically Assisted

Cold Pans Tables ..... 132

#### Heavy Duty Food Tables

Electric Sealed Hot Well Tables ..... 133

Refrigerated Cold Well Tables ..... 133

Ice-Cooled Tables ..... 133

### Everyday Buffet Tables

Electric Hot Well Buffets ..... 134

Electric Sealed Hot Well Buffets..... 134

Ice Cooled Buffets..... 135

Solid Top Buffets ..... 135

Mechanically Assisted

Cold Pan Buffets ..... 136

Cash Register Stands ..... 136

Silverware Stand..... 136

Everyday Buffet Accessories ..... 137

### Food Table Shelving & Parts

Hot/Cold Food Table Shelving..... 137

Food Shields for Hot/cold Tables .....138

Hot Food Table Parts

& Accessories ..... 137-140

LED Lighting for Hot/Cold Tables .... 139

### ALUMINUM RACKS & PANS

Aluminum Racks ..... 141-145

Aluminum Bun Pans..... 146

Aluminum Rack Accessories ..... 146

### Mobile Racks & Carts

Aluminum Pan Trucks ..... 147

Aluminum Dunnage Racks ..... 147

Utility Carts ..... 147

### WIRE SHELVING

Chrome & Green Epoxy

Wire Shelving..... 148-149

Wire Utility Carts ..... 149

Wall Mounted Shelving System.....150

Wire Shelving Replacement Parts

& Accessories ..... 150

### WARRANTY

Warranty, Terms & Conditions ..... 151



= PRODUCTS THROUGHOUT THE  
PRICE GUIDE WITH THIS ICON  
ARE SHIPPED VIA UPS



# DROP-INS

## Drop-In Sinks

Holes Punched 4" O.C. For Faucet Hole Revision Order K-472 \$176 Cut-Out Size Requires 1-1/4" Radius Corners. Maximum Counter Thickness Is 2".

INCLUDES K-52 LEAD FREE COMPLIANT FAUCET & BASKET DRAIN. (DI-1-25 INCLUDES 2" DRAIN WITH STRAINER PLATE)  
(To delete faucet, order K-52OMIT and deduct \$24)

All Sinks on this Page Ship Via UPS

### ONE COMPARTMENT Countertop Mounted, Self Rim Design

For Residential Finish & Packaging,  
Add K-350 \$503



#### DI-1-5 \$825

10" x 14" x 5" Bowl  
Overall: 13" x 19"  
Cut-out: 12 1/4" x 18 1/4"  
12 lbs. 2 cu. ft. 20 gauge



#### DI-1-10 \$935

10" x 14" x 10" Bowl  
Overall: 13" x 19"  
Cut-out: 12 1/4" x 18 1/4"  
14 lbs. 2 cu. ft. 20 gauge



#### DI-1-25 \$919

**Space Saver**  
9" x 9" x 5" Bowl  
Overall: 12" x 14"  
Cut-out: 11 1/4" x 13 1/4"  
8 lbs. 2 cu. ft. 20 gauge



#### DI-1-1515 \$1056

12 1/4" x 10 1/4" x 6" Bowl  
Overall: 15" x 15"  
Cut-out: 14 1/4" x 14 1/4"  
Requires 1 1/2" Radius Corners  
11 lbs. 2 cu. ft. 20 gauge



#### DI-1-35 \$963

14" x 10" x 5" Bowl  
Overall: 17" x 15"  
Cut-out: 16 1/4" x 14 1/4"  
10 lbs. 2 cu. ft. 20 gauge



#### DI-1-168 \$1200

16" x 14" x 8" Bowl  
Overall: 19" x 19"  
Cut-out: 18 1/4" x 18 1/4"  
20 lbs. 3 cu. ft. 18 gauge



#### DI-1-208 \$1284

20" x 16" x 8" Bowl  
Overall: 23" x 21"  
Cut-out: 22 1/4" x 20 1/4"  
20 lbs. 3 cu. ft. 18 gauge



#### DI-1-2012 \$1474

20" x 16" x 12" Bowl  
Overall: 23" x 21"  
Cut-out: 22 1/4" x 20 1/4"  
20 lbs. 6 cu. ft. 18 gauge



#### DI-1-5SP \$2159

**6" Tapered Side Splash**

Splash on Rear and Both Sides  
10" x 14" x 5" Bowl  
Overall: 13" x 19"  
Cut-out: 12 1/4" x 18 1/4"  
16 lbs. 2 cu. ft. 20 gauge



#### DI-1-10SP \$2319

**6" Tapered Side Splash**

Splash on Rear and Both Sides  
10" x 14" x 10" Bowl  
Overall: 13" x 19"  
Cut-out: 12 1/4" x 18 1/4"  
18 lbs. 2 cu. ft. 20 gauge



#### DI-1-30 \$1408

**2" Tapered Side Splash**

14" x 10" x 5" Bowl  
Overall: 16" x 15"  
Cut-out: 15" x 14 1/4"  
12 lbs. 2 cu. ft. 20 gauge

Splash on  
All 3 Sides

Optional 12" Tapered Side Splash Upgrade K-12SS \$638

**IMPROVED!**  
Stronger Acuator



Includes  
water filler  
faucet,  
grating  
& drain

#### DI-1-9 \$1466

**Filler Station**  
9" x 9" x 3" Bowl  
Overall: 12" x 14"  
Cut-out: 11 1/4" x 13 1/4"  
15 lbs. 2 cu. ft. 20 gauge

### Removable 8" Splash Wrap for Existing Drop-In Sinks \$1133 ea.

Model #	Fits Drop-In Sink:
K-614A	DI-1-25 & DI-1-9
K-614B	DI-1-5 & DI-1-10
K-614C	DI-1-1515
K-614D	DI-1-30 & DI-1-35
K-614E	DI-1-168
K-614F	DI-1-208 & DI-1-2012
K-614G	DI-1-2812



Protect Your  
Surrounding Area!

### The Largest One Compartment Drop-In Sink in the Industry!

#### DI-1-2812 \$2512

28" x 20" x 12" Bowl  
Overall: 31" x 25"  
Cut-out: 30 1/4" x 24 1/4"  
47 lbs. 7 cu. ft. 16 gauge



Supplied with K-53 Lead Free Compliant Faucet & Basket Drain  
(To delete faucet, Order K-53OMIT and deduct \$24)

**WARNING:** Equipment that includes a faucet may expose you to chemicals, including lead, that are known to the State of California to cause cancer or birth defects or other reproductive harm. For more info, visit [www.p65warnings.ca.gov](http://www.p65warnings.ca.gov).

# DROP-INS

## Drop-In Sinks



= Ship Via UPS

Holes Punched 4" O.C. For Faucet Hole Revision Order K-472 \$176. Cut-Out Size Requires 1-1/4" Radius Corners.  
Maximum Counter Thickness Is 2".

INCLUDES K-50 LEAD FREE COMPLIANT FAUCET & BASKET DRAIN (To delete faucet, order K-500MIT and deduct \$24)

### TWO COMPARTMENT

Countertop Mounted, Self Rim Design



### THREE COMPARTMENT

Countertop Mounted, Self Rim Design

#### DI-3-10 \$2796

10" x 14" x 10" Bowl  
Overall: 38" x 19"  
Cut-out: 37 1/4" x 18 1/4"  
34 lbs. 5 cu. ft. 20 gauge



#### DI-2-10 \$1850

10" x 14" x 10" Bowl  
Overall: 25 1/2" x 19"  
Cut-out: 24 3/4" x 18 1/4"  
26 lbs. 4 cu. ft. 20 gauge

#### DI-2-2012 \$2910

20" x 16" x 12" Bowl  
Overall: 45 1/2" x 21"  
Cut-out: 44 3/4" x 20 1/4"  
42 lbs. 9 cu. ft. 18 gauge

#### DI-3-1410 \$3747

16" x 14" x 10" Bowl  
Overall: 50" x 21"  
Cut-out: 49 1/4" x 20 1/4"  
38 lbs. 8 cu. ft. 18 gauge



#### DI-2-1410 \$2781

14" x 16" x 10" Bowl  
Overall: 33 1/2" x 21"  
Cut-out: 32 3/4" x 20 1/4"  
35 lbs. 6 cu. ft. 18 gauge

#### DI-2-208 \$2275

20" x 16" x 8" Bowl  
Overall: 45 1/2" x 21"  
Cut-out: 44 3/4" x 20 1/4"  
40 lbs. 6 cu. ft. 18 gauge

#### DI-3-1612 \$4221

16" x 20" x 12" Bowl  
Overall: 56" x 25"  
Cut-out: 55 1/4" x 24 1/4"  
60 lbs. 12 cu. ft. 18 gauge



Includes a K-53 Faucet. To delete, order K-530MIT & deduct \$24

**DID YOU KNOW?** 2 & 3 Compartment Drop-In Sinks are N.S.F. Approved when only used in Mobile Food Carts and Kiosks.

# FAUCETS & SPOUTS

## Deck Mounted Faucets, Spouts & Mounting Clips

#### Drinking Bubbler

K-47 \$1057



#### 8" Swing Spout

K-50 \$377



#### Water Filler Faucet

K-54

8-1/4" High \$744

K-54A

12" High \$845



#### Swing Spout Faucet & Spray

K-58 \$444

8" O.C.



#### Mounting Clips Extended



For Countertops Over 7/8" & up to 2" Thick  
Quantity supplied (4-Pack), varies based on drop-in sink ordered.

K-28 \$21

#### Deck Mounted Single Handle Faucet

K-48 \$740



#### 3-1/2" Gooseneck

K-52 \$331

4" O.C.



#### Large 8-1/2" Spout Gooseneck

K-55

\$626

4" O.C.



#### EXTRA HEAVY DUTY Gooseneck

K-62 \$644

4" O.C.



Upgrade

#### 12" Swing Spout

K-53 \$626

4" O.C.



#### Deck Mounted Faucet with Wrist Handles

K-56

\$473

4" O.C.



#### 6" Deck Mounted Extended Faucet with Wrist Handles

K-208

\$653

4" O.C.



#### FAUCET REPAIR KITS\*

For K-50, K-52, K-53, K-55, K-56

K-00B \$168

(2 Cartridges & 2 Handles Per Set)

\*Can Only Be Used On Faucets Purchased After January 2016. For Older Faucets, Consult Customer Service.

For K-54 & K-54A Filler Faucet

K-02 \$140

Purchased from 2016 to 2019



K-02A \$140

Purchased before 2016 or after 2019



**WARNING:** Equipment that includes a faucet may expose you to chemicals, including lead, that are known to the State of California to cause cancer or birth defects or other reproductive harm. For more info, visit [www.p65warnings.ca.gov](http://www.p65warnings.ca.gov).

# SMART SERIES™

## Countertop Mounted, Self Rim Design

Maximum Counter Thickness is 2". 8" O.C. Faucet Holes: Unit punched with 1-1/4" Diameter for the hot & cold water supply lines. Center hole punched with 1" Diameter.  
For Faucet Hole Revision Order K-472 \$176.

- 18 Gauge, Seamless Deep Drawn Self Rimming Stainless Steel Bowls.
- Bowls Are Sound Deadened.
- Flat Deck Allowing More Faucet Options.
- Units Feature Advance Tabco's Smart Finish.
- Faucet Optional

### SINGLE BOWL DROP-IN SINKS

Model #	Price	O.A. Size L x W	Bowl Size L x W	Cut-Out Size (1 1/4" Radius Corners)	Wt.	Cu. Ft.
SS-1-1319-10	<b>\$1527</b>	13" x 19"	14" x 10" x 10"	12 1/4" x 18 1/4"	14 lbs.	2
SS-1-1715-7	<b>1527</b>	17" x 15"	14" x 10" x 7 1/2"	16 1/4" x 14 1/4"	12 lbs.	2
SS-1-1715-10	<b>1702</b>	17" x 15"	14" x 10" x 10"	16 1/4" x 14 1/4"	14 lbs.	3
SS-1-1919-7	<b>1814</b>	19" x 19"	16" x 14" x 7 1/2"	18 1/4" x 18 1/4"	16 lbs.	3
SS-1-1919-10	<b>1915</b>	19" x 19"	16" x 14" x 10"	18 1/4" x 18 1/4"	18 lbs.	4
SS-1-1919-12	<b>1993</b>	19" x 19"	16" x 14" x 12"	18 1/4" x 18 1/4"	20 lbs.	4
SS-1-2321-10	<b>2155</b>	23" x 21"	20" x 16" x 10"	22 1/4" x 20 1/4"	22 lbs.	6
SS-1-2321-12	<b>2291</b>	23" x 21"	20" x 16" x 12"	22 1/4" x 20 1/4"	24 lbs.	6

### DOUBLE BOWL DROP-IN SINKS

SS-2-3321-10	<b>2465</b>	33 1/2" x 21"	14" x 16" x 10"	32 3/4" x 20 1/4"	35 lbs.	6
SS-2-3321-12	<b>2688</b>	33 1/2" x 21"	14" x 16" x 12"	32 3/4" x 20 1/4"	37 lbs.	9
SS-2-4521-10*	<b>2893</b>	45 1/2" x 21"	20" x 16" x 10"	44 3/4" x 20 1/4"	39 lbs.	9
SS-2-4521-12*	<b>3161</b>	45 1/2" x 21"	20" x 16" x 12"	44 3/4" x 20 1/4"	40 lbs.	10

SS-1-1715-7  
Shown



SS-1-2321-10  
Shown



SS-2-3321-10  
Shown



For Faucets,  
See Page 4.



## LAUNDRY ROOM SINK



- 16 Gauge
- Three 4" O.C. Holes\*
- Bowl Size: 24" x 18" x 14"\*\*\*
- Overall Size: 27" x 23"
- Cutout: 26 1/4" x 20 1/4"

**LS-2418-14RE \$3908**

\*\* Requires 30" Wide Countertop (Front to Back)

\*Shown with Faucet Hole Revision K-472 \$176

## STAINLESS STEEL SINK GRIDS

- Perforated Grid
- Raised Bottom
- Side Notches for Easy Removal

**K-610 \$1066**

(Specify Bowl Size When Ordering)



## Undermounts

Undermount Bowls are suitable to be welded by others into stainless steel products. Multiple compartment assemblies available. Call for pricing.

- 3 1/2" Drain Opening
- 1-1/4" Outside Flange



2028A-12 Shown



CO-1014A-10RE Shown

Model #	Price	# Of Compartments	Gauge	Bowl Size LxWxD	Radius	O.D. Trim Size
1014B-05	<b>\$553</b>	1	20	10" x 14" x 5"	2"	12 1/2" x 16 1/2"
1014A-10	<b>672</b>	1	20	10" x 14" x 10"	2"	12 1/2" x 16 1/2"
1014A-10A	<b>867</b>	1	18	10" x 14" x 10"	2"	12 1/2" x 16 1/2"
CO-1014A-10RE*	<b>1222</b>	1	18	10" x 14" x 10"	2"	12 1/2" x 16 1/2"
1014-210-BAD	<b>1494</b>	2	18	10" x 14" x 10"	2"	25" x 16 1/2"
1014-310-BAD	<b>2345</b>	3	18	10" x 14" x 10"	2"	37 1/2" x 16 1/2"
CO-1416A-10RE*	<b>1296</b>	1	18	14" x 16" x 10"	3"	12 1/2" x 18 1/2"
1416-212-BAD	<b>2485</b>	2	18	14" x 16" x 12"	3"	33" x 18 1/2"
1416-312-BAD	<b>3816</b>	3	18	14" x 16" x 12"	3"	49 1/2" x 18 1/2"
1620A-10	<b>1076</b>	1	18	16" x 20" x 10"	3"	18 1/2" x 22 1/2"
1620A-12	<b>1279</b>	1	18	16" x 20" x 12"	3"	18 1/2" x 22 1/2"
1620A-14A	<b>1584</b>	1	14	16" x 20" x 14"	3"	18 1/2" x 22 1/2"
1620-212-BAD	<b>2739</b>	2	16	16" x 20" x 12"	3"	37" x 22 1/2"
1620-312-BAD	<b>4198</b>	3	16	16" x 20" x 12"	3"	55 1/2" x 22 1/2"
1824A-12	<b>2243</b>	1	18	18" x 24" x 12"	3"	20 1/2" x 26 1/2"
1824A-14A	<b>2515</b>	1	14	18" x 24" x 14"	3"	20 1/2" x 26 1/2"
2020A-12	<b>1432</b>	1	18	20" x 20" x 12"	3"	22 1/2" x 22 1/2"
2020A-14	<b>1546</b>	1	18	20" x 20" x 14"	3"	22 1/2" x 22 1/2"
2028A-12	<b>2373</b>	1	16	20" x 28" x 12"	3"	22 1/2" x 30 1/2"
2028A-14A	<b>2665</b>	1	14	20" x 28" x 14"	3"	22 1/2" x 30 1/2"
2424A-14A	<b>2792</b>	1	14	24" x 24" x 14"	3"	26 1/2" x 26 1/2"

\* Includes Residential Finish & Packaging. Add K-350 \$503 for Other Models to Add Residential Finish & Packaging.

**WARNING:** Equipment that includes a faucet may expose you to chemicals, including lead, that are known to the State of California to cause cancer or birth defects or other reproductive harm. For more info., visit [www.p65warnings.ca.gov](http://www.p65warnings.ca.gov).

# HAND SINKS

## Hand Washing Sinks



To delete faucet, order K-590MIT and deduct \$24

= All Sinks On This Page Ship Via UPS All Sinks on this Page

### STANDARD UNITS

Bowl Size: 10" x 14" x 5" • Overall Size: 15 1/4" x 17 1/4" Unless Otherwise Specified  
Includes K-59 Splash Mount Faucet, 3-1/2" Basket Drain & Wall Bracket (Unless Otherwise Specified)



**7-PS-60 \$839**  
Standard Unit  
13 lbs. 2 cu. ft. 20 gauge



**7-PS-68 \$998**  
K-316 Splash Mount  
Wrist Handle Faucet  
13 lbs. 2 cu. ft. 20 gauge



**7-PS-67 \$928**  
Lever Operated  
15 lbs. 2 cu. ft. 20 gauge



**7-PS-50 \$1097**  
Lever Operated  
with Overflow & P-Trap  
15 lbs. 2 cu. ft. 20 gauge



**7-PS-54 \$1014**  
1 1/2" P-Trap  
15 lbs. 2 cu. ft. 20 gauge



**7-PS-20 \$875**  
K-22 Deck Mount Faucet  
15 lbs. 3 cu. ft. 20 gauge  
**Overall Size:**  
17-1/4" x 17-1/4"

### SIDE SPLASH UNITS

Bowl Size: 10" x 14" x 5" • Overall Size: 15 1/4" x 17 1/4" Unless Otherwise Specified  
Includes 7-3/4" High Welded Side Splashes, K-59 Splash Mount Faucet, 3-1/2" Basket Drain & Wall Bracket (Unless Otherwise Specified)



**7-PS-66R or L \$1324**  
Right or Left Side Splash  
13 lbs. 2 cu. ft. 20 gauge

Unit Shown:  
7-PS-66R



**7-PS-66 \$1428**  
Standard Unit  
19 lbs. 2 cu. ft. 20 gauge



**7-PS-66W \$1536**  
K-316 Splash Mt. Faucet  
w/ Wrist Handles  
19 lbs. 2 cu. ft. 20 gauge



**7-PS-40 \$1744**  
Lever Operated  
With Overflow & P-Trap  
20 lbs. 2 cu. ft. 20 gauge



**7-PS-76 \$2228**  
Full Length Removable  
Utility Tray  
K-59 Splash Mt. Faucet  
Lever Operated  
With Overflow & P-Trap  
12" High Welded Side Splashes  
24 lbs. 2 cu. ft. 20 gauge



**7-PS-87 \$2881**  
Towel & Soap Dispenser  
K-316 Splash Mt. Faucet  
with Wrist Handles  
Lever Operated  
With Overflow & P-Trap  
34 lbs. 10 cu. ft. 20 gauge

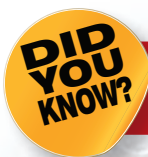

You Can Add Side Splashes To Any Hand Sink  
See Page 12



**7-PS-73 \$2798**  
7 3/4" High Side Splashes  
Towel Dispenser  
Deck Mt. Soap Dispenser  
K-123 Splash Mt. Faucet  
31 lbs. 5 cu. ft. 20 gauge

**WARNING:** Equipment that includes a faucet may expose you to chemicals, including lead, that are known to the State of California to cause cancer or birth defects or other reproductive harm. For more info., visit [www.p65warnings.ca.gov](http://www.p65warnings.ca.gov).





All Sinks on this Page



All Sinks On This Page Ship Via UPS

# HAND SINKS

## Hand Washing Sinks

### SOAP & TOWEL DISPENSER UNITS

Bowl Size: 10" x 14" x 5" • Overall Size: 15 1/4" x 17 1/4"

Includes C-Fold Style Towel Dispenser, Liquid Soap Dispenser, K-59 Splash Mount Faucet, 3-1/2" Basket Drain & Wall Bracket (Unless Otherwise Specified)  
To delete faucet, order K-59OMIT and deduct \$24



**7-PS-69 \$3099**  
Splash Mounted Faucet  
With Wrist Handles  
Lever Operated With  
Overflow & P-Trap  
Side Support Brackets  
K-69 (T&S) Faucet  
35 lbs. 6 cu. ft. 20 gauge



**7-PS-79 \$2094**  
Standard Unit  
32 lbs. 10 cu. ft. 20 gauge



**7-PS-80 \$2296**  
Lever Operated  
With Overflow & P-Trap  
32 lbs. 10 cu. ft. 20 gauge

ALL-IN-ONE  
UNIT



**7-PS-85 \$2554**  
P-Trap & Skirt  
35 lbs. 6 cu. ft. 20 gauge



**7-PS-131 \$5192**  
All-In-One  
Touchless Soap Dispenser  
Towel Dispenser  
7-3/4" High Side Splashes  
K-175 Faucet  
40 lbs. 10 cu. ft. 20 gauge

#### UPGRADE TO TOUCHLESS SOAP DISPENSER

Battery Powered (4 "AA" Batteries Required, Not Included)  
Add **7-PS-104 \$441** Plus **7-PS-12OMIT** (Deduct -\$49)  
Excludes 7-PS-131



### UNDERMOUNT TOWEL DISPENSER UNITS

#### 7-PS-41 \$6200

A.D.A. Compliant Tapered Bowl Design  
Hands Free Operated Faucet  
Undermount Towel Dispenser  
1-1/2" Drain w/ Flat-Top Strainer Plate  
16 Gauge Skirt with Enclosed Bottom  
For Storage w/ Removable Access Panel  
43 lbs. 8 cu. ft. 18 gauge



Available with K-123 "D" Spout  
Splash Mt. Wrist Handle Faucet  
**7-PS-46 \$4114**

For More A.D.A. Compliant  
Sinks, please see page 10.



#### 7-PS-65 \$2440

Undermount Towel Dispenser  
with Skirt  
Deck Mounted Soap Dispenser  
K-22 Deck Mounted Faucet  
35 lbs. 10 cu. ft. 20 gauge

### 12" WIDE SPACE SAVER UNITS

Bowl Size: 9" x 9" x 5" • Overall Size: 16" x 12"  
Includes 2" Drain With Flat Top Strainer & Wall Bracket



**7-PS-22 \$1081**  
K-22 Deck Mounted Faucet  
12 lbs. 2 cu. ft. 20 gauge



**7-PS-23 \$1130**  
K-123 Splash Mounted Faucet  
12 lbs. 2 cu. ft. 20 gauge



**7-PS-53 \$3218**  
K-175 Splash Mt. Electronic Faucet  
12 lbs. 2 cu. ft. 20 gauge



**7-PS-56 \$1729**  
K-123 Splash Mounted Faucet  
8" High Side Splashes  
14 lbs. 2 cu. ft. 20 gauge

### SOAP/TOWEL UNITS



**7-PS-88 \$2269**  
Undermount Towel Dispenser  
Deck Mt. Soap Dispenser  
K-22 Deck Mt. Faucet  
23 lbs. 10 cu. ft. 20 gauge



7-PS-83

#### 7-PS-83 \$2122

Towel Dispenser  
Deck Mt. Soap Dispenser  
K-22 Deck Mt. Faucet  
27 lbs. 5 cu. ft. 20 gauge

#### 7-PS-89 \$4039

7 3/4" High Side Splashes  
Towel Dispenser  
Deck Mt. Soap Dispenser  
K-175 Splash Mt. Electronic Faucet  
40 lbs. 5 cu. ft. 20 gauge



7-PS-89



7-PS-84

#### 7-PS-84 \$2211

Towel Dispenser  
Deck Mt. Soap Dispenser  
K-123 Splash Mt. Faucet  
27 lbs. 5 cu. ft. 20 gauge

#### 7-PS-73 \$2798

7 3/4" High Side Splashes  
Towel Dispenser  
Deck Mt. Soap Dispenser  
K-123 Splash Mt. Faucet  
31 lbs. 5 cu. ft. 20 gauge



7-PS-73

# HANDS-FREE Hand Washing Sinks



All Sinks on this Page



All Sinks On This Page Ship Via UPS

## HANDS-FREE ELECTRONIC OPERATED FAUCETS

Bowl Size: 10" x 14" x 5" • Overall Size: 15 1/4" x 17 1/4" Includes K-175 AC/DC Powered Electronic Operated Faucet

**7-PS-131**  
**\$5192**

**All-In-One**  
Touchless Soap Dispenser  
Towel Dispenser  
7-3/4" High Side Splashes  
K-175 Faucet  
40 lbs. 10 cu. ft. 20 gauge



7-PS-81 Shown

**7-PS-51 \$3182**

Equal to 7-PS-50 w/ K-175 Faucet  
21 lbs. 2 cu. ft. 20 gauge

**7-PS-81 \$4381**

Equal to 7-PS-80 w/ K-175 Faucet  
32 lbs. 10 cu. ft. 20 gauge

**7-PS-52 \$4175**

Equal to 7-PS-81. Excludes Lever Drain,  
P-Trap and Overflow  
31 lbs. 10 cu. ft. 20 gauge

Upgrade To Touchless Soap Dispenser,  
Add 7-PS-104 **\$441**  
Plus 7-PS-120MIT (Deduct **-\$49**)



**7-PS-61 \$2927**

Equal to 7-PS-60 w/ K-175 Faucet  
19 lbs. 2 cu. ft. 20 gauge



**7-PS-91 \$4228**

Equal to 7-PS-90 w/ K-175 Faucet  
41 lbs. 10 cu. ft. 20 gauge

## KNEE VALVE OPERATED FAUCETS

Includes Single Knee Valve (With Built-In Mixing Valve), K-121 Splash Mt. Gooseneck Spout, Skirt, 3-1/2" Basket Drain (Otherwise Noted) & Wall Bracket



**7-PS-62 \$2137**

**Standard Unit**  
Bowl Size: 10" x 14" x 5"  
Overall : 15-1/4" x 17-1/4"  
25 lbs. 2 cu. ft. 20 gauge



**7-PS-30 \$2301**

**Large Bowl Size**  
Bowl Size: 16" (F/B) x 14" x 6"  
Overall : 21-1/4" (F/B) x 17-1/4"  
33 lbs. 8 cu. ft. 18 gauge



**7-PS-59 \$2763**

**Side Splash Unit**  
Bowl Size: 10" x 14" x 5"  
Overall : 15-1/4" x 17-1/4"  
7-3/4" Side Splashes  
31 lbs. 2 cu. ft. 20 gauge



**7-PS-63 \$2137**

**Spacesaver**  
1-1/2" Basket Drain  
Bowl Size: 9" x 9" x 5"  
Overall : 12-1/4" x 16"  
20 lbs. 8 cu. ft. 18 gauge



**7-PS-58 \$2760**

**Spacesaver With Side Splashes**  
7-3/4" Side Splashes  
1-1/2" Basket Drain  
Bowl Size: 9" x 9" x 5"  
Overall : 12-1/4" x 16"  
26 lbs. 8 cu. ft. 18 gauge



**7-PS-78 \$2666**

**Large Bowl Size**  
Bowl Size: 16" x 20" x 6"  
Overall : 24-3/4" x 21-7/8"  
40 lbs. 8 cu. ft. 18 gauge



**7-PS-82 \$2927**

**Towel & Soap Dispenser**  
Bowl Size: 10" x 14" x 5"  
Overall : 15-1/4" x 17-1/4"  
38 lbs. 6 cu. ft. 20 gauge

Upgrade To Touchless Soap Dispenser,  
Add 7-PS-104 **\$441**  
Plus 7-PS-120MIT (Deduct **-\$49**)

### You Can Put A Skirt On Any Handsink

(Excludes sinks with existing bases or skirts. Sinks Not Included)

**7-PS-31**  
**\$746**

Fits Hand Sinks  
with 10" x 14"  
Bowl and Splash  
Mounted Faucets

**7-PS-31A**  
**\$807**

Fits Hand Sinks  
with 9" x 9"  
Bowl Only

**7-PS-31B**  
**\$838**

Fits Hand Sinks  
with 10" x 14"  
Bowl and Deck  
Mounted Faucets

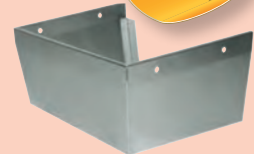

## KNEE & PEDAL VALVE REPLACEMENT PARTS & FAUCETS

### Foot Pedal Valve Replacement

Combo. H/C  
Single Pedal  
**K-103 \$669**

Foot Pedal with Retaining Pin Only  
**K-17 \$167**



### Knee Valve Replacement

Combo. H/C  
Single Pedal  
**K-104 \$840**

Knee Pedal with Retaining Pin Only  
**K-18 \$167**



**Splash Mounted  
Gooseneck  
Spout**

**K-121**  
**\$197**

### Foot Pedal Assembly w/Floor Bracket

**7-PS-39**  
**\$898**



### Knee Valve Assembly w/ Mounting Bracket

**7-PS-32**  
**\$1071**



### Replacement Check Valves

**K-19**  
**\$33 set of 2**



### Mixing Valve & Retainer

**K-19A**  
**\$28**



### Thermostatic Mixing Valve

**K-425**  
**\$543**



### Replacement Bonnet for Pedal/Knee Valve

(K-103 & K-104, 7-PS-32  
& 7-PS-39)

**K-01**  
**\$69**





All Sinks on this Page



All Sinks On This Page Ship Via UPS

# HANDS-FREE Hand Washing Sinks

## FOOT PEDAL VALVE UNITS

Includes Single Pedal Valve (With Built-In Mixing Valve), K-121 Splash Mt. Gooseneck Spout, 3-1/2" Basket Drain & Wall Bracket, Removable Panel for Plumbing Access



### 7-PS-90 \$2203

**Standard Unit**

Bowl Size:  
10" x 14" x 5"  
Overall :  
17-1/4" x 15-1/4" x 42"  
41 lbs. 10 cu. ft. 20 gauge



### 7-PS-96 \$2802

**Side Splash Unit**

7-3/4" High Side Splashes  
Bowl Size:  
10" x 14" x 5"  
Overall :  
17-1/4" x 15-1/4" x 42"  
41 lbs. 10 cu. ft. 20 gauge



### 7-PS-18 \$2647

**Large Bowl Size**

Bowl Size:  
16" (F/B) x 14" x 6"  
Overall :  
21-1/4" (F/B) x 17-1/4" x 42"  
50 lbs. 11 cu. ft. 18 gauge



### 7-PS-86 \$2752

**Extra Large Bowl Size**

Bowl Size:  
16" x 20" x 8"  
Overall :  
24-3/4" (F/B) x 21-7/8" x 41-1/2"  
55 lbs. 16 cu. ft. 20 gauge



Upgrade To Touchless Soap Dispenser,  
Add 7-PS-104 \$441  
Plus 7-PS-120MIT (Deduct -\$49)

### 7-PS-99 \$3984

**Towel & Soap Dispenser  
Trash Receptacle**

Bowl Size:  
10" (F/B)x 14" x 5"  
Overall :  
17-1/4" (F/B) x 15-1/4" x 42"  
59 lbs. 15 cu. ft. 20 gauge



### 7-PS-95 \$3201

**Towel & Soap Dispenser**

Bowl Size:  
10" (F/B) x 14" x 5"  
Overall :  
17-1/4" (F/B) x 15-1/4" x 42"  
54 lbs. 15 cu. ft. 20 gauge

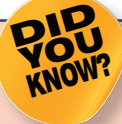

## You Can Put a Pedestal Base On Any Hand Sink

(Excludes Sinks With Existing Bases Or Skirts. Sinks Not Included)



### Basic Pedestal Base

7-PS-37 \$836

For 10" x 14" Bowls

7-PS-37B \$1047

For 10" x 14" bowls and  
Deck Mounted Faucets

7-PS-37C \$1120

For 16" x 20" Bowls



### With Foot Valve

7-PS-33 \$1164

For 10" x 14" Bowls

7-PS-33B \$1469

For 10" x 14" Bowls and  
Deck Mounted Faucets

7-PS-33C \$1585

For 16" x 20" Bowls



### Add Trash Receptacle

7-PS-29 \$948

Use above model number with  
any Pedestal Base Sink or  
Stand-Alone Pedestal Base.



Plastic Replacement  
Handles 7-PS-38 \$58

## SECURITY UNITS

Bowl Size: 10" x 14" x 5" • Require Minimum Security Installations  
Includes Heavy Duty Gooseneck Faucet, Concealed 3 1/2" Drain & Wall Bracket



### 7-PS-747 \$4329

**Class 2 Upgrade**  
45 lbs. 10 cu. ft. 20 gauge

### 7-PS-727 \$5500

**Class 1 Upgrade**  
Towel Dispenser  
Provisions For Installation Of Soap  
Dispenser (By Others)  
65 lbs. 15 cu. ft. 20 gauge



# HAND SINKS

## Hand Washing Sinks

All Sinks On This Page  
Ship Via UPS

**NSF** All Sinks on this Page

**DID YOU KNOW?**

You Can Add a K-175 or K-180 Electronic Faucet To Any Hand Sink \$2208  
(May require faucet hole revision. See Page 11.)



### CONCEALED HAND SINK DRAWER

Take Back Your Countertop Space!

- Easily Installs into Existing Advance Tabco Work Tables/Countertops or Integrates into Custom Fabrication
- Overall Size: 22 5/8" W x 19 7/8" L x 19 1/4" H"
- 10" x 14" x 5" Deep Sink Bowl
- Pre-Drilled Holes In Flanges For Easy Mounting
- Integral Drawer Slides For Smooth Operation
- "Safety Stop" Tab
- K-50 Swing Spout Faucet
- 1-1/2" Sink Drain with Strainer Plate
- Drainage Pan with 1-1/2" Drain & Strainer Plate (Drain Pipe & Fittings Included.)



**7-PS-47 \$3813**

70 lbs. 7 cu. ft.  
18 gauge exterior  
16 gauge interior



### A.D.A. UNITS FOR THE PHYSICALLY CHALLENGED

Bowl Size: 16" x 14" x 5". Overall Size: 20" x 24" • Includes 1-1/2" Drain With Strainer Plate & Wall Bracket



**7-PS-77-E \$5930**

**Tapered Bowl Design**  
Hands Free Operated Faucet  
Deck Mount Soap Dispenser  
16 Gauge Skirt with Enclosed Bottom  
w/ Removable Access Panel  
65 lbs. 8 cu. ft. 18 gauge

**7-PS-77-W \$3846**

Same As Above with  
4" O.C. Wrist Handle Faucet



**7-PS-41 \$6200**

**Tapered Bowl Design with Undermount Towel Dispenser**  
Hands Free Operated Faucet  
Deck Mount Soap Dispenser  
16 Gauge Skirt with Enclosed Bottom  
w/ Removable Access Panel  
65 lbs. 8 cu. ft. 18 gauge

**7-PS-46 \$4114**

Same As Above with  
4" O.C. Wrist Handle Faucet



**7-PS-25 \$2796**

K-208 Deck Mounted Faucet  
with Wrist Handles  
Deck Mounted Soap Dispenser  
Wall Support Brackets  
25 lbs. 8 cu. ft. 18 gauge

**7-PS-75 \$2174**

Same As 7-PS-25 With  
8" O.C. Faucet Holes Only  
(Faucet Not Included)

**7-PS-751 \$2174**

Same As 7-PS-75 With  
Single Hole (Faucet Not Included)

**7-PS-26 \$5235**

Same As 7-PS-25 With  
K-180 Hands Free AC/DC  
Operated Faucet  
Deck Mounted Soap  
Dispenser



### COUNTERTOP INSTALLED HAND SINKS

- 4" High Side Splashes
- K-52 Deck Mounted Faucet
- Deck Mounted Soap Dispenser
- Built-In Towel Dispenser
- 3-1/2" Basket Drain



**7-PS-42 \$3908**

Bowl Size: 10" x 14" x 5"  
Overall Size: 18-1/4" x 17-5/8"  
30 lbs. 2 cu. ft. 20 gauge



**7-PS-42A \$3908**

Bowl Size: 9" x 9" x 5"  
Overall Size: 17-3/8" x 13"  
26 lbs. 2 cu. ft. 20 gauge

- 4" High Side Splashes
- Deck Mounted Gooseneck Spout
- Knee Operated Valve
- Deck Mounted Soap Dispenser
- Built-In Towel Dispenser
- 3-1/2" Basket Drain

**7-PS-43 \$4524**

Bowl Size: 10" x 14" x 5"  
Overall Size: 18-1/4" x 17-5/8"  
36 lbs. 2 cu. ft. 20 gauge



Knee Valve Operated

For Factory Installation, Add TA-503 \$613. Can Be Purchased Separately For In-Field Installation

### LARGE SIZE SINK BOWLS

Includes K-59 Splash Mt. Gooseneck Faucet,  
3-1/2" Basket Drain, Wall Bracket  
w/ 2 Support Brackets



**7-PS-45 \$1455**

Bowl Size: 16" x 20" x 8"  
Overall Size: 24 3/4" x 21 7/8"  
31 lbs. 8 cu. ft. 18 gauge

**7-PS-49 \$1360**

Bowl Size: 14" x 16" x 8"  
Overall Size: 19-1/4" x 19"  
30 lbs. 8 cu. ft. 18 gauge



**7-PS-55 \$1526**

Gooseneck Faucet  
w/ Eye Wash Attachment  
15 lbs. 3 cu. ft. 20 gauge



**7-PS-72 \$1558**

H.A.C.C.P. Compliant  
Slow Self-Closing Metering  
Faucet with Mixing Valve  
15 lbs. 3 cu. ft. 20 gauge

Overall Size:  
17-1/4" x 17-1/4"



**7-PS-64 \$1360**

Splash Mounted  
Gooseneck Faucet  
Tubular Support Brackets  
25 lbs. 2 cu. ft. 20 gauge

PATENTED  
DESIGN



**7-PS-44 \$3573**

Body Activated Valve  
K-121 Splash Mounted  
Gooseneck Spout  
28 lbs. 2 cu. ft. 18 gauge

Overall Size:  
15-1/4" x 17-1/4"

### SPECIAL PURPOSE UNITS

Bowl Size: 10" x 14" x 5" • Overall Size: 15 1/4" x 17 1/4" (Excludes 7-PS-72 & 7-PS-44)  
Includes 3-1/2" Basket Drain & Wall Bracket



All Sinks on this Page

All Items On This Page Ship Via UPS

# HAND SINKS

## FAUCETS OMITTED

Bowl Size: 10" x 14" x 5". Overall Size: 15 1/4" x 17 1/4"



**7-PS-70 \$766**  
Equal To 7-PS-60 Without Faucet



**7-PS-71 \$842**  
Equal To 7-PS-70 With Single Hole Punch



**7-PS-20-NF \$835**  
Equal To 7-PS-20 Without Faucet



**7-PS-66-NF \$1386**  
Equal To 7-PS-66 Without Faucet

## HAND SINK FAUCETS & SPOUTS



**Extra Heavy Duty Splash Mounted Faucet K-69 \$651**  
4" O.C.  
Wrist Handles For K-69  
K-416-TS-LU \$492 set



**3-1/2" Splash Mounted Faucet K-59 \$331**  
4" O.C.

3-1/2" Splash Mounted Faucet with Wrist Handles

**K-316 \$496**  
4" O.C.



**Wrist Handles For Faucets (Excludes K-69) K-316-LU \$167 set**

3-1/2" Gooseneck Spouts



**Deck Mount K-120 \$300**

Deck Mounted Faucet



**K-22 \$304**  
4" O.C.

Splash Mounted K-121 \$197



## ELECTRONIC HANDS FREE FAUCETS



**Splash Mt. K-175 \$2208**

**Deck Mt. K-180 \$2208**

Powered by AC or Battery!

Replacement Control Module



**K-09 \$998**

Infra-Red Sensor and Wire Assembly



**K-14 \$165**

## "D" SPOUT EXTENDED FAUCETS



**Deck Mt. 6" Extended Spout K-124 \$479**  
4" O.C.



**Deck Mt. w/ Wrist Handles K-208 \$653**  
4" O.C.



**Splash Mt. 6" Extended Spout K-123 \$493**  
4" O.C.



**Splash Mt. w/ Wrist Handles K-206 \$624**  
4" O.C.

## SPECIALTY FAUCETS & ADAPTERS



**Slow-Released Metered Faucet K-190 \$804**



**Eye-Wash Attachment K-170 \$658**



**Hands-Free Wand Spout Not Included K-400 \$135 ea.**



**Low Flow Aerator .5 GPM K-08 \$50**

## REPLACEMENT CARTRIDGES WITH HANDLES\*

(Set of 2. Includes Cartridges and handles)

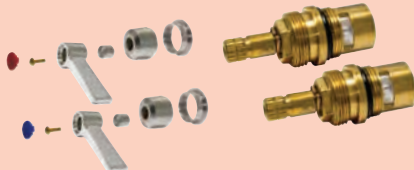

**For Faucets: K-59, K-123, K-125, K-126, K-206 & K-316 K-00A \$168**

**For Faucets: K-1, K-11, K-50, K-51, K-52, K-53, K-56, K-124, K-101, K-159, K-160, K-208 & K-240**

**K-00B \$168**

\*Can Only Be Used On Faucets Purchased After January 2016. For Older Faucets, Consult Customer Service.

## REPLACEMENT FAUCET SPOUTS

Model #	Spout Size/Style	For Faucet Model	Price
K-52SP	3-1/2" Swivel Gooseneck	K-52	<b>\$78</b>
K-55SP	8-1/2" Swivel Gooseneck	K-55	<b>124</b>
K-59SP	3-1/2" Swivel Gooseneck	K-59	<b>78</b>
K-208SP	6" Extended Swivel Gooseneck	K-208	<b>89</b>
K-175SP	4-1/2" Swivel Gooseneck	K-175/K-180	<b>185</b>
K-50SP	8" Swing Spout	K-50	<b>86</b>
K-53SP	12" Swing Spout	K-53	<b>116</b>

### Faucet Hole Modifications

Faucet Hole Modification	Faucet Not Included
K-70 Punch for 8" O.C. Faucet Holes	<b>\$176</b>
K-70A Punch for Single Hole Splash Mt. Faucet	<b>\$176</b>
K-71 Punch for Single Hole Deck Mt. Faucet	<b>\$176</b>

# MODS & ACCESSORIES

## Hand Sink Modifications & Accessories

 = Ships Via UPS

### WELDED SIDE SPLASHES FOR HAND SINKS

Factory Installed Only



7-3/4" Side Splash Shown



Two 7-3/4" Welded Side Splashes Shown



Two 12" Welded Side Splashes Shown

Shown with Optional Utility Tray



Two 24" Welded Side Splashes & Back Panel Shown

7-3/4" HEIGHT SPLASH		12" HEIGHT SPLASH				24" HEIGHT SPLASH		Description		
1 Side Splash	2 Side Splashes	1 Side Splash	2 Side Splashes	2 Side Splashes & Rear Panel*	Model #	Price				
Model #	Price	Model #	Price	Model #	Price	Model #	Price			
7-PS-16	\$521	7-PS-17	\$663	7-PS-11	\$634	7-PS-15	\$713	7-PS-28	\$1613	Units w/ 10" x 14" Bowl & Splash Mount Faucet
7-PS-16A	521	7-PS-17A	678	7-PS-11A	634	7-PS-15A	713	7-PS-28A	1613	Units w/ 9" x 9" Bowls
7-PS-16B	553	7-PS-17B	729	7-PS-11B	682	7-PS-15B	761	7-PS-28B	1629	Units w/ 10" x 14" Bowl & Deck Mount Faucet
7-PS-16C	567	7-PS-17C	760	7-PS-11C	713	7-PS-15C	790	7-PS-28C	1723	Units w/ 16" x 20" Bowls
7-PS-16D	615	7-PS-17D	794	7-PS-11D	771	7-PS-15D	879	7-PS-28D	1759	For Handicapped Hand Sinks
7-PS-16E	561	7-PS-17E	743	7-PS-11E	758	7-PS-15E	861	7-PS-28E	1680	Units w/ 14" (F/B) x 16" Bowls
7-PS-16F	561	7-PS-17F	743	7-PS-11F	758	7-PS-15F	861	7-PS-28F	1695	Units w/ 16" (F/B) x 14" Bowls

\*24" high splashes include a rear panel that matches the height of the side splashes. Only available as 2 side design. Single side not offered. Includes rear mounting holes.

### BOLT-ON SINGLE PANEL SPLASH FOR HAND SINKS

 All Bolt-On Splashes Ship Via UPS

#### 7-3/4" & 12" Height Bolt-On Splash

(Priced Per Splash. Order 2 for Both Sides)



Includes Holes. Hardware not Included

7-3/4" HEIGHT SPLASH		12" HEIGHT SPLASH		Description
Model #	Price Ea.	Model #	Price Ea.	
7-PS-27	\$209	7-PS-13	\$271	Units w/ 10" x 14" Bowl & Splash Mount Faucet
7-PS-27A	253	7-PS-13A	327	Units w/ 9" x 9" Bowls
7-PS-27B	253	7-PS-13B	362	Units w/ 10" x 14" Bowl & Deck Mount Faucet
7-PS-27C	253	7-PS-13C	377	Units w/ 16" x 20" Bowls
7-PS-27D	287	7-PS-13D	349	For Handicapped Hand Sinks
7-PS-27E	321	7-PS-13E	347	Units w/ 14" (F/B) x 16" Bowls
7-PS-27F	321	7-PS-13F	347	Units w/ 16" (F/B) x 14" Bowls



7-PS-25 Shown With Optional Side Splashes.

#### Removable Utility Tray for Side Splashes

- 8" X 3" X 2 5/16" Tray.
- Tray Hem Allows To Hang From Any Standard Side Splash.
- Perforated For Water Drainage.

7-PS-48 \$432 



#### Side Mounting Wall Brackets

Includes 2 brackets. Used for Added Strength & Support (Add to price of sink)

7-PS-36 \$195 



#### Tubular Wall Supports

Set of 2 Supports

Model #	Price	Description
7-PS-24	\$626	Units w/ 10"x14" Bowl & Splash Mt. Faucet
7-PS-24B	626	Units w/ 10"x14" Bowl & Deck Mt. Faucet
7-PS-24C	733	Units with 16"x14" & 16"x20" Bowls



# MODS & ACCESSORIES

## Hand Sink Modifications & Accessories

 All items On This Page Ship Via UPS

### Instant Hot Water

#### ON DEMAND

This unit allows for hand sinks to be installed in remote areas with just a cold water supply and available 30 amp electric power. There is no delay or wasted water while waiting for hot water to reach the faucet. Includes Heater & Plumbing Hardware.

7-PS-92 **\$2956**

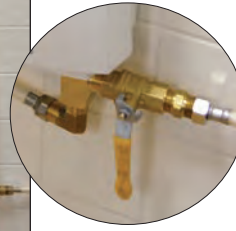

Only 1 Single Supply Line Of Cold Water Is Required To Feed The Unit!

**HANDSINK NOT INCLUDED**

## SOAP & TOWEL DISPENSERS



### C-Fold Style Paper Towel & Soap Dispenser

Mounts On 17" Wide Hand Sinks Only.

7-PS-34 **\$1517**

Upgrade To Touchless Soap Dispenser, Add 7-PS-104 **\$441**  
Plus 7-PS-120MIT (Deduct **-\$49**)



### Wall Mounted Liquid Soap Dispenser

Mounting Hardware Included.

7-PS-12 **\$253**



### Wall Mounted Touchless Liquid Soap Dispenser

Battery Powered (4 "AA" Batteries Required, Not Included). Mounting Hardware Included. Low Soap Indicator Window. Low Battery Indicator Light.

7-PS-104 **\$441**



### Wall Mounted Paper Towel Dispenser

Holds C-Fold Style Towels.

7-PS-35 **\$464**



### Deck Mounted Liquid Soap Dispenser

K-12 **\$211**



### Wall Mounted Stainless Steel Liquid Soap Dispenser

Mounting Hardware Included.

K-13 **\$575**

## DRAINS, PARTS & P-TRAPS



1-1/2" IPS

### 3-1/2" Basket Drain Assembly

K-6 **\$64**



1-1/2" IPS

### 2" Drain Assembly w/ Strainer Plate

K-63 **\$54**



### Drain Basket For K-6

K-310 **\$40**

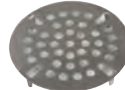

### Replacement Strainer Plates

for 3-1/2" Drain for 2" Drain  
K-410 **\$34** K-411 **\$32**



1-1/2" IPS

### Standard Chrome Plated P-Traps

22 Gauge  
7-PS-14 **\$166**

17 Gauge  
7-PS-10 **\$187**



### Replacement Washers for 3-1/2" Drains

K-67F **\$20** (Set of 2)

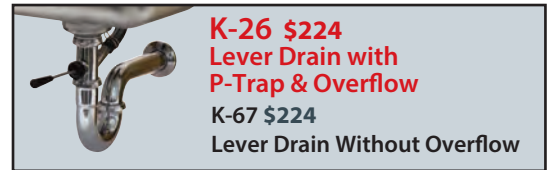

K-26 **\$224**  
Lever Drain with P-Trap & Overflow

K-67 **\$224**

Lever Drain Without Overflow

### REPLACEMENT PARTS FOR K-26 DRAIN



Model #	Description	Price
K-67A	Tail Piece with Overflow Branch Only	<b>\$39</b>
K-67B	Overflow Hose with 2 Spring Clips	<b>24</b>
K-67C	Plastic 90° Overflow Head & Body	<b>20</b>
K-67D	Lever Handle for K-26 Drain	<b>21</b>
K-67E	Plastic Stopper (Includes "O" Ring)	<b>20</b>

# MOP SINKS

## Floor Mop Sinks



### FLOOR UNITS Mounting Hardware Included

 = Ships Via UPS



Notched Out Front Allows Ease of Emptying Mop Bucket

Convert Mop Sink In Cabinet To Drop Front. Add K-281 \$1180 (Not Offered On 9-Op-40 Or 9-Op-48 Or 6" Deep Mop Sinks)

Model #	Bowl Size	Overall Dimension	Price	Approx. Wt.	Approx. Cu.
<b>STANDARD MOP SINKS</b> <small>NSF</small>					
9-OP-20	16" x 20" x 6"	21" x 25"	<b>\$2025</b>	33 lbs.	4 
9-OP-28	20" x 28" x 6"	25" x 33"	<b>2621</b>	47 lbs.	7 
9-OP-40	16" x 20" x 12"	21" x 25"	<b>2431</b>	45 lbs.	6 
9-OP-48	20" x 28" x 12"	25" x 33"	<b>2867</b>	62 lbs.	9
<b>LARGE MOP SINK BOWL</b>					
9-OP-44	24" x 24" x 12"	29" x 29"	<b>3595</b>	70 lbs.	9
9-OP-33	24" x 36" x 12"	29" x 41"	<b>5476</b>	80 lbs.	9
9-OP-34	24" x 24" x 12"	29" x 53"	<b>6567</b>	90 lbs.	9
<b>DROP-FRONT MOP SINKS</b>					
9-OP-40DF	16" x 20" x 12"	18 1/2" x 25"	<b>3831</b>	85 lbs.	9
9-OP-48DF	20" x 28" x 12"	22 1/2" x 33"	<b>4263</b>	110 lbs.	15

## Flush-Mount Floor Mop Sink

- Easy Mop Bucket Roll-In Design
- Standard Backsplash with Left & Right Splash, Left Splash or Right Splash Available
- 4" O.D. - 3" Long Plumbing Sleeve
- Front Anti-Splash Guard
- Removable Subway Grating
- Stainless Steel Strainer Basket with Handle

**FT-2 \$85 ea.**  
Replacement Stainless Steel Strainer Basket with Handle for Flush-Mount Floor Mop Sinks



9-OP-24FM-SSRL Shown



**K-610 Removable Stainless Steel Grid \$1066**

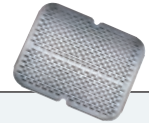





WITH STAINLESS STEEL GRATES			WITH FIBERGLASS GRATES			Bowl Size	Overall Dimension	Splash Locations	Approx. Cu.
Model #	Approx. Wt.	Price	Model #	Approx. Wt.	Price				
9-OP-24FM-SSRL	128 lbs.	<b>\$6469</b>	9-OP-24FM-FGRL	96 lbs.	<b>\$6469</b>	21 3/8" x 22 x 10"	21 3/8" x 24"	Back, Left & Right	14
9-OP-24FM-SSL	120 lbs.	<b>6249</b>	9-OP-24FM-FGL	88 lbs.	<b>6249</b>	21 3/8" x 22 x 10"	21 3/8" x 24"	Back & Left	14
9-OP-24FM-SSR	120 lbs.	<b>6249</b>	9-OP-24FM-FGR	88 lbs.	<b>6249</b>	21 3/8" x 22 x 10"	21 3/8" x 24"	Back & Right	14





## 16" HIGH SIDE & BACK SPLASHES FOR FLOOR MOP SINKS

16 Gauge, 300 Series Stainless Steel

### Splashes on All 3 Sides

Model #	Fits Units:	Model #	Fits Units:	Price
K-298	9-OP-20 9-OP-40	K-298D	9-OP-40DF	<b>\$954</b> 
K-299	9-OP-28 9-OP-48	K-299D	9-OP-48DF	<b>1026</b> 
K-300	9-OP-44	-	-	<b>1210</b> 
K-303	9-OP-33	-	-	<b>1284</b> 
K-304	9-OP-34	-	-	<b>1377</b> 

### Splash on Left or Right & Back

Model #	Fits Units:	Model #	Fits Units:	Price
K-288LorR	9-OP-20 9-OP-40	K-288LorRD	9-OP-40DF	<b>\$733</b> 
K-290LorR	9-OP-28 9-OP-48	K-290LorRD	9-OP-48DF	<b>800</b> 
K-291LorR	9-OP-44	-	-	<b>866</b> 
K-293LorR	9-OP-33	-	-	<b>910</b> 
K-294LorR	9-OP-34	-	-	<b>975</b> 



Left & Right Splashes Shown

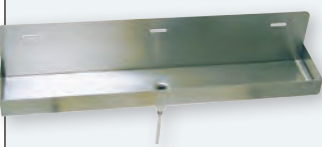

### Wall Mounted Drainage Tray K-243 \$740

- Used with Floor Mounted Mop Sinks
- 16 Gauge, 300 Series Stainless Steel
- Includes 1/2" Drain & Plastic Hose
- 2" Tray Ht. with 6" Rear Splash (O.A.)
- 20" x 4" x 6". 13 lbs.



**Hose & Hanger K-244 \$295**



**23" Mop Hanger K-242 \$321**



4-OP-18

**Fabricated Sink Bowl**



8-OP-16

**Deep Drawn Sink Bowl**

## STANDING SERVICE SINKS

Heavy Gauge Stainless Steel • 8" Bowl Depth • 8" High Backsplash • Stainless Steel Legs with Adjustable Bullet Feet  
• 8-OP-16 Includes Stainless Steel Cross-Bracing • 8" O.C. Faucet Holes • 3-1/2" Basket Drain

Model #	Bowl Size	Overall Dimension	Price	Approx. Wt.	Approx. Cu.
8-OP-16	16" x 20" x 8"	25" x 23"	<b>\$2235</b>	50 lbs.	13 
4-OP-18	24" x 21" x 8"	24" x 25"	<b>1526</b>	50 lbs.	10



# MOP SINKS

## Mop Sink Cabinets

### 84" HIGH STAINLESS STEEL MOP SINK CABINETS

 = Ships Via UPS



#### Single Width

- Single Left-Hinged Door\*
- 1 Fixed Stainless Steel Mid-Shelf
- Ventilation Slots
- 2 Mop Holders
- Open Back For Plumbing
- 16 Ga., Type 304 S/S Mop Sink & Drain

**16" x 20" x 12" Bowl**  
**Overall Size: 22-5/8" x 25" x 84"**



#### Double Width

- Hinged Double Doors
- Opening For Mop Bucket To Roll In
- 4 Fixed Stainless Steel Mid-Shelves (3 In Storage Side, 1 Above Sink)
- Enclosed Back Panel
- Ventilation Slots
- 2 Mop Holders
- Open Back For Plumbing
- 16 Ga., Type 304 S/S Mop Sink & Drain

**16" x 20" x 12" Bowl**  
**Overall Size: 22-5/8" x 50-1/4" x 84"**

9-OPC-84DR Shown

Model #	Cabinet Material	Price	Approx. Wt.	Approx. Cu.
9-OPC-84	18 Ga., 430 S/S	<b>\$10082</b>	238 lbs.	40
9-OPC-84-300	18 Ga., 300 S/S	<b>11712</b>	238 lbs.	40

\*Optional Right-Hand Door Swing Available - Add CAB-R N/C

**Convert Mop Sink In Cabinet To Drop Front. Add K-281 \$958**

Model #	Cabinet Material	Price	Approx. Wt.	Approx. Cu.
9-OPC-84DR	18 Ga., 430 S/S	<b>\$13723</b>	390 lbs.	72
9-OPC-84DL	18 Ga., 430 S/S	<b>13723</b>	390 lbs.	72
9-OPC-84DR-300	18 Ga., 300 S/S	<b>14388</b>	390 lbs.	72
9-OPC-84DL-300	18 Ga., 300 S/S	<b>14388</b>	390 lbs.	72

R And L Indicates Mop Sink Location.

#### Stainless Steel Cabinet with Floor



Sink Not Included

- Overall Size: 22-5/8" x 25" x 84"
- Single Left-Hinged Door\*
- Fixed Stainless Steel Mid-Shelves
- Enclosed Back Panel
- Ventilation Slots On Both Sides

Model #	# of Fixed Shelves	Price	Approx. Wt.	Approx. Cu.
18 Ga. CAB-1	1	<b>\$7361</b>	200 lbs.	40
430 S/S CAB-4	4	<b>8533</b>	240 lbs.	40
18 Ga. CAB-1-300	1	<b>8031</b>	200 lbs.	40
300 S/S CAB-4-300	4	<b>9368</b>	240 lbs.	40

\*Optional Right-Hand Door Swing Available - Add CAB-R N/C



#### CHEMICAL STORAGE CABINET

w/ 1 Fixed Stainless Steel Mid-Shelf

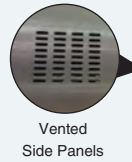

Vented Side Panels



WCH-15-24 Left Hinged Shown (Standard)

- Left-Hinged Door\*
- Vented Side Panels
- Wall Mounting Hardware Not Included

**WCH-15-24 \$6191**

18 Gauge, 430 Stainless Steel

**WCH-15-24-300 \$6860**

18 Gauge, 300 Stainless Steel

\*Optional Right-Hand Door Swing Available - Add CAB-R N/C

**Overall Size: 15" x 24" x 32-1/2"**

### MOP SINK CABINET ACCESSORIES & MODIFICATIONS



**Service Faucet For Mop Sinks**  
8" O.C.

**K-240\* \$1286**

\*K-240 Does Not Meet Federal Lead Free Standards As It Is Not Intended For Potable Water.



**Service Faucet Vacuum Breaker Repair Kit**  
**K-03 \$178**



**Mop Sink Replacement Drain**  
**K-16 \$248**

#### Double Cabinet Doors

Convert Single Width Cabinet to Double Doors  
**K-84-CAB \$987**

#### Add Rear Panel To Cabinet

**K-94-BACK \$678**  
**K-94-BACK-300 \$983**

Add K-472 for 8" O.C. Faucet Holes  
**\$143 Per Hole**



**Additional Fixed Mid-Shelf**  
**K-94-SHELF \$521 ea.**  
For 84" High Cabinets

**WC-SHELF \$125 lin. ft.**  
For Wall Cabinets

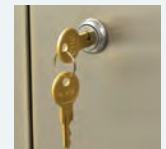

**Cabinet Door Lock With Keys**  
**SU-27 \$451**

Required For Each Hinged Door

**S-Hook Mop Hanger**  
**K-91 \$42 ea.**

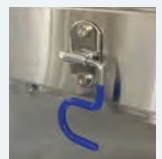

**WARNING:** Faucets on this page may expose you to chemicals, including lead, that are known to the State of California to cause cancer or birth defects or other reproductive harm. For more info, visit [www.p65warnings.ca.gov](http://www.p65warnings.ca.gov).

# MULTI-STATIONS

## NSF Multi-Stations



= Ships Via UPS

### 14 GAUGE, 304 STAINLESS STEEL SINKS WITH TUBULAR SUPPORTS OR LEGS

8" Bowl Depth • 8 1/2" High Backsplash • 8" O.C. Faucet Holes on Manual Operated, Single Holes on Knee or Electronic Operated • 3 1/2" Basket Drain(s).  
 "-F" Series Splash Mount Models Include K-159 3-1/2" Goosenecks. "-F" Series Deck Mount Models Include K-134 8-1/2" Goosenecks.



Faucets Included On "F" Models.



Hands-Free Electronic Faucet

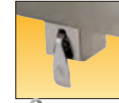

Knee Valve



FS-WM-40 Shown



FS-WM-40-F Shown



FS-WM-40EF Shown



FS-WM-40KV Shown

L	NO FAUCETS INCLUDED		MANUAL FAUCETS INCLUDED		ELECTRONIC OPERATED FAUCETS		KNEE OPERATED FAUCETS		# of Faucets
	Splash Mount	Price	Splash Mount	Price	Splash Mount	Price	Splash Mount	Price	
40"	FS-WM-40 <sup>†</sup>	\$5999	FS-WM-40-F	\$6725	FS-WM-40EF	\$9416	FS-WM-40KV	\$7856	2
60"	FS-WM-60 <sup>†</sup>	6673	FS-WM-60-F	7762	FS-WM-60EF	11789	FS-WM-60KV	9449	3
80"	FS-WM-80 <sup>†</sup>	7565	FS-WM-80-F	9016	FS-WM-80EF	14386	FS-WM-80KV	11266	4
100"	FS-WM-100 <sup>†</sup>	8295	FS-WM-100-F	10112	FS-WM-100EF	16825	FS-WM-100KV	12925	5
120"	FS-WM-120 <sup>†</sup>	10460	FS-WM-120-F	12638	FS-WM-120EF	20694	FS-WM-120KV	16014	6



### 14 GAUGE, 304 STAINLESS STEEL A.D.A. SINKS WITH TUBULAR SUPPORTS

5" Bowl Depth • 8 1/2" High Backsplash • 8" O.C. Faucet Holes on Manual Operated or Single Holes on Electronic Faucet Operated • Rear 3 1/2" Basket Drain(s).  
 "-F" Series Splash Mount Models Include K-161-LU 6" Goosenecks. "-F" Series Deck Mount Models Include K-134 8-1/2" Goosenecks.

L	NO FAUCETS INCLUDED		MANUAL FAUCETS INCLUDED		ELECTRONIC OPERATED FAUCETS		# of Faucets
	Splash Mount	Price	Splash Mount	Price	Splash Mount	Price	
40"	FS-WM-40-ADA <sup>†</sup>	\$5999	FS-WM-40-ADA-F	\$6864	FS-WM-40EFADA	\$9233	2
60"	FS-WM-60-ADA <sup>†</sup>	6673	FS-WM-60-ADA-F	8037	FS-WM-60EFADA	11591	3
80"	FS-WM-80-ADA <sup>†</sup>	7565	FS-WM-80-ADA-F	9417	FS-WM-80EFADA	14159	4
100"	FS-WM-100-ADA <sup>†</sup>	8295	FS-WM-100-ADA-F	10649	FS-WM-100EFADA	16575	5
120"	FS-WM-120-ADA <sup>†</sup>	10460	FS-WM-120-ADA-F	13411	FS-WM-120EFADA	20523	6



FS-WM-60EFADA Shown

<sup>†</sup>Add **K-472** For Faucet Hole Revision **\$176**

### 16 GAUGE, 304 STAINLESS STEEL SINKS WITH TUBULAR SUPPORTS OR LEGS

8" Bowl Depth • 8 1/2" High Backsplash • 8" O.C. Faucet Holes on Manual Operated, Single Holes on Knee or Electronic Operated • 3 1/2" Basket Drain(s).  
 "-F" Series Splash Mount Models Include K-159 3-1/2" Goosenecks. "-F" Series Deck Mount Models Include K-134 8-1/2" Goosenecks.

L	NO FAUCETS INCLUDED		MANUAL FAUCETS INCLUDED		ELECTRONIC OPERATED FAUCETS		KNEE OPERATED FAUCETS		# of Faucets
	Splash Mount	Price	Splash Mount	Price	Splash Mount	Price	Splash Mount	Price	
40"	FC-WM-40 <sup>†</sup>	\$5188	FC-WM-40-F	\$5914	FC-WM-40EF	\$8597	FC-WM-40KV	\$7040	2
60"	FC-WM-60 <sup>†</sup>	5855	FC-WM-60-F	6948	FC-WM-60EF	10973	FC-WM-60KV	8633	3
80"	FC-WM-80 <sup>†</sup>	6860	FC-WM-80-F	9417	FC-WM-80EF	13683	FC-WM-80KV	10564	4
100"	FC-WM-100 <sup>†</sup>	7697	FC-WM-100-F	9514	FC-WM-100EF	16224	FC-WM-100KV	12324	5
120"	FC-WM-120 <sup>†</sup>	9205	FC-WM-120-F	11384	FC-WM-120EF	19437	FC-WM-120KV	14758	6



### 16 GAUGE, 304 STAINLESS STEEL A.D.A. SINKS WITH TUBULAR SUPPORTS

5" Bowl Depth • 8 1/2" High Backsplash • 8" O.C. Faucet Holes on Manual Operated or Single Holes on Electronic Faucet Operated • Rear 3 1/2" Basket Drain(s).  
 "-F" Series Splash Mount Models Include K-161-LU 6" Goosenecks. "-F" Series Deck Mount Models Include K-134 8-1/2" Goosenecks.

L	NO FAUCETS INCLUDED		MANUAL FAUCETS INCLUDED		ELECTRONIC OPERATED FAUCETS		# of Faucets
	Splash Mount	Price	Splash Mount	Price	Splash Mount	Price	
40"	FC-WM-40-ADA <sup>†</sup>	\$5188	FC-WM-40-ADA-F	\$6127	FC-WM-40EFADA	\$8543	2
60"	FC-WM-60-ADA <sup>†</sup>	5855	FC-WM-60-ADA-F	7250	FC-WM-60EFADA	10804	3
80"	FC-WM-80-ADA <sup>†</sup>	6860	FC-WM-80-ADA-F	8610	FC-WM-80EFADA	13347	4
100"	FC-WM-100-ADA <sup>†</sup>	7697	FC-WM-100-ADA-F	10131	FC-WM-100EFADA	16058	5
120"	FC-WM-120-ADA <sup>†</sup>	9205	FC-WM-120-ADA-F	12158	FC-WM-120EFADA	19269	6



FC-WM-40EFADA Shown

<sup>†</sup>Add **K-472** For Faucet Hole Revision **\$176**

**WARNING:** Equipment that include faucets on this page may contain a chemical known to the State of California to cause cancer, birth defects or other reproductive harm.

 = Ships Via UPS



# SERVICE SINKS

## NSF Service Sinks

### 14 GAUGE, 304 STAINLESS STEEL SERVICE SINKS WITH TUBULAR SUPPORTS OR LEGS

10" or 12" Bowl Depth • 8-1/2" High Backsplash • 8" O.C. Faucet Holes on Manual Operated, Single Holes on Knee or Electronic Operated • 3 1/2" Basket Drain(s).  
 "F" Series Splash Mount Models Include K-159 3-1/2" Gooseneck. "F" Series Deck Mount Models Include K-134 8-1/2" Gooseneck.



NO FAUCET INCLUDED		MANUAL FAUCET INCLUDED		ELECTRONIC OPERATED FAUCET		KNEE OPERATED FAUCET		Bowl Depth	Overall Size	
Splash Mount	Price	Splash Mount	Price	Splash Mount	Price	Splash Mount	Price		L	W
FS-WM-2219 <sup>†</sup>	\$3238	FS-WM-2219-F	\$3488	FS-WM-2219EF	\$4946	FS-WM-2219KV*	\$4165	10"	23"	23"
FS-WM-2721 <sup>†</sup>	3447	FS-WM-2721-F	3685	FS-WM-2721EF	5151	FS-WM-2721KV*	4371	12"	27"	21 1/2"
FS-WM-3119 <sup>†</sup>	3791	FS-WM-3119-F	4055	FS-WM-3119EF	5665	FS-WM-3119KV*	4809	12"	31"	23"

\*Knee Valve Unit Has 8" Bowl Depth



### 14 GAUGE, 304 STAINLESS STEEL A.D.A. SERVICE SINKS WITH TUBULAR SUPPORTS

5" Bowl Depth • 8-1/2" High Backsplash • Stainless Steel Tubular Supports • 8" O.C. Faucet Holes on Manual Operated, Single Hole on Electronic Operated • 3 1/2" Basket Drain.  
 "F" Series Splash Mount Models Include K-161-LU 6" Gooseneck. "F" Series Deck Mount Models Include K-134 8-1/2" Gooseneck.

NO FAUCET INCLUDED		MANUAL FAUCET INCLUDED		ELECTRONIC OPERATED FAUCET		Bowl Depth	Overall Size	
Splash Mount	Price	Splash Mount	Price	Splash Mount	Price		L	W
FS-WM-1-ADA <sup>†</sup>	\$5363	FS-WM-1-ADA-F <sup>†</sup>	\$5602	FS-WM-1-EFADA	\$7068	5"	40"	19-1/2"

<sup>†</sup>Add K-472 For Faucet Hole Revision \$176



### 16 GAUGE, 304 STAINLESS STEEL SERVICE SINKS WITH TUBULAR SUPPORTS OR LEGS

10" or 12" Bowl Depth • 8-1/2" High Backsplash • 8" O.C. Faucet Holes on Manual Operated, Single Holes on Knee or Electronic Operated • 3 1/2" Basket Drain(s).  
 "F" Series Splash Mount Models Include K-159 3-1/2" Gooseneck. "F" Series Deck Mount Models Include K-134 8-1/2" Gooseneck.



NO FAUCET INCLUDED		MANUAL FAUCET INCLUDED		ELECTRONIC OPERATED FAUCET		KNEE OPERATED FAUCET		Bowl Depth	Overall Size	
Splash Mount	Price	Splash Mount	Price	Splash Mount	Price	Splash Mount	Price		L	W
FC-WM-2219 <sup>†</sup>	\$2875	FC-WM-2219-F	\$3297	FC-WM-2219EF	\$4582	FC-WM-2219KV*	\$3805	10"	23"	23"
FC-WM-2721 <sup>†</sup>	3028	FC-WM-2721-F	3451	FC-WM-2721EF	4733	FC-WM-2721KV*	3953	12"	27"	21 1/2"
FC-WM-3119 <sup>†</sup>	3337	FC-WM-3119-F	3799	FC-WM-3119EF	5206	FC-WM-3119KV*	4351	12"	31"	23"

\*Knee Valve Unit Has 8" Bowl Depth



### 16 GAUGE, 304 STAINLESS STEEL A.D.A. SERVICE SINKS WITH TUBULAR SUPPORTS

5" Bowl Depth • 8-1/2" High Backsplash • Stainless Steel Tubular Supports • 8" O.C. Faucet Holes on Manual Operated, Single Hole on Electronic Operated • 3 1/2" Basket Drain.  
 "F" Series Splash Mount Models Include K-161-LU 6" Gooseneck. "F" Series Deck Mount Models Include K-134 8-1/2" Gooseneck.

NO FAUCET INCLUDED		MANUAL FAUCET INCLUDED		ELECTRONIC OPERATED FAUCET		Bowl Depth	Overall Size	
Splash Mount	Price	Splash Mount	Price	Splash Mount	Price		L	W
FC-WM-1-ADA <sup>†</sup>	\$5085	FC-WM-1-ADA-F	\$5484	FC-WM-1-EFADA	\$6794	5"	40"	19 1/2"

<sup>†</sup>Add K-472 For Faucet Hole Revision \$176



**WARNING:** Equipment that include faucets on this page may contain a chemical known to the State of California to cause cancer, birth defects or other reproductive harm.

# MULTI-STATIONS

## Square Corner Multi-Stations

 = Ships Via UPS

### 16 GAUGE, 304 STAINLESS STEEL MULTI-STATIONS WITH TUBULAR SUPPORTS OR LEGS

8" Bowl Depth • 8 1/2" High Backsplash • 8" O.C. Faucet Holes on Manual Operated, Single Holes on Knee or Electronic Operated • 3 1/2" Basket Drain(s)



L	NO FAUCETS INCLUDED		MANUAL FAUCETS INCLUDED		ELECTRONIC OPERATED FAUCETS		KNEE OPERATED FAUCETS		# of Faucets	Wt.	Cu. Ft.
	Model #	Price	Model #	Price	Model #	Price	Model #	Price			
23"	19-18-23 <sup>†</sup>	\$2606	19-18-23-F	\$2967	19-18-23EF	\$4406	19-18-23KV	\$3628	1	50 lbs.	10
40"	19-18-40 <sup>†</sup>	4187	19-18-40-F	4914	19-18-40EF	7597	19-18-40KV	6037	2	60 lbs.	15
60"	19-18-60 <sup>†</sup>	4946	19-18-60-F	6035	19-18-60EF	10062	19-18-60KV	7722	3	70 lbs.	18
80"	19-18-80 <sup>†</sup>	5514	19-18-80-F	6969	19-18-80EF	12338	19-18-80KV	9217	4	90 lbs.	22
100"	19-18-100 <sup>†</sup>	6276	19-18-100-F	8092	19-18-100EF	14804	19-18-100KV	10904	5	120 lbs.	30
120"	19-18-120 <sup>†</sup>	7850	19-18-120-F	10029	19-18-120EF	18082	19-18-120KV	13402	6	155 lbs.	36

<sup>†</sup>Add **K-472** For Faucet Hole Revision **\$176**



### 16 GAUGE, 304 STAINLESS STEEL A.D.A. MULTI-STATIONS WITH TUBULAR SUPPORTS

5" Bowl Depth • 8 1/2" High Backsplash • 8" O.C. Faucet Holes on Manual Operated or Single Holes on Electronic Faucet Operated • Rear 3 1/2" Basket Drain(s)



L	NO FAUCETS INCLUDED		MANUAL FAUCETS INCLUDED		ELECTRONIC OPERATED FAUCETS		# of Faucets	Wt.	Cu. Ft.
	Model #	Price	Model #	Price	Model #	Price			
40"	19-18-40-ADA <sup>†</sup>	\$4187	19-18-40-ADA-F	\$5226	19-18-40EFADA	\$7597	2	60 lbs.	15
60"	19-18-60-ADA <sup>†</sup>	4946	19-18-60-ADA-F	6505	19-18-60EFADA	10062	3	70 lbs.	18
80"	19-18-80-ADA <sup>†</sup>	5514	19-18-80-ADA-F	7597	19-18-80EFADA	12338	4	100 lbs.	22
100"	19-18-100-ADA <sup>†</sup>	6276	19-18-100-ADA-F	8877	19-18-100EFADA	14804	5	130 lbs.	30
120"	19-18-120-ADA <sup>†</sup>	7850	19-18-120-ADA-F	10969	19-18-120EFADA	18082	6	165 lbs.	36

<sup>†</sup>Add **K-472** For Faucet Hole Revision **\$176**

**WARNING:** Equipment that includes a faucet may expose you to chemicals, including lead, that are known to the State of California to cause cancer or birth defects or other reproductive harm. For more Info., visit [www.p65warnings.ca.gov](http://www.p65warnings.ca.gov).

# SERVICE SINKS

## Square Corner Service Sinks

### 16 GAUGE, 304 STAINLESS STEEL SERVICE SINKS WITH TUBULAR SUPPORTS OR LEGS

12" Bowl Depth (Excludes Knee Valve Units\*) • 8 1/2" High Backsplash • 8" O.C. Faucet Holes on Manual Operated, Single Holes on Knee or Electronic Operated • 3 1/2" Basket Drain(s)



NO FAUCET INCLUDED		MANUAL FAUCET INCLUDED		ELECTRONIC OPERATED FAUCETS		KNEE OPERATED FAUCETS					Cu. Ft.
Model #	Price	Model #	Price	Model #	Price	Model #	Price	L	W	Wt.	
WSS-14-21 <sup>†</sup>	\$2739	WSS-14-21-F	\$3103	WSS-14-21EF	\$4444	WSS-14-21KV*	\$3665	18"	17 1/2"	45 lbs.	8
WSS-16-25 <sup>†</sup>	3025	WSS-16-25-F	3388	WSS-16-25EF	4730	WSS-16-25KV*	3951	22"	19 1/2"	52 lbs.	10
WSS-16-31 <sup>†</sup>	3326	WSS-16-31-F	3727	WSS-16-31EF	5206	WSS-16-31KV*	4347	31"	19 1/2"	75 lbs.	14

<sup>†</sup>Add **K-472** For Faucet Hole Revision **\$176**

\*Knee Valve Unit Has 8" Bowl Depth



### 16 GAUGE, 304 STAINLESS STEEL A.D.A. SERVICE SINKS WITH TUBULAR SUPPORTS

5" Bowl Depth • 8 1/2" High Backsplash • 8" O.C. Faucet Holes on Manual Operated, Single Holes on Electronic Operated • Rear 3 1/2" Basket Drain



NO FAUCET INCLUDED		MANUAL FAUCET INCLUDED		ELECTRONIC OPERATED FAUCETS					Cu. Ft.
Model #	Price	Model #	Price	Model #	Price	L	W	Wt.	
19-18-1-ADA <sup>†</sup>	\$4182	19-18-1-ADA-F	\$4703	19-18-1-EFADA	\$5807	40"	19 1/2"	60 lbs.	15

<sup>†</sup>Add **K-472** For Faucet Hole Revision **\$176**

### MULTI-STATION HAND SINK ACCESSORIES & MODIFICATIONS



Model	Description	Price	Model	Description	Price
K-6	3 1/2" Drain (1 1/2" I.P.S.)	\$64 ea.	K-1118	H.D. 8" Splash Mounted Faucet	536 ea.
K-13	Stainless Steel Soap Dispenser	575 ea.	K-316-LU	Wrist Handles	167 pair
K-101	8" Swing Spout Splash Mt. Faucet	316 ea.	K-472	Faucet Hole Revision (Manual Faucet Operated Sinks Only)	176
K-121	Single Hole, Splash Mounted 3-1/2" Gooseneck Spout	197 ea.	K-449	Reduce rear splash on ADA multi-station hand sink or service sink to 5" tall (top of splash 39" AFF if installed at ADA working height, allows ADA compliant mirror (by others) to be mounted over sink)	N/C
K-134	H.D. Deck Mounted 8-1/2" Gooseneck Faucet (8" O.C.)	861 ea.	K-508	Special Sizing Charge (Larger Size Cut Down To Smaller Size)	N/C
K-159	H.D. Splash Mounted 3-1/2" Gooseneck Faucet (8" O.C.)	627 ea.	TA-19	Adjustable Stainless Steel Flanged Bullet Foot	81 ea.
K-161-LU	H.D. Splash Mounted 6" Gooseneck Faucet (8" O.C.) With Wrist Handles	699 ea.			
K-411	Strainer Plate for 3-1/2" Drain	32 ea.			

**WARNING:** Equipment that includes a faucet may expose you to chemicals, including lead, that are known to the State of California to cause cancer or birth defects or other reproductive harm. For more info, visit [www.p65warnings.ca.gov](http://www.p65warnings.ca.gov).

# MULTI-STATIONS

## NSF Multi-Stations



= Ships Via UPS

### 14 GA., 304 STAINLESS STEEL SINKS w/STAINLESS STEEL LEGS & FLANGED FEET

8" Bowl Depth • 8 1/2" High Backsplash • 8" O.C. Faucet Holes on Manual Operated, Single Holes on Knee/Toe-Push or Electronic Operated  
 • Stainless Steel Flanged Feet • Wall Support Bracket • Side & Rear Cross-Bracing • 3 1/2" Basket Drain(s).  
 "F" Series Splash Mount Models Include K-159 3-1/2" Goosenecks. "F" Series Deck Mount Models Include K-134 8-1/2" Goosenecks.



FS-FM-40 Shown



FS-FM-40-F Shown



FS-FM-40EF Shown



FS-FM-40KV Shown



FS-FM-40FV Shown

L	NO FAUCETS INCLUDED		MANUAL FAUCETS INCLUDED		ELECTRONIC OPERATED FAUCETS		KNEE OPERATED FAUCETS		TOE-PUSH OPERATED FAUCETS		# of Faucets
	Splash Mount	Price	Splash Mount	Price	Splash Mount	Price	Splash Mount	Price	Splash Mount	Price	
40"	FS-FM-40 <sup>†</sup>	\$6609	FS-FM-40-F	\$7335	FS-FM-40EF	\$10027	FS-FM-40KV	\$8466	FS-FM-40FV	\$8928	2
60"	FS-FM-60 <sup>†</sup>	7432	FS-FM-60-F	8523	FS-FM-60EF	12549	FS-FM-60KV	9921	FS-FM-60FV	10209	3
80"	FS-FM-80 <sup>†</sup>	8477	FS-FM-80-F	9929	FS-FM-80EF	15299	FS-FM-80KV	11814	FS-FM-80FV	12179	4
100"	FS-FM-100 <sup>†</sup>	9511	FS-FM-100-F	11328	FS-FM-100EF	18041	FS-FM-100KV	13776	FS-FM-100FV	14142	5
120"	FS-FM-120 <sup>†</sup>	11982	FS-FM-120-F	14164	FS-FM-120EF	22217	FS-FM-120KV	16952	FS-FM-120FV	17537	6

### 14 GA., 304 STAINLESS STEEL A.D.A. SINKS w/STAINLESS STEEL LEGS & FLANGED FEET



5" Bowl Depth • 8 1/2" High Backsplash • 8" O.C. Faucet Holes on Manual Operated or Single Holes on Electronic Faucet Operated  
 • Stainless Steel Flanged Feet • Wall Support Bracket • Rear Cross-Bracing • 3 1/2" Basket Drain(s).  
 "F" Series Splash Mount Models Include K-161-LU 6" Goosenecks. "F" Series Deck Mount Models Include K-134 8-1/2" Goosenecks.

L	NO FAUCETS INCLUDED		MANUAL FAUCETS INCLUDED		ELECTRONIC OPERATED FAUCETS		# of Faucets
	Splash Mount	Price	Splash Mount	Price	Splash Mount	Price	
40"	FS-FM-40-ADA <sup>†</sup>	\$6609	FS-FM-40-ADA-F	\$7339	FS-FM-40EFADA	\$9711	2
60"	FS-FM-60-ADA <sup>†</sup>	7432	FS-FM-60-ADA-F	8644	FS-FM-60EFADA	12197	3
80"	FS-FM-80-ADA <sup>†</sup>	8477	FS-FM-80-ADA-F	10175	FS-FM-80EFADA	16239	4
100"	FS-FM-100-ADA <sup>†</sup>	9511	FS-FM-100-ADA-F	11712	FS-FM-100EFADA	17639	5
120"	FS-FM-120-ADA <sup>†</sup>	11982	FS-FM-120-ADA-F	14673	FS-FM-120EFADA	21786	6

<sup>†</sup>Add **K-472** For Faucet Hole Revision **\$176**



FS-FM-40EFADA Shown

### 16 GA., 304 STAINLESS STEEL SINKS WITH STAINLESS STEEL LEGS & FLANGED FEET

8" Bowl Depth • 8 1/2" High Backsplash • 8" O.C. Faucet Holes on Manual Operated, Single Holes on Knee/Toe-Push or Electronic Operated  
 • Stainless Steel Flanged Feet • Wall Support Bracket • Side & Rear Cross-Bracing • 3 1/2" Basket Drain(s).  
 "F" Series Splash Mount Models Include K-159 3-1/2" Goosenecks. "F" Series Deck Mount Models Include K-134 8-1/2" Goosenecks.

L	NO FAUCETS INCLUDED		MANUAL FAUCETS INCLUDED		ELECTRONIC OPERATED FAUCETS		KNEE OPERATED FAUCETS		TOE-PUSH OPERATED FAUCETS		# of Faucets
	Splash Mount	Price	Splash Mount	Price	Splash Mount	Price	Splash Mount	Price	Splash Mount	Price	
40"	FC-FM-40 <sup>†</sup>	\$5798	FC-FM-40-F	\$6523	FC-FM-40EF	\$9208	FC-FM-40KV	\$7413	FC-FM-40FV	\$7648	2
60"	FC-FM-60 <sup>†</sup>	6619	FC-FM-60-F	7708	FC-FM-60EF	11734	FC-FM-60KV	8910	FC-FM-60FV	9394	3
80"	FC-FM-80 <sup>†</sup>	7773	FC-FM-80-F	9227	FC-FM-80EF	14596	FC-FM-80KV	10822	FC-FM-80FV	11477	4
100"	FC-FM-100 <sup>†</sup>	8916	FC-FM-100-F	10732	FC-FM-100EF	17443	FC-FM-100KV	12570	FC-FM-100FV	13544	5
120"	FC-FM-120 <sup>†</sup>	10727	FC-FM-120-F	12907	FC-FM-120EF	20962	FC-FM-120KV	14969	FC-FM-120FV	16282	6

### 16 GA., 304 STAINLESS STEEL A.D.A. SINKS w/STAINLESS STEEL LEGS & FLANGED FEET



5" Bowl Depth • 8 1/2" High Backsplash • 8" O.C. Faucet Holes on Manual Operated or Single Holes on Electronic Faucet Operated  
 • Stainless Steel Flanged Feet • Wall Support Bracket • Rear Cross-Bracing • 3 1/2" Basket Drain(s).  
 "F" Series Splash Mount Models Include K-161-LU 6" Goosenecks. "F" Series Deck Mount Models Include K-134 8-1/2" Goosenecks.

L	NO FAUCETS INCLUDED		MANUAL FAUCETS INCLUDED		ELECTRONIC OPERATED FAUCETS		# of Faucets
	Splash Mount	Price	Splash Mount	Price	Splash Mount	Price	
40"	FC-FM-40-ADA <sup>†</sup>	\$5798	FC-FM-40-ADA-F	\$6603	FC-FM-40EFADA	\$8974	2
60"	FC-FM-60-ADA <sup>†</sup>	6619	FC-FM-60-ADA-F	7857	FC-FM-60EFADA	11414	3
80"	FC-FM-80-ADA <sup>†</sup>	7773	FC-FM-80-ADA-F	9365	FC-FM-80EFADA	14106	4
100"	FC-FM-100-ADA <sup>†</sup>	8916	FC-FM-100-ADA-F	11197	FC-FM-100EFADA	17123	5
120"	FC-FM-120-ADA <sup>†</sup>	10727	FC-FM-120-ADA-F	13420	FC-FM-120EFADA	20532	6

<sup>†</sup>Add **K-472** For Faucet Hole Revision **\$176**



FC-FM-40-EFADA Shown

 = Ships Via UPS



# SERVICE SINKS

## NSF Service Sinks

### 14 GA., 304 STAINLESS STEEL SERVICE SINKS w/STAINLESS STEEL LEGS & FLANGED FEET

10" or 12" Bowl Depth • 8-1/2" High Backsplash • 8" O.C. Faucet Holes on Manual Operated, Single Holes on Knee/Toe-Push or Electronic Operated  
 • Stainless Steel Flanged Feet • Wall Support Bracket • Side & Rear Cross-Bracing 3 1/2" Basket Drain(s)  
 "F" Series Splash Mount Models Include K-159 3-1/2" Gooseneck. "F" Series Deck Mount Models Include K-134 8-1/2" Gooseneck.



FS-FM-2219 Shown



FS-FM-2219-F Shown



FS-FM-2219EF Shown



FS-FM-2219KV Shown



FS-FM-2219FV Shown

NO FAUCET INCLUDED		MANUAL FAUCETS INCLUDED		ELECTRONIC OPERATED FAUCETS		KNEE OPERATED FAUCETS		TOE-PUSH OPERATED FAUCETS		Bowl Depth	Overall Size	
Splash Mount	Price	Splash Mount	Price	Splash Mount	Price	Splash Mount	Price	Splash Mount	Price		L	W
FS-FM-2219 <sup>†</sup>	\$3840	FS-FM-2219-F	\$4261	FS-FM-2219EF	\$5545	FS-FM-2219KV*	\$4767	FS-FM-2219FV	\$5237	10"	23"	23"
FS-FM-2721 <sup>†</sup>	4046	FS-FM-2721-F	4467	FS-FM-2721EF	5751	FS-FM-2721KV*	4971	FS-FM-2721FV	5444	12"	27"	21 1/2"
FS-FM-3119 <sup>†</sup>	4450	FS-FM-3119-F	4916	FS-FM-3119EF	6327	FS-FM-3119KV*	5471	FS-FM-3119FV	5986	12"	31"	23"

\*Knee Valve Unit Has 8" Bowl Depth

### 14 GA., 304 STAINLESS STEEL A.D.A. SERVICE SINKS w/STAINLESS STEEL LEGS & FLANGED FEET



5" Bowl Depth • 8-1/2" High Backsplash • 8" O.C. Faucet Holes on Manual Operated, Single Hole on Electronic Operated  
 • Stainless Steel Flanged Feet • Wall Support Bracket • Rear Cross-Bracing • 3 1/2" Basket Drain(s).

"F" Series Splash Mount Models Include K-161-LU 6" Gooseneck. "F" Series Deck Mount Models Include K-134 8-1/2" Gooseneck.



FS-FM-1-ADA Shown

NO FAUCET INCLUDED		MANUAL FAUCET INCLUDED		ELECTRONIC OPERATED FAUCET		Bowl Depth	Overall Sizes	
Splash Mount	Price	Deck Mount	Price	Splash Mount	Price		L	W
FS-FM-1-ADA <sup>†</sup>	\$5840	FS-FM-1-ADA-F	\$6361	FS-FM-1-EFADA	\$7545	5"	40"	19-1/2"

<sup>†</sup>Add K-472 For Faucet Hole Revision \$176

### 16 GA., 304 STAINLESS STEEL SERVICE SINKS w/STAINLESS STEEL LEGS & FLANGED FEET

10" or 12" Bowl Depth • 8-1/2" High Backsplash • 8" O.C. Faucet Holes on Manual Operated, Single Holes on Knee/Toe-Push or Electronic Operated  
 • Stainless Steel Flanged Feet • Wall Support Bracket • Side & Rear Cross-Bracing • 3 1/2" Basket Drain(s).

Gooseneck Faucet Included On "F" Series Sinks. Splash Mt. Models Include 3-1/2" Gooseneck, Deck Mt. Models Include 6" Gooseneck.



FC-FM-2219 Shown



FC-FM-2219-F Shown



FC-FM-2219EF Shown



FC-FM-2219KV Shown



FC-FM-2219FV Shown



Toe-Push Valve

NO FAUCET INCLUDED		MANUAL FAUCET INCLUDED		ELECTRONIC OPERATED FAUCET		KNEE OPERATED FAUCET		TOE-PUSH OPERATED FAUCETS		Bowl Depth	Overall Sizes	
Splash Mount	Price	Splash Mount	Price	Splash Mount	Price	Splash Mount	Price	Splash Mount	Price		L	W
FC-FM-2219 <sup>†</sup>	\$3478	FC-FM-2219-F	\$3900	FC-FM-2219EF	\$5182	FC-FM-2219KV*	\$4274	FC-FM-2219FV	\$4844	10"	23"	19 1/2"
FC-FM-2721 <sup>†</sup>	3630	FC-FM-2721-F	4052	FC-FM-2721EF	5333	FC-FM-2721KV*	4554	FC-FM-2721FV	5001	12"	27"	21 1/2"
FC-FM-3119 <sup>†</sup>	4450	FC-FM-3119-F	4458	FC-FM-3119EF	5009	FC-FM-3119KV*	5009	FC-FM-3119FV	5501	12"	31"	23"

\*Knee Valve Unit Has 8" Bowl Depth

### 16 GA., 304 STAINLESS STEEL A.D.A. SERVICE SINKS w/STAINLESS STEEL LEGS & FLANGED FEET



5" Bowl Depth • 8-1/2" High Backsplash • 8" O.C. Faucet Holes on Manual Operated, Single Hole on Electronic Operated  
 • Stainless Steel Flanged Feet • Wall Support Bracket • Rear Cross-Bracing • 3 1/2" Basket Drain(s).

"F" Series Splash Mount Models Include K-161-LU 6" Gooseneck. "F" Series Deck Mount Models Include K-134 8-1/2" Gooseneck.



FC-FM-1-EFADA Shown

NO FAUCET INCLUDED		MANUAL FAUCET INCLUDED		ELECTRONIC OPERATED FAUCET		Bowl Depth	Overall Sizes	
Splash Mount	Price	Splash Mount	Price	Model #	Price		L	W
FC-FM-1-ADA <sup>†</sup>	\$5564	FC-FM-1-ADA-F	\$6084	FC-FM-1-EFADA	\$7269	5"	40"	19 1/2"

<sup>†</sup>Add K-472 For Faucet Hole Revision \$176

**WARNING:** Equipment that include faucets on this page may contain a chemical known to the State of California to cause cancer, birth defects or other reproductive harm.

# MULTI-STATIONS

## Square Corner Multi-Stations

 = Ships Via UPS

### 16 GA., 304 STAINLESS STEEL MULTI-STATIONS W/STAINLESS STEEL LEGS & FLANGED FEET

8" Bowl Depth • 8 1/2" High Backsplash • 8" O.C. Faucet Holes on Manual Operated, Single Holes on Knee/Toe-Push or Electronic Operated  
 • Stainless Steel Flanged Feet • Wall Support Bracket • Side & Rear Cross-Bracing • 3 1/2" Basket Drain(s)



Toe-Push Valve

L	NO FAUCETS INCLUDED		MANUAL FAUCETS INCLUDED		ELECTRONIC OPERATED FAUCETS		KNEE OPERATED FAUCETS		TOE-PUSH OPERATED FAUCETS		# of Faucets	Wt.	Cu. Ft.
	Model #	Price	Model #	Price	Model #	Price	Model #	Price	Model #	Price			
23"	19-FM-23 <sup>†</sup>	\$3204	19-FM-23-F	\$3568	19-FM-23EF	\$5008	19-FM-23KV	\$4099	19-FM-23FV	\$4227	1	50 lbs.	10
40"	19-FM-40 <sup>†</sup>	4795	19-FM-40-F	5521	19-FM-40EF	8205	19-FM-40KV	6411	19-FM-40FV	6645	2	60 lbs.	15
60"	19-FM-60 <sup>†</sup>	5705	19-FM-60-F	6796	19-FM-60EF	10822	19-FM-60KV	7999	19-FM-60FV	8481	3	70 lbs.	18
80"	19-FM-80 <sup>†</sup>	6273	19-FM-80-F	7726	19-FM-80EF	13248	19-FM-80KV	9477	19-FM-80FV	10130	4	90 lbs.	22
100"	19-FM-100 <sup>†</sup>	7492	19-FM-100-F	9309	19-FM-100EF	16020	19-FM-100KV	11147	19-FM-100FV	12122	5	120 lbs.	30
120"	19-FM-120 <sup>†</sup>	9372	19-FM-120-F	11552	19-FM-120EF	19608	19-FM-120KV	13614	19-FM-120FV	14929	6	155 lbs.	36

<sup>†</sup>Add **K-472** For Faucet Hole Revision **\$176**

### 16 GAUGE, 304 STAINLESS STEEL A.D.A. MULTI-STATIONS WITH TUBULAR SUPPORTS



5" Bowl Depth • 8 1/2" High Backsplash • 8" O.C. Faucet Holes on Manual Operated or Single Holes on Electronic Faucet Operated  
 • Stainless Steel Flanged Feet • Wall Support Bracket • Rear Cross-Bracing • 3 1/2" Basket Drain(s)

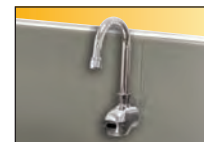

Hands-Free Electronic Faucet

L	NO FAUCETS INCLUDED		MANUAL FAUCETS INCLUDED		ELECTRONIC OPERATED FAUCETS		# of Faucets	Wt.	Cu. Ft.
	Model #	Price	Model #	Price	Model #	Price			
40"	19-FM-40-ADA <sup>†</sup>	\$4795	19-FM-40-ADA-F	\$5789	19-FM-40EFADA	\$8072	2	60 lbs.	15
60"	19-FM-60-ADA <sup>†</sup>	5705	19-FM-60-ADA-F	7267	19-FM-60EFADA	10604	3	70 lbs.	18
80"	19-FM-80-ADA <sup>†</sup>	6273	19-FM-80-ADA-F	8509	19-FM-80EFADA	13097	4	100 lbs.	22
100"	19-FM-100-ADA <sup>†</sup>	7492	19-FM-100-ADA-F	10095	19-FM-100EFADA	15865	5	130 lbs.	30
120"	19-FM-120-ADA <sup>†</sup>	9372	19-FM-120-ADA-F	12495	19-FM-120EFADA	19344	6	165 lbs.	36

<sup>†</sup>Add **K-472** For Faucet Hole Revision **\$176**



# SERVICE SINKS

## Square Corner Service Sinks

### 16 GAUGE, 304 STAINLESS STEEL SERVICE SINKS W/STAINLESS STEEL LEGS & FLANGED FEET

12" Bowl Depth (Excludes Knee Valve Units) • 8 1/2" High Backsplash • 8" O.C. Faucet Holes on Manual Operated, Single Holes on Knee/Toe-Push or Electronic Operated  
 • Stainless Steel Flanged Feet • Wall Support Bracket • Side & Rear Cross-Bracing • 3 1/2" Basket Drain(s)



Toe-Push Valve

WSS-14-21-FM Shown    WSS-14-21-FM-F Shown    WSS-14-21EF-FM Shown    WSS-14-21KV-FM Shown    WSS-14-21FV-FM Shown

NO FAUCET INCLUDED		MANUAL FAUCET INCLUDED		ELECTRONIC OPERATED FAUCETS		KNEE OPERATED FAUCETS		TOE-PUSH OPERATED FAUCETS		L	W	Wt.	Cu. Ft.
Model #	Price	Model #	Price	Model #	Price	Model #	Price	Model #	Price				
WSS-14-21-FM <sup>†</sup>	\$3340	WSS-14-21-FM-F	\$3703	WSS-14-21EF-FM	\$5044	WSS-14-21KV-FM*	\$4135	WSS-14-21FV-FM	\$4265	18"	17-1/2"	45 lbs.	8
WSS-16-25-FM <sup>†</sup>	3626	WSS-16-25-FM-F	3988	WSS-16-25EF-FM	5331	WSS-16-25KV-FM*	4551	WSS-16-25FV-FM	5039	22"	19-1/2"	52 lbs.	10
WSS-16-31-FM <sup>†</sup>	3988	WSS-16-31-FM-F	4388	WSS-16-31EF-FM	5864	WSS-16-31KV-FM*	5008	WSS-16-31FV-FM	5544	31"	19-1/2"	58 lbs.	11

<sup>†</sup>Add **K-472** For Faucet Hole Revision **\$176**

\*Knee Valve Unit Has 8" Bowl Depth

### 16 GAUGE, 304 STAINLESS STEEL A.D.A. SERVICE SINKS WITH TUBULAR SUPPORTS



5" Bowl Depth • 8 1/2" High Backsplash • 8" O.C. Faucet Holes on Manual Operated, Single Holes on Electronic Operated  
 • Stainless Steel Flanged Feet • Wall Support Bracket • Rear Cross-Bracing • 3 1/2" Basket Drain(s)

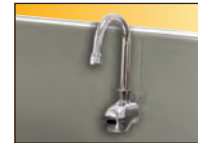

Hands-Free Electronic Faucet

19-FM-1-ADA Shown    19-FM-1-ADA-F Shown    19-FM-1-EFADA Shown

NO FAUCET INCLUDED		MANUAL FAUCET INCLUDED		ELECTRONIC OPERATED FAUCET		L	W	Wt.	Cu. Ft.
Model #	Price	Model #	Price	Model #	Price				
19-FM-1-ADA <sup>†</sup>	\$4659	19-FM-1-ADA-F <sup>†</sup>	\$5082	19-FM-1-EFADA	\$6283	40"	19 1/2"	60 lbs.	15

<sup>†</sup>Add **K-472** For Faucet Hole Revision **\$176**

### MULTI-STATION HAND SINK ACCESSORIES & MODIFICATIONS



Model	Description	Price	Model	Description	Price
K-6	3 1/2" Drain (1 1/2" I.P.S.)	\$64 ea.	K-1118	Extra H.D. 8" Splash Mounted Faucet	512 ea.
K-13	Stainless Steel Soap Dispenser	575 ea.	K-316-LU	Wrist Handles	161 pair
K-101	8" Swing Spout Splash Mt. Faucet	316 ea.	K-472	Faucet Hole Revision (Manual Faucet Operated Sinks Only)	176
K-121	Single Hole, Splash Mounted 3-1/2" Gooseneck Spout	197 ea.	K-449	Reduce rear splash on ADA multi-station hand sink or service sink to 5" tall (top of splash 39" AFF if installed at ADA working height, allows ADA compliant mirror (by others) to be mounted over sink)	N/C
K-134	Deck Mounted 8-1/2" Gooseneck Faucet (8" O.C.)	861 ea.	K-508	Special Sizing Charge (Larger Size Cut Down To Smaller Size)	N/C
K-159	Splash Mounted 3-1/2" Gooseneck Faucet (8" O.C.)	627 ea.	TA-19	Adjustable Stainless Steel Flanged Bullet Foot	78 ea.
K-161-LU	Splash Mounted 6" Gooseneck Faucet (8" O.C.) With Wrist Handles	699 ea.			
K-411	Strainer Plate for 3-1/2" Drain	32 ea.			

**WARNING:** Equipment that includes a faucet may expose you to chemicals, including lead, that are known to the State of California to cause cancer or birth defects or other reproductive harm. For more info., visit [www.p65warnings.ca.gov](http://www.p65warnings.ca.gov).

# REGALINE

## Deep Drawn Sinks



**Deep Drawn Bowls Are Seamless And Drawn Out of a Single Sheet of Steel**

ALL MODELS INCLUDE  
STAINLESS STEEL LEGS  
& BULLET FEET

Now All Adjustable Cross Bracing!



94 Series



93 & 9 Series

### Features and Benefits

- 3" Large Radius Corners
- Easy to Clean
- Satin Finish
- No Welded Seams



<p><b>SPEC-LINE "94" Series</b></p> <ul style="list-style-type: none"> <li>• 14 ga. 304 Stainless Steel</li> <li>• Stainless Steel Adjustable Cross Bracing On Front and Sides</li> <li>• 16 ga. 304 Stainless Steel Legs &amp; Bullet Feet</li> <li>• 11" Backsplash</li> <li>• 14" Deep Sink Bowls</li> </ul>	<p><b>THE ONLY 14 GAUGE Deep Drawn SINK!</b></p>	<p><b>STANDARD "93" Series</b></p> <ul style="list-style-type: none"> <li>• 16 ga. 304 Stainless Steel</li> <li>• Stainless Steel Adjustable Side Cross Bracing</li> <li>• Stainless Steel Legs and Bullet Feet</li> <li>• 8" Backsplash</li> <li>• 12" Deep Sink Bowls</li> </ul>	<p><b>SUPERSAVER "9" Series</b></p> <ul style="list-style-type: none"> <li>• 18 ga. 304 Stainless Steel</li> <li>• Stainless Steel Adjustable Side Cross Bracing</li> <li>• Stainless Steel Legs and Bullet Feet</li> <li>• 8" Backsplash</li> <li>• 12" Deep Sink Bowls</li> </ul>
---	--	--	---

## ONE, TWO, THREE AND FOUR COMPARTMENTS with No Drainboards



94 Series Shown



### Spec-Line 94 Series

### Standard 93 Series

### Super Saver 9 Series

14 Ga. 304 S/S 14" Water Level	16 Ga. 304 S/S 12" Water Level	18 Ga. 304 S/S 12" Water Level
-----------------------------------	-----------------------------------	-----------------------------------

Bowl Size	O.A. Length	# of Comp.	Spec-Line 94 Series			Standard 93 Series			Super Saver 9 Series			
			Model #	Price	Approx. Wt. (lbs.)	Model #	Price	Approx. Wt. (lbs.)	Model #	Price	Approx. Wt. (lbs.)	Cu. Ft.
<b>16" x 20"</b>	25"	One	94-1-24	\$5404	77	93-1-24	\$3512	62	9-1-24	\$3222	54	20
	44"	Two	94-2-36	7013	109	93-2-36	4815	76	9-2-36	4412	66	20
	62"	Three	94-3-54	8665	142	93-3-54	6096	107	9-3-54	5587	95	28
	*81"	Four	94-4-72	11079	225	93-4-72	7882	176	9-4-72	7234	155	44
<b>20" x 20"</b>	29"	One	94-21-20	5904	92	93-21-20	3829	80	9-21-20	3771	61	20
	52"	Two	94-22-40	7700	116	93-22-40	5298	92	9-22-40	4858	79	23
	74"	Three	94-23-60	9911	232	93-23-60	7022	188	9-23-60	6435	169	44
	*97"	Four	94-24-80	12458	285	93-24-80	8971	210	9-24-80	8250	192	56
<b>18" x 24"</b>	27"	One	94-61-18	6139	95	93-61-18	4116	84	9-61-18	3802	78	24
	48"	Two	94-62-36	7876	165	93-62-36	5545	144	9-62-36	5122	132	26
	68"	Three	94-63-54	10029	249	93-63-54	7217	203	9-63-54	6651	188	36
	89"	Four	94-64-72	12500	312	93-64-72	9110	264	9-64-72	8415	255	56
<b>24" x 24"</b>	33"	One	94-41-24	6325	97	93-41-24	4435	85	9-41-24	4070	80	23
	60"	Two	94-42-48	9151	174	93-42-48	6684	145	9-42-48	6130	133	31
	*86"	Three	94-43-72	11529	252	93-43-72	8752	213	9-43-72	8028	200	56
	*113"	Four	94-44-96	14330	347	93-44-96	11232	302	9-44-96	10292	281	74
<b>20" x 28"</b>	29"	One	94-81-20	6972	134	93-81-20	4616	94	9-81-20	4220	82	27
	52"	Two	94-82-40	9175	176	93-82-40	6779	150	9-82-40	6213	138	45
	74"	Three	94-83-60	11877	255	93-83-60	9052	225	9-83-60	8296	216	65
	*97"	Four	94-84-80	15156	345	93-84-80	11703	310	9-84-80	10715	287	78



# REGALINE

## Deep Drawn Sinks



94 Series Shown

### ONE COMPARTMENT WITH TWO DRAINBOARDS

#### Spec-Line 94 Series

#### Standard 93 Series

#### Super Saver 9 Series

14 Ga. 304 S/S 14" Water Level	16 Ga. 304 S/S 12" Water Level	18 Ga. 304 S/S 12" Water Level
-----------------------------------	-----------------------------------	-----------------------------------

Bowl Size	O.A. Length	DRBD. Size	Spec-Line 94 Series			Standard 93 Series			Super Saver 9 Series			Cu. Ft.
			Model #	Price	Approx. Wt. (lbs.)	Model #	Price	Approx. Wt. (lbs.)	Model #	Price	Approx. Wt. (lbs.)	
<b>16" x 20"</b>	54"	18"	94-1-24-18RL	\$5798	97	93-1-24-18RL	\$5042	82	9-1-24-18RL	\$4782	71	29
	66"	24"	94-1-24-24RL	6028	118	93-1-24-24RL	5204	95	9-1-24-24RL	4811	95	33
	90"	36"	94-1-24-36RL	6626	164	93-1-24-36RL	5583	134	9-1-24-36RL	5108	134	48
<b>20" x 20"</b>	58"	18"	94-21-20-18RL	6367	95	93-21-20-18RL	5523	78	9-21-20-18RL	5023	78	26
	70"	24"	94-21-20-24RL	6569	117	93-21-20-24RL	5574	92	9-21-20-24RL	5133	92	34
	94"	36"	94-21-20-36RL	7451	168	93-21-20-36RL	5917	147	9-21-20-36RL	5705	147	50
<b>18" x 24"</b>	56"	18"	94-61-18-18RL	6585	160	93-61-18-18RL	5764	138	9-61-18-18RL	5278	138	29
	68"	24"	94-61-18-24RL	6783	179	93-61-18-24RL	5815	150	9-61-18-24RL	5387	150	43
	92"	36"	94-61-18-36RL	7631	210	93-61-18-36RL	6150	180	9-61-18-36RL	5948	180	67
<b>24" x 24"</b>	74"	24"	94-41-24-24RL	7615	213	93-41-24-24RL	6768	185	9-41-24-24RL	6283	185	48
	98"	36"	94-41-24-36RL	8918	252	93-41-24-36RL	7033	210	9-41-24-36RL	6571	210	64
<b>20" x 28"</b>	58"	18"	94-81-20-18RL	7539	173	93-81-20-18RL	6830	150	9-81-20-18RL	6357	150	46
	70"	24"	94-81-20-24RL	7745	186	93-81-20-24RL	7033	165	9-81-20-24RL	6565	165	55
	94"	36"	94-81-20-36RL	9746	225	93-81-20-36RL	7249	195	9-81-20-36RL	6733	195	73

Weights and Cubes are approximate



94 Series Shown

### ONE COMPARTMENT WITH ONE DRAINBOARD

#### Spec-Line 94 Series

#### Standard 93 Series

#### Super Saver 9 Series

14 Ga. 304 S/S 14" Water Level	16 Ga. 304 S/S 12" Water Level	18 Ga. 304 S/S 12" Water Level
-----------------------------------	-----------------------------------	-----------------------------------

Bowl Size	O.A. Length	DRBD. Size	Spec-Line 94 Series			Standard 93 Series			Super Saver 9 Series			Cu. Ft.
			Model #	Price	Approx. Wt. (lbs.)	Model #	Price	Approx. Wt. (lbs.)	Model #	Price	Approx. Wt. (lbs.)	
<b>16" x 20"</b>	40"	18"	94-1-24-18RorL	\$5579	93	93-1-24-18RorL	\$4816	84	9-1-24-18RorL	\$4518	65	20
	46"	24"	94-1-24-24RorL	5676	98	93-1-24-24RorL	4875	90	9-1-24-24RorL	4563	73	24
	58"	36"	94-1-24-36RorL	6186	114	93-1-24-36RorL	5388	101	9-1-24-36RorL	4969	78	26
<b>20" x 20"</b>	44"	18"	94-21-20-18RorL	6127	98	93-21-20-18RorL	5337	90	9-21-20-18RorL	4846	71	20
	50"	24"	94-21-20-24RorL	6222	104	93-21-20-24RorL	5378	96	9-21-20-24RorL	4896	77	23
	62"	36"	94-21-20-36RorL	6971	127	93-21-20-36RorL	5533	120	9-21-20-36RorL	5012	91	31
<b>18" x 24"</b>	42"	18"	94-61-18-18RorL	6343	100	93-61-18-18RorL	5581	94	9-61-18-18RorL	5108	75	24
	48"	24"	94-61-18-24RorL	6445	106	93-61-18-24RorL	5623	103	9-61-18-24RorL	5152	84	27
	60"	36"	94-61-18-36RorL	7172	130	93-61-18-36RorL	5770	122	9-61-18-36RorL	5262	95	38
<b>24" x 24"</b>	54"	24"	94-41-24-24RorL	7270	126	93-41-24-24RorL	6469	118	9-41-24-24RorL	5904	92	28
	66"	36"	94-41-24-36RorL	8395	149	93-41-24-36RorL	6613	141	9-41-24-36RorL	6059	110	42
<b>20" x 28"</b>	44"	18"	94-81-20-18RorL	7116	139	93-81-20-18RorL	6520	130	9-81-20-18RorL	5982	107	36
	50"	24"	94-81-20-24RorL	7237	146	93-81-20-24RorL	6645	137	9-81-20-24RorL	6097	113	46
	62"	36"	94-81-20-36RorL	9137	170	93-81-20-36RorL	6772	159	9-81-20-36RorL	6246	133	54

Weights and Cubes are approximate

See pages 35 and 36 for faucets, accessories, and modifications.

# REGALINE

## Deep Drawn Sinks



### TWO COMPARTMENTS WITH TWO DRAINBOARDS

#### Spec-Line 94 Series

#### Standard 93 Series

#### Super Saver 9 Series

14 Ga. 304 S/S 14" Water Level	16 Ga. 304 S/S 12" Water Level	18 Ga. 304 S/S 12" Water Level
-----------------------------------	-----------------------------------	-----------------------------------

Bowl Size	O.A. Length	DRBD. Size	Model #	Price	Approx. Wt. (lbs.)	Model #	Price	Approx. Wt. (lbs.)	Model #	Price	Approx. Wt. (lbs.)	Cu. Ft.
16" x 20"	72"	18"	94-2-36-18RL	\$7801	141	93-2-36-18RL	\$6621	118	9-2-36-18RL	\$6038	100	40
	85"	24"	94-2-36-24RL	7985	156	93-2-36-24RL	6742	130	9-2-36-24RL	6136	110	46
	109"	36"	94-2-36-36RL	8830	212	93-2-36-36RL	7619	169	9-2-36-36RL	6859	144	58
20" x 20"	81"	18"	94-22-40-18RL	8798	176	93-22-40-18RL	7484	147	9-22-40-18RL	6688	125	44
	93"	24"	94-22-40-24RL	8943	220	93-22-40-24RL	7569	184	9-22-40-24RL	6744	162	50
	117"	36"	94-22-40-36RL	9782	273	93-22-40-36RL	8031	237	9-22-40-36RL	7118	215	72
18" x 24"	77"	18"	94-62-36-18RL	8943	247	93-62-36-18RL	7671	206	9-62-36-18RL	6903	181	50
	89"	24"	94-62-36-24RL	9089	277	93-62-36-24RL	7750	241	9-62-36-24RL	6953	226	58
	113"	36"	94-62-36-36RL	9895	341	93-62-36-36RL	8191	297	9-62-36-36RL	7310	271	96
24" x 24"	101"	24"	94-42-48-24RL	10828	339	93-42-48-24RL	9581	295	9-42-48-24RL	8682	259	65
	125"	36"	94-42-48-36RL	11626	391	93-42-48-36RL	9921	339	9-42-48-36RL	9731	314	96
20" x 28"	81"	18"	94-82-40-18RL	10292	251	93-82-40-18RL	9999	219	9-82-40-18RL	9490	194	64
	93"	24"	94-82-40-24RL	10753	294	93-82-40-24RL	10216	253	9-82-40-24RL	9701	228	73
	117"	36"	94-82-40-36RL	11479	333	93-82-40-36RL	10419	287	9-82-40-36RL	9878	261	96

Weights and Cubes are approximate



### TWO COMPARTMENTS WITH ONE DRAINBOARD

#### Spec-Line 94 Series

#### Standard 93 Series

#### Super Saver 9 Series

14 Ga. 304 S/S 14" Water Level	16 Ga. 304 S/S 12" Water Level	18 Ga. 304 S/S 12" Water Level
-----------------------------------	-----------------------------------	-----------------------------------

Bowl Size	O.A. Length	DRBD. Size	Model #	Price	Approx. Wt. (lbs.)	Model #	Price	Approx. Wt. (lbs.)	Model #	Price	Approx. Wt. (lbs.)	Cu. Ft.
16" x 20"	58"	18"	94-2-36-18RorL	\$7539	108	93-2-36-18RorL	\$6375	88	9-2-36-18RorL	\$5845	72	26
	64"	24"	94-2-36-24RorL	7671	115	93-2-36-24RorL	6471	96	9-2-36-24RorL	5910	80	34
	76"	36"	94-2-36-36RorL	8066	158	93-2-36-36RorL	6589	132	9-2-36-36RorL	5998	115	42
20" x 20"	66"	18"	94-22-40-18RorL	8528	118	93-22-40-18RorL	7260	96	9-22-40-18RorL	6508	83	30
	72"	24"	94-22-40-24RorL	8627	136	93-22-40-24RorL	7296	114	9-22-40-24RorL	6536	95	39
	84"	36"	94-22-40-36RorL	9097	163	93-22-40-36RorL	7415	140	9-22-40-36RorL	6625	123	46
18" x 24"	62"	18"	94-62-36-18RorL	8682	147	93-62-36-18RorL	7444	128	9-62-36-18RorL	6729	115	40
	68"	24"	94-62-36-24RorL	8779	160	93-62-36-24RorL	7484	139	9-62-36-24RorL	6753	126	44
	80"	36"	94-62-36-36RorL	9237	200	93-62-36-36RorL	7599	174	9-62-36-36RorL	6837	158	53
24" x 24"	80"	24"	94-42-48-24RorL	10382	229	93-42-48-24RorL	9188	194	9-42-48-24RorL	8386	172	53
	92"	36"	94-42-48-36RorL	11013	261	93-42-48-36RorL	9889	235	9-42-48-36RorL	9427	194	60
20" x 28"	66"	18"	94-82-40-18RorL	10218	213	93-82-40-18RorL	9786	183	9-82-40-18RorL	9192	167	60
	72"	24"	94-82-40-24RorL	10339	227	93-82-40-24RorL	9907	195	9-82-40-24RorL	9310	176	64
	84"	36"	94-82-40-36RorL	10907	266	93-82-40-36RorL	10229	227	9-82-40-36RorL	9387	207	76

Weights and Cubes are approximate

See pages 35 and 36 for faucets, accessories, and modifications.



# REGALINE Deep Drawn Sinks



94 Series  
Shown

## THREE COMPARTMENTS WITH TWO DRAINBOARDS

### Spec-Line 94 Series

### Standard 93 Series

### Super Saver 9 Series

<b>14 Ga. 304 S/S</b> 14" Water Level	<b>16 Ga. 304 S/S</b> 12" Water Level	<b>18 Ga. 304 S/S</b> 12" Water Level
--	--	--

Bowl Size	O.A. Length	DRBD. Size	Model #	Price	Approx. Wt. (lbs.)	Model #	Price	Approx. Wt. (lbs.)	Model #	Price	Approx. Wt. (lbs.)	Cu. Ft.
<b>16" x 20"</b>	91"	18"	94-3-54-18RL	<b>\$9249</b>	230	93-3-54-18RL	<b>\$7923</b>	189	9-3-54-18RL	<b>\$6119</b>	182	49
	103"	24"	94-3-54-24RL	<b>9444</b>	248	93-3-54-24RL	<b>8042</b>	197	9-3-54-24RL	<b>6222</b>	190	55
	127"	36"	94-3-54-36RL	<b>10355</b>	275	93-3-54-36RL	<b>8535</b>	239	9-3-54-36RL	<b>8042</b>	208	96
<b>20" x 20"</b>	103"	18"	94-23-60-18RL	<b>10896</b>	248	93-23-60-18RL	<b>9395</b>	203	9-23-60-18RL	<b>8427</b>	198	59
	115"	24"	94-23-60-24RL	<b>11215</b>	276	93-23-60-24RL	<b>9639</b>	220	9-23-60-24RL	<b>8633</b>	195	65
	139"	36"	94-23-60-36RL	<b>12096</b>	408	93-23-60-36RL	<b>9988</b>	387	9-23-60-36RL	<b>8910</b>	364	89
<b>18" x 24"</b>	97"	18"	94-63-54-18RL	<b>10979</b>	323	93-63-54-18RL	<b>9522</b>	289	9-63-54-18RL	<b>8586</b>	226	62
	109"	24"	94-63-54-24RL	<b>11294</b>	334	93-63-54-24RL	<b>9753</b>	304	9-63-54-24RL	<b>8790</b>	233	85
	133"	36"	94-63-54-36RL	<b>12143</b>	418	93-63-54-36RL	<b>10099</b>	367	9-63-54-36RL	<b>9048</b>	325	96
<b>24" x 24"</b>	*127"	24"	94-43-72-24RL	<b>13382</b>	390	93-43-72-24RL	<b>12059</b>	331	9-43-72-24RL	<b>10936</b>	318	98
	*151"	36"	94-43-72-36RL	<b>14356</b>	448	93-43-72-36RL	<b>12324</b>	393	9-43-72-36RL	<b>11656</b>	345	110
<b>20" x 28"</b>	103"	18"	94-83-60-18RL	<b>13542</b>	358	93-83-60-18RL	<b>12113</b>	315	9-83-60-18RL	<b>11538</b>	277	83
	115"	24"	94-83-60-24RL	<b>13737</b>	394	93-83-60-24RL	<b>12320</b>	346	9-83-60-24RL	<b>11736</b>	305	95
	139"	36"	94-83-60-36RL	<b>14768</b>	451	93-83-60-36RL	<b>12614</b>	398	9-83-60-36RL	<b>11938</b>	350	109

\* Requires Two Faucets

Weights and Cubes are approximate



94 Series  
Shown

## THREE COMPARTMENTS WITH ONE DRAINBOARD

### Spec-Line 94 Series

### Standard 93 Series

### Super Saver 9 Series

<b>14 Ga. 304 S/S</b> 14" Water Level	<b>16 Ga. 304 S/S</b> 12" Water Level	<b>18 Ga. 304 S/S</b> 12" Water Level
--	--	--

Bowl Size	O.A. Length	DRBD. Size	Model #	Price	Approx. Wt. (lbs.)	Model #	Price	Approx. Wt. (lbs.)	Model #	Price	Approx. Wt. (lbs.)	Cu. Ft.
<b>16" x 20"</b>	77"	18"	94-3-54-18RorL	<b>\$9029</b>	214	93-3-54-18RorL	<b>\$7711</b>	173	9-3-54-18RorL	<b>\$5914</b>	167	42
	83"	24"	94-3-54-24RorL	<b>9123</b>	222	93-3-54-24RorL	<b>7770</b>	188	9-3-54-24RorL	<b>5971</b>	177	45
	95"	36"	94-3-54-36RorL	<b>9642</b>	243	93-3-54-36RorL	<b>8287</b>	220	9-3-54-36RorL	<b>7476</b>	190	51
<b>20" x 20"</b>	89"	18"	94-23-60-18RorL	<b>10650</b>	234	93-23-60-18RorL	<b>9145</b>	207	9-23-60-18RorL	<b>8224</b>	184	52
	95"	24"	94-23-60-24RorL	<b>10722</b>	245	93-23-60-24RorL	<b>9185</b>	205	9-23-60-24RorL	<b>8250</b>	193	55
	107"	36"	94-23-60-36RorL	<b>11327</b>	252	93-23-60-36RorL	<b>9485</b>	216	9-23-60-36RorL	<b>8347</b>	208	60
<b>18" x 24"</b>	83"	18"	94-63-54-18RorL	<b>10746</b>	296	93-63-54-18RorL	<b>9274</b>	271	9-63-54-18RorL	<b>8386</b>	255	54
	89"	24"	94-63-54-24RorL	<b>10817</b>	308	93-63-54-24RorL	<b>9310</b>	281	9-63-54-24RorL	<b>8415</b>	269	58
	101"	36"	94-63-54-36RorL	<b>11400</b>	318	93-63-54-36RorL	<b>9610</b>	300	9-63-54-36RorL	<b>8503</b>	287	65
<b>24" x 24"</b>	*107"	24"	94-43-72-24RorL	<b>13043</b>	342	93-43-72-24RorL	<b>11707</b>	312	9-43-72-24RorL	<b>10698</b>	298	68
	*119"	36"	94-43-72-36RorL	<b>14097</b>	365	93-43-72-36RorL	<b>11806</b>	339	9-43-72-36RorL	<b>11353</b>	320	96
<b>20" x 28"</b>	89"	18"	94-83-60-18RorL	<b>13159</b>	281	93-83-60-18RorL	<b>11813</b>	232	9-83-60-18RorL	<b>11292</b>	225	79
	95"	24"	94-83-60-24RorL	<b>13275</b>	296	93-83-60-24RorL	<b>11931</b>	273	9-83-60-24RorL	<b>11404</b>	268	86
	107"	36"	94-83-60-36RorL	<b>13736</b>	308	93-83-60-36RorL	<b>12042</b>	287	9-83-60-36RorL	<b>11474</b>	277	89

\* Requires Two Faucets

Weights and Cubes are approximate

See pages 35 and 36 for faucets, accessories, and modifications.

# REGALINE

## Deep Drawn Sinks



### FOUR COMPARTMENTS WITH TWO DRAINBOARDS

Bowl Size	O.A. Length	DRBD. Size	Spec-Line 94 Series			Standard 93 Series			Super Saver 9 Series			Cu. Ft.
			Model #	Price	Approx. Wt. (lbs.)	Model #	Price	Approx. Wt. (lbs.)	Model #	Price	Approx. Wt. (lbs.)	
16" x 20"	110"	18"	94-4-72-18RL	\$11581	210	93-4-72-18RL	\$9980	183	9-4-72-18RL	\$9258	175	58
	122"	24"	94-4-72-24RL	11796	275	93-4-72-24RL	10131	252	9-4-72-24RL	9383	241	64
	146"	36"	94-4-72-36RL	12659	313	93-4-72-36RL	10440	287	9-4-72-36RL	9936	274	86
20" x 20"	126"	18"	94-24-80-18RL	13510	293	93-24-80-18RL	11626	268	9-24-80-18RL	10440	259	87
	138"	24"	94-24-80-24RL	13647	312	93-24-80-24RL	11776	286	9-24-80-24RL	10533	275	95
	162"	36"	94-24-80-36RL	14627	351	93-24-80-36RL	12101	322	9-24-80-36RL	11079	308	111
18" x 24"	118"	18"	94-64-72-18RL	13517	358	93-64-72-18RL	11692	346	9-64-72-18RL	10536	336	82
	130"	24"	94-64-72-24RL	13648	372	93-64-72-24RL	11832	355	9-64-72-24RL	10634	344	90
	154"	36"	94-64-72-36RL	14597	409	93-64-72-36RL	12146	392	9-64-72-36RL	11162	378	106
24" x 24"	154"	24"	94-44-96-24RL	16125	395	93-44-96-24RL	15187	361	9-44-96-24RL	13449	348	106
	178"	36"	94-44-96-36RL	17283	431	93-44-96-36RL	15534	398	9-44-96-36RL	14622	382	122
20" x 28"	126"	18"	94-84-80-18RL	16389	382	93-84-80-18RL	15514	361	9-84-80-18RL	14647	350	97
	138"	24"	94-84-80-24RL	16598	402	93-84-80-24RL	15722	374	9-84-80-24RL	14852	361	106
	162"	36"	94-84-80-36RL	17832	442	93-84-80-36RL	16029	411	9-84-80-36RL	15027	395	124

ALL UNITS REQUIRE TWO FAUCETS

Weights and Cubes are approximate

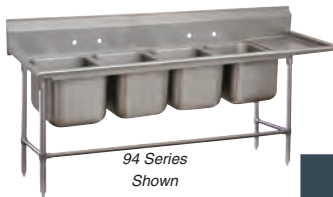

### FOUR COMPARTMENTS WITH ONE DRAINBOARD

Bowl Size	O.A. Length	DRBD. Size	Spec-Line 94 Series			Standard 93 Series			Super Saver 9 Series			Cu. Ft.
			Model #	Price	Approx. Wt. (lbs.)	Model #	Price	Approx. Wt. (lbs.)	Model #	Price	Approx. Wt. (lbs.)	
16" x 20"	95"	18"	94-4-72-18RorL	\$11166	202	93-4-72-18RorL	\$9585	165	9-4-72-18RorL	\$8911	158	52
	101"	24"	94-4-72-24RorL	11266	216	93-4-72-24RorL	9649	186	9-4-72-24RorL	8952	175	54
	113"	36"	94-4-72-36RorL	12065	260	93-4-72-36RorL	9951	238	9-4-72-36RorL	9519	227	60
20" x 20"	111"	18"	94-24-80-18RorL	13186	299	93-24-80-18RorL	11395	241	9-24-80-18RorL	9477	229	61
	117"	24"	94-24-80-24RorL	13258	320	93-24-80-24RorL	11433	250	9-24-80-24RorL	10292	239	82
	129"	36"	94-24-80-36RorL	14043	341	93-24-80-36RorL	11589	267	9-24-80-36RorL	10418	250	90
18" x 24"	103"	18"	94-64-72-18RorL	13202	339	93-64-72-18RorL	11465	329	9-64-72-18RorL	9778	318	72
	109"	24"	94-64-72-24RorL	13275	351	93-64-72-24RorL	11507	338	9-64-72-24RorL	10396	329	76
	121"	36"	94-64-72-36RorL	14036	369	93-64-72-36RorL	11660	353	9-64-72-36RorL	10511	341	84
24" x 24"	133"	24"	94-44-96-24RorL	15682	354	93-44-96-24RorL	14858	336	9-44-96-24RorL	13160	327	92
	145"	36"	94-44-96-36RorL	16215	376	93-44-96-36RorL	15041	355	9-44-96-36RorL	14178	344	100
20" x 28"	111"	18"	94-84-80-18RorL	16009	348	93-84-80-18RorL	15211	329	9-84-80-18RorL	14356	317	87
	117"	24"	94-84-80-24RorL	16127	364	93-84-80-24RorL	15326	337	9-84-80-24RorL	14478	329	91
	129"	36"	94-84-80-36RorL	17156	382	93-84-80-36RorL	15447	355	9-84-80-36RorL	14539	347	100

ALL UNITS REQUIRE TWO FAUCETS

Weights and Cubes are approximate

See pages 35 and 36 for faucets, accessories, and modifications.



# SPECIALTY SINKS

## Specialty Sinks

### Corner Sinks

16 Gauge, 304 Stainless Steel

- Adjustable Cross-Bracing
- Stainless Steel Legs
- Stainless Steel Adjustable Bullet Feet



**REQUIRES TWO FAUCETS**

94-K3-11D Shown

**MINI CORNER**

OPTIONAL:

5/8" Thick Poly-Vance Cutting Boards Available  
(See Grid For Proper Model)

### Six Deep Drawn Combinations To Choose From!

Model #	Bowl Sizes	Wall Dim.	Drbd. Dim.	Price	Approx. Wt.	Approx. Cubes	Optional Poly-Vance Cutting Boards
94-K6-18D	1) 20" x 20" x 12" 2) 16" x 20" x 12"	61" x 61"	18"	<b>\$10625</b>	231 lbs.	71	K-2E <b>\$413</b>
94-K2-24D	3) 20" x 20" x 12"	71" x 71"	24"	<b>10905</b>	265 lbs.	99	K-2E <b>413</b>
94-K4-24D	3) 24" x 24" x 12"	79" x 79"	24"	<b>11630</b>	338 lbs.	114	K-2F <b>413</b>
94-K8-30D	1) 20" x 20" x 12" 2) 20" x 28" x 12"	86" x 86"	30"	<b>12382</b>	350 lbs.	131	K-2E <b>413</b>
94-K3-11D	1) 14" x 14" x 12" 2) 14" x 16" x 12"	54" x 54"	17"	<b>7281</b>	215 lbs.	60	K-2H <b>413</b>
94-K5-11D	1) 14" x 14" x 10" 2) 10" x 14" x 10"	42" x 42"	11"	<b>7888</b>	180 lbs.	37	K-2H <b>413</b>

## FABRICATED SPECIALTY SINKS

### Convenience Store Sinks

**Our Solution....to Your Limited Space Problem**  
**In Six Feet or less... you can WASH, RINSE & SANITIZE**

- 18 Gauge Stainless Steel
- Stainless Steel Legs
- Welded Cross Bracing
- Stainless Steel Adjustable Bullet Feet

All Sinks Feature  
**TWO Drainboards**



Model #	Bowl Size	# of Comp.	Drbd. Size	O.A. Length	Price	Approx. Wt.	Approx. Cu.
K7-CS-21	10" x 14" x 10"	3	12"	58"	<b>\$3891</b>	85 lbs.	27
K7-CS-22	10" x 14" x 10"	3	18"	70"	<b>4000</b>	120 lbs.	39
K7-CS-29	14" x 16" x 12"	3	12"	70"	<b>4261</b>	138 lbs.	39
K7-CS-32	12" x 20" x 12"	3	12"	64"	<b>4946</b>	130 lbs.	35

### Super Size Sinks 16 Gauge, 304 Stainless Steel

Model #	Bowl Size	# of Comp.	Drbd. Size	Overall Size L x W	Price	Approx. Wt.	Approx. Cu.
K7-3-1432-18RL*	14" x 32" x 12"	3	18"	78" x 36"	<b>\$10359</b>	290 lbs.	50
K7-3-2030-24RL	20" x 30" x 14"	3	24"	108" x 36"	<b>14832</b>	345 lbs.	78
K7-3-2430-24RL	24" x 30" x 14"	3	24"	120" x 36"	<b>15420</b>	380 lbs.	86
K7-3-3024-24RL	30" x 24" x 14"	3	24"	138" x 30"	<b>15961</b>	395 lbs.	84
K7-3-3030-24RL	30" x 30" x 14"	3	24"	138" x 36"	<b>16717</b>	420 lbs.	98

\*12" Deep Bowls For 14 Gauge Units Add -14 At End Of Model Number & Add \$741 List.



- Fabricated Design
- 16 ga. 304 Series
- 14" Deep Bowls
- Tile Edge Splash
- Full Skirt Design
- Stainless Steel Legs
- Stainless Steel Adjustable Bullet Feet
- Space Saving - Reduced Overall Lengths

### Meat & Platter Sink

16 Gauge, 304 Stainless Steel

- Two 18" Drainboards
- 91" x 35 1/2"

**Bowl Sizes:**

- 1 - 24" x 30" Bowl
- 2 - 15" x 32" Bowls

• 351 lbs. 59 Cu. Ft.



18-K5-56 **\$15661**

### Heavy Duty Extra Long Faucet

**Required Faucet For Meat & Platter Sink**



- Splash Mount
- 18" Swing Spout
- 8" O.C.
- T&S Equivalent: 5f-8WLX18

**K-211 \$784**

Units Can Be Customized With Modifications & Accessories!  
See Pages 35 & 36. Other Sizes Available. Call For Pricing.

# FABRICATED

## FC Series Fabricated Sinks

**SUPER STURDY**  
CROSS BRACING

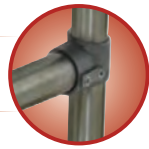

### 16 GAUGE FABRICATED SINKS

- 16 Ga. 304 Stainless Steel
- 14" Deep Bowls
- All Welded Super-Sturdy Cross-Bracing
- Tile Edge Splash
- Stainless Steel Legs
- Adjustable Stainless Steel Bullet Feet



#### ONE COMPARTMENT SINKS

Bowl Size	Model #	O.A. Length	O.A. Width	Price	Wt.	Cu.
16" x 20"	FC-1-1620	21"	26"	\$2082	49	12
	FC-1-1620-18RorL	36.5"	26"	2779	65	18
	FC-1-1620-18RL	52"	26"	2869	80	25
18" x 18"	FC-1-1818	23"	24"	2035	50	13
	FC-1-1818-18RorL	38.5"	24"	2698	60	22
	FC-1-1818-18RL	54"	24"	2748	72	24
	FC-1-1818-24RorL	45"	24"	3088	66	17
	FC-1-1818-24RL	66"	24"	3191	85	26
18" x 24"	FC-1-1824	23"	30"	2364	63	16
	FC-1-1824-18RorL	38.5"	30"	2990	130	25
	FC-1-1824-24RorL	45"	30"	3146	139	28
	FC-1-1824-18RL	54"	30"	3089	170	34
	FC-1-1824-24RL	66"	30"	3203	175	40
24" x 24"	FC-1-2424	29"	30"	2514	68	16
	FC-1-2424-18RorL	44.5"	30"	3179	95	28
	FC-1-2424-24RorL	50.5"	30"	3445	146	34
	FC-1-2424-18RL	60"	30"	3374	175	37
	FC-1-2424-24RL	72"	30"	3556	196	44
30" x 24"	FC-1-3024	35"	30"	4608	80	20
	FC-1-3024-24RorL	56.5"	30"	4991	180	41
	FC-1-3024-24RL	78"	30"	5462	225	50
36" x 24"	FC-1-3624	41"	30"	5462	200	26
	FC-1-3624-24RorL	62.5"	30"	5695	225	46
	FC-1-3624-24RL	84"	30"	7792	250	59
48" x 24"	FC-1-4824-24RL	96"	30"	8206	290	56

#### TWO COMPARTMENT SINKS

Bowl Size	Model #	O.A. Length	O.A. Width	Price	Wt.	Cu.
15" x 15"	FC-2-1515	35"	21"	\$3235	57	19
	FC-2-1620	37"	26"	3724	60	18
16" x 20"	FC-2-1620-18RorL	52.5"	26"	4362	62	25
	FC-2-1620-18RL	68"	26"	4485	101	32
	FC-2-1818	41"	24"	3504	66	23
18" x 18"	FC-2-1818-18RorL	56.5"	24"	4056	89	26
	FC-2-1818-18RL	72"	24"	4294	183	41
	FC-2-1818-24RL	84"	24"	4612	200	30
	FC-2-1824	41"	30"	3765	181	26
18" x 24"	FC-2-1824-18RorL	56.5"	30"	4278	185	37
	FC-2-1824-24RorL	62.5"	30"	4677	200	39
	FC-2-1824-18RL	72"	30"	4808	210	44
	FC-2-1824-24RL	84"	30"	5025	230	51
20" x 30"	FC-2-2030-18RorL	60.5"	30"	7097	195	42
	FC-2-2030-18RL	76"	30"	7245	250	47
	FC-2-2030-24RorL	66.5"	30"	7434	250	45
	FC-2-2030-24RL	88"	30"	7604	285	56
24" x 24"	FC-2-2424	53"	30"	4105	181	33
	FC-2-2424-18RorL	68.5"	30"	5031	233	42
	FC-2-2424-24RorL	74.5"	30"	5220	240	46
	FC-2-2424-18RL	84"	30"	5119	245	53
	FC-2-2424-24RL	96"	30"	5352	255	60

Additional Sizes Available.

See Modifications & Accessories on Pages 35 & 36

#### Fabricated Corner Sink

16 Gauge, 304 Stainless Steel

FC-K6-18D \$7655



- Welded Cross-Bracing
- S/S Legs & Bullet Feet
- Requires 2 Faucets (Not Included)
- 3 - 18" x 18" x 14" Bowls
- 2 - 18" x 18" Drainboards
- Wall Dimension: 57" x 57"
- 248 Lbs. 66 Cu. Ft.





**SUPER STURDY**  
CROSS BRACING



# FABRICATED

## FC Series Fabricated Sinks

### 16 GAUGE FABRICATED SINKS



- 16 Ga. 304 Stainless Steel
- 14" Deep Bowls
- All Welded Super-Sturdy Cross-Bracing
- Tile Edge Splash
- Stainless Steel Legs
- Adjustable Stainless Steel Bullet Feet

### THREE COMPARTMENT SINKS

Bowl Size	Model #	O.A. Length	O.A. Width	Price	Wt.	Cu.
15" x 15"	FC-3-1515	50"	21"	\$3697	85	25
	FC-3-1515-15RorL	62.5"	21"	3966	98	31
	FC-3-1515-15RL	75"	21"	4074	120	42
15" x 24"	FC-3-1524	50"	30"	4805	180	34
	FC-3-1524-24RorL	71.5"	30"	4928	210	58
	FC-3-1524-24RL	93"	30"	5174	255	52
16" x 20"	FC-3-1620	53"	26"	4089	120	25
	FC-3-1620-18RorL	68.5"	26"	4370	225	32
	FC-3-1620-18RL	84"	26"	4613	235	38
	FC-3-1620-24RL	96"	26"	4938	263	49
18" x 18"	FC-3-1818	59"	24"	3941	135	25
	FC-3-1818-18RorL	74.5"	24"	4190	235	31
	FC-3-1818-24RorL	80.5"	24"	4324	250	34
	FC-3-1818-18RL	90"	24"	4733	245	47
18" x 24"	FC-3-1824	59"	30"	4213	182	36
	FC-3-1824-18RorL	74.5"	30"	4743	220	61
	FC-3-1824-24RorL	80.5"	30"	4946	230	49
	FC-3-1824-18RL	90"	30"	5310	265	56
24" x 24"	FC-3-2424	79"	30"	4895	243	47
	†FC-3-2424-18RorL	92.5"	30"	5800	260	56
	†FC-3-2424-24RorL	98.5"	30"	6047	281	67
	†FC-3-2424-18RL	108"	30"	5990	295	64
20" x 28"	†FC-3-2424-24RL	120"	30"	6172	315	68
	FC-3-2028-24RL	108"	34"	7158	310	62
20" x 30"	FC-3-2030-20RL	100"	36"	6530	318	58
	FC-3-2030-24RL	108"	36"	7247	330	64
	FC-3-2030-30RL	150"	36"	7702	345	70
24" x 30"	†FC-3-2430	77"	36"	5297	225	38
	†FC-3-2430-24RorL	99"	36"	6164	310	59
	†FC-3-2430-24RL	120"	36"	9138	345	81
	†FC-3-2430-30RorL	105"	36"	8088	335	62
	†FC-3-2430-30RL	132"	36"	9414	370	86
	†FC-3-2430-36RorL	111"	36"	8389	360	66
	†FC-3-2430-36RL	144"	36"	9539	410	93

† Requires Two Sets of Faucets

Bowl Size	Model #	O.A. Length	O.A. Width	Price	Wt.	Cu.
30" x 24"	†FC-3-3024	95"	30"	\$6169	225	38
	†FC-3-3024-24RorL	117"	30"	8059	325	59
	†FC-3-3024-24RL	138"	30"	9244	360	81
	†FC-3-3024-30RorL	123"	30"	8446	350	62
	†FC-3-3024-30RL	150"	30"	9566	395	86
	†FC-3-3024-36RorL	129"	30"	8620	390	66
30" x 30"	†FC-3-3024-36RL	162"	30"	9904	425	93
	†FC-3-3030	95"	36"	8447	250	43
	†FC-3-3030-24RL	138"	36"	14293	390	96
	†FC-3-3030-30RL	150"	36"	14946	435	104
	†FC-3-3030-36RL	162"	36"	15110	460	112

† Requires Two Sets of Faucets

### FOUR COMPARTMENT SINKS

Bowl Size	Model #	O.A. Length	O.A. Width	Price	Wt.	Cu.
18" x 18"	FC-4-1818-18RL†	108"	24"	\$6796	280	51
18" x 24"	FC-4-1824-18RL†	108"	30"	7568	340	62
24" x 24"	FC-4-2424-24RL†	144"	30"	9240	355	80

† Requires Two Sets of Faucets

### Tubular KD Wall Mounted Drainage Shelves

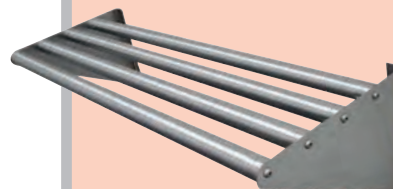

- Stainless Steel
- 15" Deep
- 1-5/8" Diameter Stainless Steel Tubing

Model #	Size	Price
DT-6R-36	3"	\$1447
DT-6R-48	4"	1674
DT-6R-60	5"	1880
DT-6R-72	6"	2060

# FABRICATED

## Fabricated Sinks



**SUPER STURDY**  
CROSS BRACING



# SPEC-LINE

## 14 GAUGE FABRICATED SINKS

- 14 Ga. 304 Stainless Steel
- 14" Deep Bowls
- Tile Edge Splash
- Continuous Apron Design
- All Welded Super-Sturdy Cross-Bracing
- Stainless Steel Legs & Adjustable Stainless Steel Bullet Feet

### Features and Benefits

- 3/4" Radius Corners
- Economical Savings
- Satin Finish



### ONE COMPARTMENT SINKS

Bowl Size	Model #	O.A. Length	O.A. Width	Price	Wt.	Cu.
16" x 20"	FS-1-1620	21"	26"	\$3322	60	12
	FS-1-1620-18RorL	36.5	26"	3570	80	20
	FS-1-1620-18RL	52"	26"	3879	100	27
18" x 18"	FS-1-1818	23"	24"	3388	60	11
	FS-1-1818-18RorL	38.5	24"	3809	75	17
18" x 24"	FS-1-1824	23"	30"	3683	78	16
	FS-1-1824-18RorL	38.5	30"	4216	92	25
	FS-1-1824-24RorL	44.5	30"	4423	105	28
	FS-1-1824-18RL	54"	30"	4527	175	34
24" x 24"	FS-1-1824-24RL	66"	30"	4725	198	40
	FS-1-2424	29"	30"	4234	90	19
	FS-1-2424-18RorL	44.5	30"	4761	110	28
	FS-1-2424-24RorL	50.5	30"	4816	119	34
30" x 24"	FS-1-2424-18RL	60"	30"	4915	185	37
	FS-1-2424-24RL	72"	30"	5928	209	44
	FS-1-3024	35"	30"	4868	115	23
36" x 24"	FS-1-3024-24RorL	56.5	30"	5711	190	35
	FS-1-3024-24RL	78"	30"	6138	240	47
	FS-1-3624	41"	30"	5504	140	26
48" x 24"	FS-1-3624-24RorL	62.5	30"	6351	210	39
	FS-1-3624-24RL	84"	30"	8256	260	51
	FS-1-4824-24RL	96"	30"	8658	315	59

### TWO COMPARTMENT SINKS

Bowl Size	Model #	O.A. Length	O.A. Width	Price	Wt.	Cu.
16" x 20"	FS-2-1620	37"	26"	\$4775	100	20
	FS-2-1620-18RorL	52.5	26"	5187	120	27
	FS-2-1620-18RL	68"	26"	5315	143	34
18" x 18"	FS-2-1818	41"	24"	4868	98	18
	FS-2-1818-18RorL	56.5	24"	5238	110	26
18" x 24"	FS-2-1818-18RL	72"	24"	5504	125	30
	FS-2-1824	41"	30"	5123	149	26
	FS-2-1824-18RorL	56.5	30"	5649	169	35
	FS-2-1824-24RorL	62.5	30"	6283	190	39
24" x 24"	FS-2-1824-18RL	72"	30"	6457	220	44
	FS-2-1824-24RL	84"	30"	7475	240	51
	FS-2-2424	53"	30"	5641	179	33
	FS-2-2424-18RorL	68.5	30"	6909	200	42
20" x 30"	FS-2-2424-24RorL	74.5	30"	7077	220	48
	FS-2-2424-18RL	84"	30"	7449	245	53
	FS-2-2424-24RL	96"	30"	7982	270	60
30" x 24"	FS-2-2030-18RorL	60.5	36"	7150	250	45
	FS-2-2030-18RL	76"	36"	7427	260	54
	FS-2-2030-24RorL	66.5	36"	7668	255	48
	FS-2-2030-24RL	88"	36"	7878	270	61
	FS-2-3024	65"	30"	6985	265	40
	FS-2-3024-24RorL	86.5	30"	8256	300	52
	FS-2-3024-24RL	108"	30"	8679	320	64

Additional Sizes Available.

See Modifications & Accessories on Pages 35 & 36

**SUPER STURDY**  
CROSS BRACING

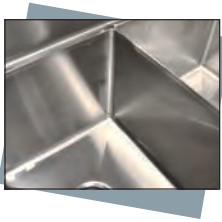

Fabricated Bowls are  
Welded Together at the  
Seams & Polished



## THREE COMPARTMENT SINKS

Bowl Size	Model #	O.A. Length	O.A. Width	Price	Wt.	Cu.
16" x 20"	FS-3-1620	53"	26"	<b>\$6706</b>	140	27
	FS-3-1620-18RorL	68.5"	26"	<b>7462</b>	160	35
	FS-3-1620-18RL	84"	26"	<b>8191</b>	155	36
	FS-3-1620-24RL	96"	26"	<b>8809</b>	235	47
	FS-3-1620-36RL	120"	26"	<b>9117</b>	280	59
18" x 18"	FS-3-1818	59"	24"	<b>6985</b>	130	25
	FS-3-1818-18RorL	75"	24"	<b>7622</b>	150	31
	FS-3-1818-18RL	90"	24"	<b>8469</b>	170	52
18" x 24"	FS-3-1824	59"	30"	<b>7239</b>	158	36
	FS-3-1824-18RorL	74.5"	30"	<b>8131</b>	174	46
	FS-3-1824-24RorL	80.5"	30"	<b>8382</b>	187	49
	FS-3-1824-18RL	90"	30"	<b>9295</b>	310	54
	FS-3-1824-24RL	102"	30"	<b>9947</b>	375	61
24" x 24"	FS-3-2424†	77"	30"	<b>8149</b>	329	47
	FS-3-2424-18RorL†	92.5"	30"	<b>9089</b>	353	56
	FS-3-2424-24RorL†	98.5"	30"	<b>9313</b>	369	59
	FS-3-2424-18RL†	108"	30"	<b>10266</b>	382	64
	FS-3-2424-24RL†	120"	30"	<b>10476</b>	405	71

† Requires Two Sets of Faucets

# FABRICATED

## Fabricated Sinks

# SPEC-LINE

## 14 GAUGE FABRICATED SINKS

- 14 Ga. 304 Stainless Steel
- 14" Deep Bowls
- Tile Edge Splash
- Continuous Apron Design
- All Welded Super-Sturdy Cross-Bracing
- Stainless Steel Legs & Adjustable Stainless Steel Bullet Feet

### FC & FS Series Accessories

Optional Front Cross  
Bracing For FS Sinks  
FC-CB-1 \$57 per foot



Stainless Steel Leg  
With Bullet Foot  
K-475 \$100 per leg

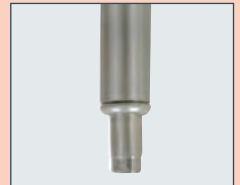

Stainless Steel  
Sink Covers

See Page 35

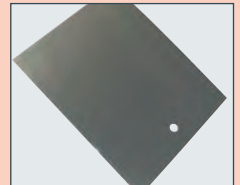

Removable 12"  
Side Splashes For  
FC & FS Series Sinks

Accommodates Left & right Sides



Model #	Price	Description
K-700	<b>\$638</b>	For FC & FS Series Sink Bowls: 10"x14", 14"x16", 15"x15", 16"x20"
K-700F-18	<b>670</b>	FC & FS Sink Bowls: 18"x18" Sink Bowls
K-700F-24	<b>704</b>	For FC & FS Series Sink Bowls: 15"x24", 18"x24", 24"x24" & 30"x24"
K-700F-30	<b>778</b>	For FC & FS Series Sink Bowls: 20"x30", 24"x30", 30"x30"

### Popular Sink Faucets

8" Swing Spout Faucet  
8" O.C.  
K-1118 **\$630**



12" Swing Spout Faucet  
8" O.C.  
K-112 **\$674**



14" Swing Spout Faucet  
8" O.C.  
K-105 **\$704**



See Page 36 for Additional Faucets

# BUDGET SINKS

## Budget Line Scullery Sinks

 = Ship Via UPS

For Residential Finish & Packaging, Add K-350 \$457



4-1-24 Shown

- 18" & 21" Wide Sink Bowls Are 14" Deep
- 24" Wide Sink Bowls Are 13" Deep
- 3-1/2" Basket Drain
- 8" O.C. Faucet Holes On Splash

	Bowl Size	L	Wt.	Cu. Ft.	"400" Series (430 S/S)		"600" Series (300 S/S)	
					Model #	Price	Model #	Price
1 COMP.	18" x 18"	18"	44 lbs.	8	4-81-18	\$1510	6-81-18	\$1734
	21" x 18"	18"	47 lbs.	9	4-1-18	1537	N/A	-
	21" x 24"	24"	53 lbs.	12	4-1-24	1564	6-1-24	1959
	21" x 36"	36"	66 lbs.	16	4-1-36	1789	6-1-36	2014
	24" x 24"	24"	54 lbs.	12	4-41-24	1899	6-41-24	2099
2 COMP.	24" x 36"	36"	69 lbs.	17	4-41-36	2032	6-41-36	2240
	21" x 36"	36"	73 lbs.	16	4-2-36	2210	6-2-36	2490
	21" x 48"	48"	86 lbs.	21	4-2-48	2407	6-2-48	2739
	21" x 60"	60"	98 lbs.	26	4-2-60	3050	N/A	-
	24" x 48"	48"	88 lbs.	22	4-42-48	2659	6-42-48	2937
3 COMP.	24" x 60"	60"	108 lbs.	27	4-42-60	3221	N/A	-
	21" x 36"	36"	78 lbs.	16	4-3-36	2378	6-3-36	2659
	21" x 48"	48"	91 lbs.	21	4-3-48	2578	6-3-48	3050
	21" x 54"	54"	98 lbs.	24	4-3-54	2684	6-3-54	3133

## 3-1/2" Rear Deck Budget Sinks



4-1-24D Shown

- 14" Deep Bowls
- 4" Back Splash
- 3-1/2" Basket Drain
- 8" O.C. Faucet Holes On Deck



4-41-48D Shown

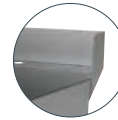

4" Back Splash

Bowl Size	L	Wt.	Cu. Ft.	"400" Series (430 S/S)		"600" Series (300 S/S)	
				Model #	Price	Model #	Price
21" x 18"	18"	47 lbs.	9	4-1-18D	\$1683	N/A	-
21" x 24"	24"	53 lbs.	12	4-1-24D	1729	6-1-24D	2075
24" x 24"	24"	54 lbs.	12	4-41-24D	2023	6-41-24D	2429
24" x 36"	36"	66 lbs.	17	4-41-36D	2115	6-41-36D	2538
24" x 48"	48"	79 lbs.	17	4-41-48D	2926	6-41-48D	3512

## Heavy Duty Deck Mounted Service Faucets

Model #	Spout	Price
K-127	8"	\$630
K-128	12"	674
K-129	14"	704



## Drainboards

Model #	Size	Approx. Wt.	Approx. Cu. Ft.	Price
N-5-818	18" x 18"	13 lbs.	1	\$572
N-5-18	21" x 18"	15 lbs.	1	615
N-5-24	21" x 24"	18 lbs.	1	712
N-5-30	21" x 30"	22 lbs.	2	803
N-5-36	21" x 36"	25 lbs.	2	1286
N-5-48	21" x 48"	28 lbs.	3	1538
N-54-24	24" x 24"	20 lbs.	1	766
N-54-36	24" x 36"	25 lbs.	2	1353
N-54-48	24" x 48"	30 lbs.	3	1602

- Drainboards 36" & Larger Supplied With Legs
- Sides & End Of Drainboard Turned Up with 2" Hemmed Edges Along Top

## Stainless Steel Sink Covers For One Compartment Budget Sinks

Model #	Size	Price
LSC-81	18" x 18"	\$640
LSC-24	21" x 24"	640
LSC-242	24" x 24"	640
LSC-36	24" x 36"	640



Stores Conveniently On Side Of Sink

## MOBILE & SILVER SOAK SINKS



### Mobile Sinks

34" Working Height

A Multi-Purpose Unit.

Move it where the ACTION is! A must for the large food preparation type installation.

Model #	Bowl Size	Price	Approx. Wt.
9-FMS-20	22" x 22" x 8"	\$5881	50 lbs.
9-FMS-12	22" x 22" x 12"	6444	50 lbs.

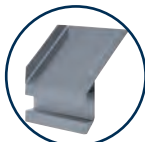

Optional Chute  
9-SS-1 \$678



Optional Bumpers  
9-SS-2 \$319

### Silver Soak Sinks

20" Working Height

UNIVERSAL BOWL SIZE.

Accommodates 19 3/4" x 19 3/4" Dishwasher Baskets

Model #	Bowl Size	Price	Approx. Wt.
9-FSS-20	22" x 22" x 8"	\$5619	42 lbs.



### Silver Soak Sinks with Detachable Chute

20" Working Height

Required for the Scullery operation that promotes clean sanitary flatware.

Model #	Bowl Size	Price	Approx. Wt.
9-FSC-20	22" x 22" x 8"	\$6161	50 lbs.

Shown with  
Optional Bumpers



# SINK MODS

## Sink Modifications & Accessories

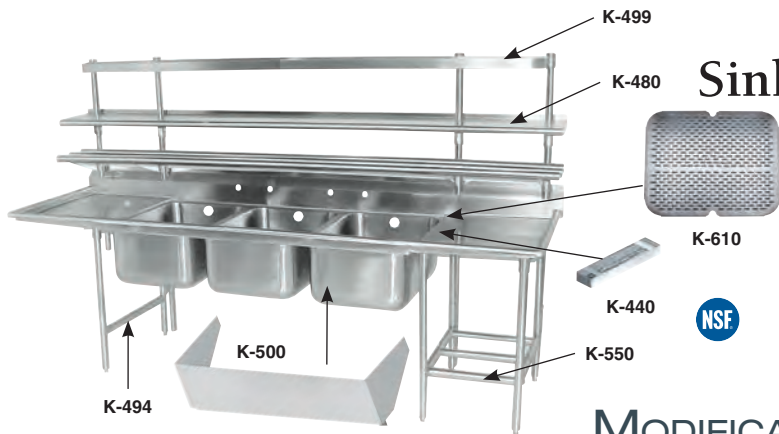

**K-37**  
Anti-Siphon Vacuum  
Breaker Holes



**K-72**  
Leg-To-Wall  
Brace



**K-460A**  
Disposal Cone w/  
Control Bracket &  
Faucet Holes



**K-461A**  
Install Collar  
w/ Control Bracket

## MODIFICATIONS

<b>K-4</b>	Support Bracket for Lever Waste Drain Handle	<b>\$189 ea.</b>
<b>K-23</b>	Sink Legs Welded To Undershelf Or Left-To-Right Cross Rails, Shipped Set Up & Crated. (Top Is Not Welded To Legs)	<b>561 per sink</b>
<b>K-23A</b>	Sink Legs Welded To Leg Gussets Under Sink Top & To Undershelf Or Left-To-Right Cross Rails, Shipped Set Up & Crated	<b>741 per sink</b>
<b>K-24</b>	Shell Crating	<b>433</b>
<b>K-37</b>	Anti-Siphon Vacuum Breaker Holes	<b>168</b>
<b>K-57</b>	Welded field joint (Welded in field by others)	<b>391 per sink</b>
<b>K-76</b>	Paint on Sound Deadening	<b>746</b>
<b>K-77</b>	Splash Cutout (Pipe Chase)	<b>265</b>
<b>K-106</b>	Mirror Highlite Edge for Sink	<b>608</b>
<b>K-440</b>	Waste Trough with 2" deep removable basket	<b>1277</b>
<b>K-447</b>	High Backsplash up to 18"	<b>265 lin. ft.</b>
<b>K-448</b>	High Backsplash up to 13"	<b>212 lin. ft.</b>
<b>K-450</b>	Extend Drainboard Length (Drainboards over 36" Are Not Crated or Pitched.)	<b>537 lin. ft.</b>
<b>K-451</b>	Drainboard Corner Turn	<b>1876 ea.</b>
<b>K-452</b>	Control Bracket 8" x 12"	<b>373 ea.</b>
<b>K-452S</b>	Splash Mounted Control Bracket 8" x 12"	<b>422 ea.</b>
<b>K-453</b>	Control Bracket 14" x 16"	<b>400 ea.</b>
<b>K-453S</b>	Splash Mounted Control Bracket 14" x 16"	<b>466 ea.</b>
<b>K-454</b>	Sidesplash	<b>581 ea.</b>
<b>K-456</b>	Scrap Block Installed	<b>546</b>
<b>K-460</b>	Installation of Disposal Cone with 8" x 12" Control Bracket, Faucet Holes (Cone supplied by others)	<b>1115 ea.</b>

<b>K-460A</b>	Installation of Disposal Cone with 14" x 16" Control Bracket, Faucet Holes (Cone supplied by others)	<b>\$1184 ea.</b>
<b>K-461</b>	Install Collar with 8" x 12" control bracket (Collar by others)	<b>1115</b>
<b>K-461A</b>	Install Collar with 14" x 16" control bracket (Collar by others)	<b>1184</b>
<b>K-470</b>	Modify Bowl Depth	<b>242 ea.</b>
<b>K-472</b>	Faucet Hole Revision	<b>176 ea</b>
<b>K-473</b>	Working Height Revision	<b>141 ea</b>
<b>K-476</b>	Punch for Over Flow Holes (Holes Only. N/C when ordering K-15)	<b>79 ea.</b>
<b>K-479</b>	Undershelf Under Drainboard	<b>337 lin. ft.</b>
<b>K-480</b>	Stainless Steel 12" Wide Shelf (min. of 3 ft.)	<b>350 lin. ft.</b>
<b>K-480A</b>	Stainless Steel 15" Wide Shelf (min. of 3 ft.)	<b>503 lin. ft.</b>
<b>K-490</b>	Provision for Pot Washer (For "Wells-PW-106" only)	<b>1406 ea.</b>
<b>K-491</b>	Provision for Hatco Heater	<b>266 ea.</b>
<b>K-495</b>	Turn Down Backsplash (Includes 2 Brackets. See K-397 Add'l Sets)	<b>233</b>
<b>K-498</b>	Tubular Overshelf 12" wide (Min. 3 Ft.)	<b>528 lin. ft.</b>
<b>K-499</b>	Stainless Steel Pot Rack	<b>419 lin. ft.</b>
<b>K-500</b>	Stainless Steel Apron to Cover Sink Bowls	<b>1316 ea.</b>
<b>K-500A</b>	17" Stainless Steel Apron to Cover Sink Bowls and Support Lever Drain Handles	<b>1530 ea.</b>
<b>K-508</b>	Special Sizing Charge (Larger size cut down to smaller size)	<b>N/C ea.</b>
<b>K-508A</b>	Special Modification Charge	<b>355 ea.</b>
<b>K-510</b>	Prepare Sink for Undercounter Dishwasher (24" drainboard or larger)	<b>198 per sink</b>
<b>K-520</b>	Poly Board/Stainless Steel Cover Holder	<b>941 ea.</b>
<b>K-550</b>	Stainless Steel Tubular Rack Storage	<b>289 lin. ft.</b>
<b>K-ROD</b>	Weld Support Rods For Poly Sink Cover In Corners Of Sink Bowl	<b>674 ea.</b>

## ACCESSORIES

<b>K-30</b>	Faucet Wall Mounting Bracket	<b>\$496 ea.</b>
<b>K-72</b>	Leg To Wall Brace	<b>415</b>
<b>K-350</b>	Residential Finish & Packaging	<b>503 ea.</b>
<b>K-397</b>	Wall Bracket for Sink (Includes 2 Brackets with K-495 Mod.)	<b>119 ea.</b>
<b>K-457</b>	Replacement Rubber Scrap Block (See K-456 for install cost)	<b>166 ea.</b>
<b>K-474</b>	16 ga., '304' Series S/S Leg with S/S Foot	<b>161 ea.</b>
<b>K-475</b>	S/S Leg with S/S Foot	<b>100 ea.</b>
<b>K-477</b>	Replacement Leg Clamp for Adjustable Cross-Bracing	<b>28 ea.</b>
<b>K-477C</b>	Replacement Corner Leg Clamp for Adjustable Cross-Bracing	<b>39 ea.</b>
<b>K-478</b>	Stainless Steel Bullet Foot	<b>40 ea.</b>
<b>K-488</b>	Flanged S/S Bullet Foot	<b>85 ea.</b>
<b>K-493</b>	16 ga., '304' Series S/S Welded Leg Assembly with S/S Feet	<b>532 ea.</b>
<b>K-494</b>	S/S Welded Leg Assembly with S/S Feet	<b>473 ea.</b>
<b>K-497</b>	Galv. Welded Leg Assembly with Plastic Feet	<b>317 ea.</b>
<b>K-497A</b>	Galv. Individual Legs with Plastic Feet	<b>114 set/4</b>
<b>K-496</b>	Leg Assembly For Grease Interceptor w/ Adj. Cross-Bracing & S/S Feet (For Grease Interceptors with 15" Ht. or less. Consult factory for larger Grease Interceptors)	<b>583 ea.</b>
<b>K-610</b>	Perforated Stainless Steel Sink Grid (Specify Bowl Size)	<b>1066 ea.</b>

## SINK COVERS

Choose Model # & Add The Proper Letter In Place Of The Underscore (\_).  
Example: K-2A or FC-455H

Bowl Size	FOR DEEP DRAWN BOWLS		FOR FABRICATED BOWLS	
	Poly Covers Model K-2_ \$413	S/S Covers Model K-455_ \$691	Poly Covers Model K-2_ \$413	S/S Covers Model FC-455_ \$691
10" x 14"	A	A	AF	A
12" x 20"	I	I	IF	I
14" x 14"	H	H	HF	H
14" x 16"	B	B	BF	B
15" x 15"	Not Available	Not Available	MF	M
15" x 24"	Not Available	Not Available	VF	V
16" x 20"	C	C	CF	C
18" x 18"	Not Available	Not Available	JF	J
18" x 24"	D	D	DF	D
20" x 20"	E	E	EF	E
20" x 24"	Not Available	Not Available	PF	P
20" x 28"	G	G	GF	G
20" x 30"	Not Available	Not Available	SF	S
24" x 30"	Not Available	Not Available	TF	T
24" x 24"	F	F	FF	F
24" x 36"	Not Available	Not Available	RF	R
30" x 30"	Not Available	Not Available	UF	U

Custom Covers Available. Consult Factory.

**K-ROD** Welded Support Rods for Poly Sink Covers in Corners of Sink Bowl (Replaces Standard Support Clips) **\$674 per bowl**

## Tubular KD Wall Mounted Drainage Shelves

Model #	Size	Price
<b>DT-6R-36</b>	3"	<b>\$1447</b>
<b>DT-6R-48</b>	4"	<b>1674</b>
<b>DT-6R-60</b>	5"	<b>1880</b>
<b>DT-6R-72</b>	6"	<b>2060</b>

- Stainless Steel
- 15" Deep
- 1-5/8" Diameter Stainless Steel Tubing



# FAUCETS & DRAINS

All Items On This Page  
Ship Via UPS

## For Sinks & Dishtables

### PRERINSE FAUCETS Wall Bracket Included

**SPEC-LINE  
HEAVY DUTY  
Splash Mounted  
Prerinse Faucet**  
DTA-53 **\$1266**



**Deck Mounted  
Prerinse Faucet**  
K-115 **\$1758**



**Splash Mounted  
Prerinse Faucet**  
K-116 **\$1758**



12" Add-A-Faucet for  
DTA-53 Prerinse  
Faucets  
K-117 **\$495**



12" Add-A-Faucet for  
K-115 & K-116  
Prerinse  
Faucets  
K-117-TS **\$771**



Replacement Hose  
Handle Not Included

K-113 **\$240**



Replacement  
Spray  
Head &  
Handle  
K-114 **\$273**



### HEAVY DUTY FAUCETS

**8" Swing Spout Faucet**  
8" O.C.  
K-1118 **\$630**



**16" Swing Spout Faucet**  
8" O.C.  
K-119 **\$733**



**12" Swing Spout Faucet**  
8" O.C.  
K-112 **\$674**



**18" Swing Spout Faucet**  
8" O.C.  
K-211 **\$784**



**14" Swing Spout Faucet**  
8" O.C.  
K-105 **\$704**



**Faucet Mounting Kit for**  
K-1, K-11, K-101, K-1105, K-119,  
K-119, K-127, K-128, K-129, K-159,  
K-161, K-1118, K-211 & DTA-53  
K-06 **\$136 Set of 2**



**Extra Heavy Duty  
T&S 14" Swing  
Spout Faucet**  
8" O.C.  
K-111 **\$848**



**Wall Mounted  
Service Faucet**

8" O.C.  
K-240 **\$1286**



*\*K-240 Does Not Meet Federal Lead Free Standards As It Is Not Intended For Potable Water.*

### STANDARD DUTY FAUCETS

Model	Spout Length	Price
K-101	8"	<b>\$316</b>
K-1	12"	<b>353</b>
K-11	14"	<b>403</b>



### WRIST HANDLES

For Standard Duty 8" O.C. Faucets  
Fits K-1, K-11 & K-101  
K-316-LU **\$167 set**



For Heavy Duty 8" O.C. Faucets  
Fits K-105, K-112, K-119, K-127, K-128, K-129, K-134,  
K-159, K-161, K-1118 & K-211  
K-416-LU **\$275 set**



For Extra Heavy Duty 8" O.C. Faucets  
Fits K-69, K-111, K-115, K-116 & K-117-TS  
K-416-TS-LU **\$492 set**



**Replacement Cartridges  
for K-1, K-11, K-101  
& K-160**

K-00B  
**\$151 (Set of 2)**



Repair Kit can only be used on  
faucets purchased after 1/2016

**Replacement Cartridges**

Fits K-105, K-112, K-119, K-127,  
K-128, K-129, K-159, K-161,  
K-1118 & K-211

K-07 **\$229 (Set of 2)**



**Vacuum Breaker  
Repair Kit For K-240**

K-03 **\$160**



**Faucet Wall  
Mounting  
Bracket**

K-30  
**\$443**

For use when no backsplash is  
available to mount faucet



### Heavy Duty Replacement Spouts

Model	Spout Size/Style	Price
K-1118SP	8" Swing Spout	<b>\$206</b>
K-1125P	12" Swing Spout	<b>220</b>
K-105SP	14" Swing Spout	<b>245</b>
K-119SP	16" Swing Spout	<b>256</b>
K-211SP	18" Swing Spout	<b>270</b>
Standard Duty Replacement Spouts		
K-101SP	8" Swing Spout	<b>96</b>
K-15P	12" Swing Spout	<b>116</b>
K-115P	14" Swing Spout	<b>125</b>

**Continuous Waste For  
3 Compartment Sink**



1-1/2" Dia.  
K-351  
**\$495**  
For Use with 2 & 3  
Compartment Sinks

**Chrome  
Plated  
P-Trap**



**Heavy Gauge  
(17 Gauge) 7-PS-10 \$187**  
**Standard Gauge  
(22 Gauge) 7-PS-14 \$166**

**Twist Handle  
Operated Drain**



2" IPS  
K-5 **\$388**  
Twist Drain  
Support Bracket  
K-4 **\$189**

**Twist Handle Operated  
Drain with Overflow**



K-15 **\$712**  
2" IPS

### Replacement Drains



1-1/2" IPS  
Assembly  
K-6 **\$64**



Basket  
K-310 **\$40**

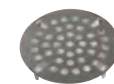

Strainer Plate for 3-1/2" Drain  
K-410 **\$34**

**SPEC-LINE Twist Handle  
Operated Drain**

K-40 **\$1273**

All  
Stainless Steel



**Replacement "O" Rings  
for Twist Handle  
Operated Drains**

For K-5 & K-15 Drains

K-05  
**\$28**  
Washer for  
Twist Handle



**WARNING:** Equipment that includes a faucet may expose you to chemicals, including lead, that are known to the State of California to cause cancer or birth defects or other reproductive harm. For more info., visit [www.p65warnings.ca.gov](http://www.p65warnings.ca.gov).

\*K-240 Service Faucet Does Not Meet Federal Lead Free Standards As It Is Not Intended For Potable Water.



# FLOOR TROUGHS

## Floor Troughs & Floor Drains

**Consult Factory For Additional Sizes**  
**Custom Sizes Available - Call For Pricing.**

**Ship Via UPS**

- 14 Gauge 304 Stainless Steel
- Stainless Steel Or Fiberglass Grating
- Pitched Towards Waste
- Subway Grating Constructed From 3/16" X 1" Bars

- Grating Is Spaced 9/16" (Inside Clearance) Between Bars To Prevent Casters From Getting Trapped
- Includes 4" Od. - 3" Long Plumbing Sleeve
- Includes Stainless Steel Strainer Basket With Handle

Size W x L x D	With S/S Grate	Price	Approx. Weight	With Fiberglass Grate	Price	Approx. Weight
12" x 24" x 4"	FTG-1224	\$4326	46 lbs.	FFTG-1224	\$4158	34 lbs.
12" x 30" x 4"	FTG-1230	4433	56 lbs.	FFTG-1230	4280	37 lbs.
12" x 36" x 4"	FTG-1236	4578	66 lbs.	FFTG-1236	4401	40 lbs.
12" x 42" x 4"	FTG-1242	4875	76 lbs.	FFTG-1242	4670	43 lbs.
12" x 48" x 4"	FTG-1248	5657	86 lbs.	FFTG-1248	5380	46 lbs.
12" x 54" x 4"	FTG-1254	6139	96 lbs.	FFTG-1254	5819	49 lbs.
12" x 60" x 4"	FTG-1260	6785	106 lbs.	FFTG-1260	6400	52 lbs.
12" x 72" x 4"	FTG-1272	7799	116 lbs.	FFTG-1272	7326	55 lbs.
12" x 84" x 4"	FTG-1284	9158	126 lbs.	FFTG-1284	8556	81 lbs.
12" x 96" x 4"	FTG-1296*	9427	146 lbs.	FFTG-1296*	8802	90 lbs.
12" x 108" x 4"	FTG-12108*	10236	166 lbs.	FFTG-12108*	9536	99 lbs.
12" x 120" x 4"	FTG-12120*	12396	180 lbs.	FFTG-12120*	11490	108 lbs.
18" x 24" x 4"	FTG-1824	4875	62 lbs.	FFTG-1824	4644	43 lbs.
18" x 30" x 4"	FTG-1830	5114	74 lbs.	FFTG-1830	4893	47 lbs.
18" x 36" x 4"	FTG-1836	5388	86 lbs.	FFTG-1836	5134	54 lbs.
18" x 42" x 4"	FTG-1842	5764	98 lbs.	FFTG-1842	5481	61 lbs.
18" x 48" x 4"	FTG-1848	6400	110 lbs.	FFTG-1848	6054	69 lbs.
18" x 54" x 4"	FTG-1854	7212	122 lbs.	FFTG-1854	6793	76 lbs.
18" x 60" x 4"	FTG-1860	7907	134 lbs.	FFTG-1860	7416	83 lbs.
18" x 72" x 4"	FTG-1872	8656	146 lbs.	FFTG-1872	8100	90 lbs.
18" x 84" x 4"	FTG-1884	10507	165 lbs.	FFTG-1884	9778	111 lbs.
18" x 96" x 4"	FTG-1896*	10776	187 lbs.	FFTG-1896*	10022	125 lbs.
18" x 108" x 4"	FTG-18108*	12396	208 lbs.	FFTG-18108*	11490	138 lbs.
18" x 120" x 4"	FTG-18120*	14281	229 lbs.	FFTG-18120*	13203	150 lbs.
24" x 24" x 4"	FTG-2424	5869	69 lbs.	FFTG-2424	4832	52 lbs.
24" x 30" x 4"	FTG-2430	6111	81 lbs.	FFTG-2430	5257	59 lbs.
24" x 36" x 4"	FTG-2436	6969	104 lbs.	FFTG-2436	5380	68 lbs.
24" x 42" x 4"	FTG-2442	7335	118 lbs.	FFTG-2442	5807	75 lbs.
24" x 48" x 4"	FTG-2448	8067	131 lbs.	FFTG-2448	6111	83 lbs.
24" x 54" x 4"	FTG-2454	8802	145 lbs.	FFTG-2454	6845	95 lbs.
24" x 60" x 4"	FTG-2460	9048	162 lbs.	FFTG-2460	7579	102 lbs.
24" x 72" x 4"	FTG-2472	10517	195 lbs.	FFTG-2472	8312	119 lbs.
24" x 84" x 4"	FTG-2484	11490	218 lbs.	FFTG-2484	9903	137 lbs.
24" x 96" x 4"	FTG-2496*	12712	243 lbs.	FFTG-2496*	10148	153 lbs.
24" x 108" x 4"	FTG-24108*	14429	274 lbs.	FFTG-24108*	11733	168 lbs.
24" x 120" x 4"	FTG-24120*	15402	310 lbs.	FFTG-24120*	13445	188 lbs.

\*Includes Two Drains

### 7.5" Wide Floor Water Receptacles (4" Depth)



- 14 Gauge 304 Stainless Steel
- Includes Stainless Steel Subway Grating constructed from 3/16" x 1" bars

Stainless Steel Grating	Size W x L x D	Price	Approx. Weight
FTG-724	7.5" x 24" x 4"	\$3079	44 lbs.
FTG-730	7.5" x 30" x 4"	3285	44 lbs.
FTG-736	7.5" x 36" x 4"	3482	63 lbs.
FTG-748	7.5" x 48" x 4"	4131	82 lbs.
FTG-760	7.5" x 60" x 4"	4462	101 lbs.
FTG-772	7.5" x 72" x 4"	4784	110 lbs.
FTG-784	7.5" x 84" x 4"	5110	119 lbs.
FTG-796	7.5" x 96" x 4"	5437	138 lbs.
FTG-7108	7.5" x 108" x 4"	5777	157 lbs.
FTG-7120	7.5" x 120" x 4"	6120	170 lbs.

### 12" Wide Floor Water Receptacles (2" Depth)



- 14 Gauge 304 Stainless Steel
- Includes Stainless Steel Subway Grating constructed from 3/16" x 1" bars

Stainless Steel Grating	Size W x L x D	Price	Approx. Weight
FRG-24	12" x 24" x 2"	\$4162	44 lbs.
FRG-36	12" x 36" x 2"	4747	63 lbs.
FRG-48	12" x 48" x 2"	5502	82 lbs.

### 12" Wide Floor Drain (4" Depth)

- 14 Gauge 304 Stainless Steel
- Includes Strainer Basket

**FD-1 \$941**

Optional Stainless Steel Grate



Stainless Steel Grating	Size W x L x D	Price	Approx. Weight
FDR-1212	12" x 12" x 4"	\$2157	26 lbs.

## FLOOR TROUGH ACCESSORIES & MODIFICATIONS

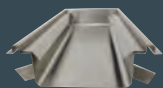

Cut-Out View  
of Anti-Splash

**FT-1 \$158 lin. ft.**

Optional Anti-Splash Guard  
(Factory Installed)

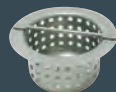

**FT-2 \$85 ea.**

Replacement Stainless Steel  
Strainer Basket with Handle

**FT-3 \$173 lin. ft.**

Modify Trough Depth  
(2" to 6" Deep)

**FT-4 \$360 per hole**

Modify Drain Outlet Size  
(Allow 2" to 8" Dia)

**FT-5 \$183 lin. ft.**

Grate Upgrade to A.D.A.

**FT-6 No Charge**

Modify Length of Trough  
(Select Next Larger Size)

# TABLES

## Flat Top W/ Undershef

Ship Via UPS

Stainless Steel TOP  
Stainless Steel UNDERSHELF  
Stainless Steel LEGS



VSS Series  
Countertop Edge



SS, MS, SAG Series  
Bull Nose Edge

### Spec-Line

### Premium

### Standard

### Super Saver

14 Ga. 304 S/S

14 Ga. 304 S/S

16 Ga. 304 S/S

16 Ga. 430 S/S

Approx.  
Shipping  
Weight

Approx.  
Cubic  
Feet

	Length	Spec-Line		Premium		Standard		Super Saver		Approx. Shipping Weight	Approx. Cubic Feet
		Model #	Price	Model #	Price	Model #	Price	Model #	Price		
<b>24" WIDE</b>	2'	VSS-242	\$2506	SS-242	\$1674	MS-242	\$1551	SAG-242	\$1506	31 lbs.	3
	30"	VSS-240	2696	SS-240	1857	MS-240	1714	SAG-240	1642	49 lbs.	4
	3'	VSS-243	2789	SS-243	1958	MS-243	1811	SAG-243	1735	64 lbs.	5
	4'	VSS-244	2869	SS-244	2044	MS-244	1880	SAG-244	1782	79 lbs.	6
	5'	VSS-245	3059	SS-245	2225	MS-245	2035	SAG-245	1929	92 lbs.	8
	6'	VSS-246	3244	SS-246	2411	MS-246	2203	SAG-246	2070	109 lbs.	9
	7'	VSS-247	4012	SS-247	3307	MS-247	3031	SAG-247	2552	130 lbs.	11
	8'	VSS-248	4243	SS-248	3542	MS-248	3243	SAG-248	2745	145 lbs.	12
	9'	VSS-249	4986	SS-249	4552	MS-249	4345	SAG-249	3909	161 lbs.	14
	10'	VSS-2410	5309	SS-2410	4874	MS-2410	4453	SAG-2410	4226	261 lbs.	26
	11'	VSS-2411	5764	SS-2411	5224	MS-2411	4753	SAG-2411	4480	293 lbs.	29
	12'	VSS-2412	5881	SS-2412	5337	MS-2412	4869	SAG-2412	4598	308 lbs.	32
<b>30" WIDE</b>	2'	VSS-302	2696	SS-302	1857	MS-302	1714	SAG-302	1642	55 lbs.	4
	30"	VSS-300	2805	SS-300	1971	MS-300	1821	SAG-300	1711	65 lbs.	5
	3'	VSS-303	2902	SS-303	2072	MS-303	1911	SAG-303	1826	72 lbs.	6
	4'	VSS-304	3022	SS-304	2197	MS-304	2012	SAG-304	1899	89 lbs.	8
	5'	VSS-305	3247	SS-305	2415	MS-305	2219	SAG-305	2082	107 lbs.	9
	6'	VSS-306	3599	SS-306	2527	MS-306	2280	SAG-306	2256	126 lbs.	11
	7'	VSS-307	4147	SS-307	3292	MS-307	3014	SAG-307	2651	148 lbs.	13
	8'	VSS-308	4316	SS-308	3643	MS-308	3421	SAG-308	2971	166 lbs.	15
	9'	VSS-309	5466	SS-309	4927	MS-309	4488	SAG-309	4197	176 lbs.	17
	10'	VSS-3010	5786	SS-3010	5247	MS-3010	4805	SAG-3010	4520	287 lbs.	32
	11'	VSS-3011	6207	SS-3011	5678	MS-3011	5178	SAG-3011	4843	324 lbs.	35
	12'	VSS-3012	6323	SS-3012	5795	MS-3012	5299	SAG-3012	4954	339 lbs.	37
<b>36" WIDE</b>	2'	VSS-362	3406	SS-362	2388	MS-362	2240	SAG-362	2061	81 lbs.	7
	3'	VSS-363	3458	SS-363	2438	MS-363	2296	SAG-363	2116	88 lbs.	7
	4'	VSS-364	3528	SS-364	2506	MS-364	2369	SAG-364	2190	98 lbs.	9
	5'	VSS-365	3791	SS-365	2768	MS-365	2605	SAG-365	2430	118 lbs.	11
	6'	VSS-366	4067	SS-366	3018	MS-366	2840	SAG-366	2659	138 lbs.	13
	7'	VSS-367	4965	SS-367	4093	MS-367	3867	SAG-367	3673	164 lbs.	16
	8'	VSS-368	5276	SS-368	4393	MS-368	4139	SAG-368	3966	184 lbs.	18
	9'	VSS-369	6423	SS-369	5864	MS-369	5485	SAG-369	5156	190 lbs.	20
	10'	VSS-3610	6739	SS-3610	6181	MS-3610	5805	SAG-3610	5478	308 lbs.	38
	11'	VSS-3611	7238	SS-3611	6695	MS-3611	6269	SAG-3611	5871	358 lbs.	41
	12'	VSS-3612	7357	SS-3612	6802	MS-3612	6380	SAG-3612	5984	373 lbs.	45
	<b>48" WIDE</b>	4'	VSS-484	6457	SS-484	5013	<b>NOT AVAILABLE</b>				158 lbs.
5'		VSS-485	6987	SS-485	5537	184 lbs.					15
6'		VSS-486	7505	SS-486	6048	218 lbs.					17
7'		VSS-487	9629	SS-487	8183	260 lbs.					20
8'		VSS-488	10286	SS-488	8831	290 lbs.					23
9'		VSS-489	11922	SS-489	10382	322 lbs.					44
10'		VSS-4810	12125	SS-4810	10584	522 lbs.					49
11'		VSS-4811	12328	SS-4811	10788	601 lbs.					54
12'	VSS-4812	12533	SS-4812	10992	616 lbs.	58					



Featuring as Standard: "THE PROVEN"  
Original ADVANCE TABCO Adjustable  
Undershef with Die Cast Leg Clamp

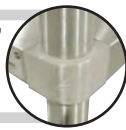

# TABLES

## Flat Top W/ Undershef



VLG Series  
Countertop Edge



GLG, MG, AG Series  
Bull Nose Edge



Stainless Steel TOP  
Galvanized UNDERSHELF  
Galvanized LEGS

### Spec-Line

### Premium

### Standard

### Super Saver

14 Ga. 304 S/S

14 Ga. 304 S/S

16 Ga. 304 S/S

16 Ga. 430 S/S

Approx.  
Shipping  
Weight

Approx.  
Cubic  
Feet

Length	Model #	Price	Model #	Price	Model #	Price	Model #	Price	Approx. Shipping Weight	Approx. Cubic Feet
<b>24" WIDE</b>	2' VLG-242	\$2012	GLG-242	\$1200	MG-242	\$1146	AG-242	\$1069	31 lbs.	3
	30" VLG-240	2152	GLG-240	1326	MG-240	1244	AG-240	1163	49 lbs.	4
	3' VLG-243	2247	GLG-243	1428	MG-243	1342	AG-243	1260	64 lbs.	5
	4' VLG-244	2288	GLG-244	1447	MG-244	1368	AG-244	1286	79 lbs.	6
	5' VLG-245	2415	GLG-245	1585	MG-245	1481	AG-245	1356	92 lbs.	8
	6' VLG-246	2569	GLG-246	1723	MG-246	1603	AG-246	1447	109 lbs.	9
	7' VLG-247	3134	GLG-247	2345	MG-247	2299	AG-247	1849	130 lbs.	11
	8' VLG-248	3313	GLG-248	2521	MG-248	2463	AG-248	2105	145 lbs.	12
	9' VLG-249	3790	GLG-249	3138	MG-249	2944	AG-249	2820	161 lbs.	14
	10' VLG-2410	4115	GLG-2410	3452	MG-2410	3267	AG-2410	3138	261 lbs.	26
	11' VLG-2411	4447	GLG-2411	3683	MG-2411	3452	AG-2411	3149	293 lbs.	29
	12' VLG-2412	4568	GLG-2412	3801	MG-2412	3568	AG-2412	3268	308 lbs.	32
<b>30" WIDE</b>	2' VLG-302	2152	GLG-302	1326	MG-302	1244	AG-302	1163	55 lbs.	4
	30" VLG-300	2207	GLG-300	1373	MG-300	1290	AG-300	1191	65 lbs.	5
	3' VLG-303	2302	GLG-303	1467	MG-303	1386	AG-303	1289	72 lbs.	6
	4' VLG-304	2363	GLG-304	1526	MG-304	1430	AG-304	1313	89 lbs.	8
	5' VLG-305	2534	GLG-305	1682	MG-305	1573	AG-305	1436	107 lbs.	9
	6' VLG-306	2703	GLG-306	1841	MG-306	1723	AG-306	1551	125 lbs.	11
	7' VLG-307	3273	GLG-307	2481	MG-307	2336	AG-307	1944	148 lbs.	13
	8' VLG-308	3501	GLG-308	2707	MG-308	2539	AG-308	2253	166 lbs.	15
	9' VLG-309	4147	GLG-309	3392	MG-309	3179	AG-309	2862	176 lbs.	17
	10' VLG-3010	4464	GLG-3010	3704	MG-3010	3502	AG-3010	3183	287 lbs.	32
	11' VLG-3011	4758	GLG-3011	4065	MG-3011	3737	AG-3011	3380	324 lbs.	35
	12' VLG-3012	4877	GLG-3012	4098	MG-3012	3853	AG-3012	3501	339 lbs.	37
<b>36" WIDE</b>	2' VLG-362	2718	GLG-362	1676	MG-362	1613	AG-362	1437	81 lbs.	7
	3' VLG-363	2772	GLG-363	1725	MG-363	1667	AG-363	1520	88 lbs.	7
	4' VLG-364	2844	GLG-364	1788	MG-364	1737	AG-364	1630	98 lbs.	9
	5' VLG-365	3060	GLG-365	2012	MG-365	1949	AG-365	1840	118 lbs.	11
	6' VLG-366	3267	GLG-366	2189	MG-366	2116	AG-366	2012	138 lbs.	13
	7' VLG-367	3939	GLG-367	2957	MG-367	2883	AG-367	2770	164 lbs.	16
	8' VLG-368	4128	GLG-368	3139	MG-368	3050	AG-368	2944	184 lbs.	18
	9' VLG-369	4924	GLG-369	4094	MG-369	3982	AG-369	3626	190 lbs.	20
	10' VLG-3610	5246	GLG-3610	4421	MG-3610	4300	AG-3610	3930	308 lbs.	38
	11' VLG-3611	5585	GLG-3611	4792	MG-3611	4613	AG-3611	4182	358 lbs.	41
	12' VLG-3612	5706	GLG-3612	4905	MG-3612	4723	AG-3612	4293	373 lbs.	45
	<b>48" WIDE</b>	4' VLG-484	5761	GLG-484	4321	<b>NOT AVAILABLE</b>				158 lbs.
5' VLG-485		6270	GLG-485	4832	184 lbs.					15
6' VLG-486		6683	GLG-486	4838	218 lbs.					17
7' VLG-487		8555	GLG-487	7115	260 lbs.					20
8' VLG-488		8982	GLG-488	7533	290 lbs.					23
9' VLG-489		10536	GLG-489	9002	322 lbs.					44
10' VLG-4810		10746	GLG-4810	9207	522 lbs.					49
11' VLG-4811		10948	GLG-4811	9413	601 lbs.					54
12' VLG-4812	11150	GLG-4812	9611	616 lbs.	58					

# TABLES

## Flat Top W/ Open Base

Stainless Steel TOP  
Stainless Steel LEGS



TVSS Series  
Countertop Edge



TSS, TMS, TSAG Series  
Bullnose Edge

### Spec-Line

### Premium

### Standard

### Super Saver

14 Ga. 304 S/S

14 Ga. 304 S/S

16 Ga. 304 S/S

16 Ga. 430 S/S

Approx.  
Shipping  
Weight

Approx.  
Cubic  
Feet

**24"  
WIDE**

Length	Model #	Price	Model #	Price	Model #	Price	Model #	Price	Approx. Shipping Weight	Approx. Cubic Feet
2'	TVSS-242	\$2690	TSS-242	\$1852	TMS-242	\$1734	TSAG-242	\$1682	25 lbs.	3
30"	TVSS-240	2869	TSS-240	2044	TMS-240	1892	TSAG-240	1822	42 lbs.	4
3'	TVSS-243	2971	TSS-243	2140	TMS-243	1988	TSAG-243	1916	53 lbs.	5
4'	TVSS-244	3054	TSS-244	2224	TMS-244	2059	TSAG-244	1964	64 lbs.	6
5'	TVSS-245	3242	TSS-245	2407	TMS-245	2219	TSAG-245	2099	74 lbs.	8
6'	TVSS-246	3431	TSS-246	2594	TMS-246	2386	TSAG-246	2248	85 lbs.	9
7'	TVSS-247	4189	TSS-247	3480	TMS-247	3216	TSAG-247	2734	103 lbs.	11
8'	TVSS-248	4428	TSS-248	3722	TMS-248	3430	TSAG-248	2924	114 lbs.	12
9'	TVSS-249	5179	TSS-249	4748	TMS-249	4330	TSAG-249	4094	130 lbs.	14
10'	TVSS-2410	5502	TSS-2410	5069	TMS-2410	4644	TSAG-2410	4421	227 lbs.	26
11'	TVSS-2411	5954	TSS-2411	5416	TMS-2411	4951	TSAG-2411	4673	251 lbs.	29
12'	TVSS-2412	6074	TSS-2412	5531	TMS-2412	5063	TSAG-2412	4786	266 lbs.	32

**30"  
WIDE**

2'	TVSS-302	2770	TSS-302	1939	TMS-302	1803	TSAG-302	1744	47 lbs.	4
30"	TVSS-300	2988	TSS-300	2158	TMS-300	2002	TSAG-300	1907	52 lbs.	5
3'	TVSS-303	3082	TSS-303	2253	TMS-303	2092	TSAG-303	2011	59 lbs.	6
4'	TVSS-304	3212	TSS-304	2382	TMS-304	2190	TSAG-304	2085	72 lbs.	8
5'	TVSS-305	3433	TSS-305	2605	TMS-305	2399	TSAG-305	2262	85 lbs.	9
6'	TVSS-306	3779	TSS-306	2831	TMS-306	2594	TSAG-306	2438	93 lbs.	11
7'	TVSS-307	4335	TSS-307	3630	TMS-307	3347	TSAG-307	2833	113 lbs.	13
8'	TVSS-308	4496	TSS-308	4012	TMS-308	3685	TSAG-308	3149	126 lbs.	15
9'	TVSS-309	5660	TSS-309	5122	TMS-309	4675	TSAG-309	4392	150 lbs.	17
10'	TVSS-3010	5974	TSS-3010	5435	TMS-3010	4996	TSAG-3010	4715	261 lbs.	32
11'	TVSS-3011	6402	TSS-3011	5866	TMS-3011	5368	TSAG-3011	5031	268 lbs.	35
12'	TVSS-3012	6516	TSS-3012	5982	TMS-3012	5481	TSAG-3012	5143	283 lbs.	37

**36"  
WIDE**

2'	TVSS-362	3587	TSS-362	2570	TMS-362	2421	TSAG-362	2240	70 lbs.	7
3'	TVSS-363	3641	TSS-363	2620	TMS-363	2475	TSAG-363	2299	75 lbs.	7
4'	TVSS-364	3714	TSS-364	2690	TMS-364	2549	TSAG-364	2378	82 lbs.	9
5'	TVSS-365	3975	TSS-365	2945	TMS-365	2782	TSAG-365	2609	96 lbs.	11
6'	TVSS-366	4253	TSS-366	3210	TMS-366	3018	TSAG-366	2840	108 lbs.	13
7'	TVSS-367	5148	TSS-367	4261	TMS-367	4034	TSAG-367	3861	127 lbs.	16
8'	TVSS-368	5456	TSS-368	4579	TMS-368	4330	TSAG-368	4138	140 lbs.	18
9'	TVSS-369	6619	TSS-369	6054	TMS-369	5680	TSAG-369	5346	165 lbs.	20
10'	TVSS-3610	6929	TSS-3610	6373	TMS-3610	5998	TSAG-3610	5667	261 lbs.	38
11'	TVSS-3611	7429	TSS-3611	6870	TMS-3611	6457	TSAG-3611	6069	290 lbs.	41
12'	TVSS-3612	7544	TSS-3612	6998	TMS-3612	6579	TSAG-3612	6181	305 lbs.	45

**48"  
WIDE**

4'	TVSS-484	6639	TSS-484	5188	<h1>NOT AVAILABLE</h1>				128 lbs.	12
5'	TVSS-485	7174	TSS-485	5727					148 lbs.	15
6'	TVSS-486	7679	TSS-486	6228					170 lbs.	17
7'	TVSS-487	9815	TSS-487	8364					206 lbs.	20
8'	TVSS-488	10461	TSS-488	9015					228 lbs.	23
9'	TVSS-489	12106	TSS-489	10579					260 lbs.	44
10'	TVSS-4810	12311	TSS-4810	10782					454 lbs.	49
11'	TVSS-4811	12513	TSS-4811	10986					517 lbs.	54
12'	TVSS-4812	12718	TSS-4812	11189	532 lbs.	58				

# TABLES

## Flat Top W/ Open Base



TVLG Series  
Countertop Edge



Stainless Steel TOP  
Galvanized LEGS

### Spec-Line

### Premium

### Standard

### Super Saver

14 Ga. 304 S/S

14 Ga. 304 S/S

16 Ga. 304 S/S

16 Ga. 430 S/S

Approx.  
Shipping  
Weight

Approx.  
Cubic  
Feet

Length	Model #	Price	Model #	Price	Model #	Price	Model #	Price	Approx. Shipping Weight	Approx. Cubic Feet
<b>24" WIDE</b>	2' TVLG-242	\$2190	TGLG-242	\$1376	TMG-242	\$1324	TAG-242	\$1251	25 lbs.	3
	30" TVLG-240	2333	TGLG-240	1508	TMG-240	1430	TAG-240	1342	42 lbs.	4
	3' TVLG-243	2423	TGLG-243	1603	TMG-243	1520	TAG-243	1439	53 lbs.	5
	4' TVLG-244	2467	TGLG-244	1632	TMG-244	1540	TAG-244	1464	64 lbs.	6
	5' TVLG-245	2605	TGLG-245	1767	TMG-245	1660	TAG-245	1537	74 lbs.	8
	6' TVLG-246	2749	TGLG-246	1896	TMG-246	1782	TAG-246	1632	85 lbs.	9
	7' TVLG-247	3317	TGLG-247	2533	TMG-247	2481	TAG-247	2031	103 lbs.	11
	8' TVLG-248	3491	TGLG-248	2698	TMG-248	2646	TAG-248	2292	114 lbs.	12
	9' TVLG-249	3982	TGLG-249	3523	TMG-249	3134	TAG-249	3004	130 lbs.	14
	10' TVLG-2410	4300	TGLG-2410	3847	TMG-2410	3449	TAG-2410	3324	227 lbs.	26
	11' TVLG-2411	4640	TGLG-2411	3879	TMG-2411	3654	TAG-2411	3340	251 lbs.	29
	12' TVLG-2412	4754	TGLG-2412	3990	TMG-2412	3770	TAG-2412	3452	266 lbs.	32
<b>30" WIDE</b>	2' TVLG-302	\$2221	TGLG-302	1397	TMG-302	1328	TAG-302	1262	47 lbs.	4
	30" TVLG-300	2388	TGLG-300	1551	TMG-300	1474	TAG-300	1375	52 lbs.	5
	3' TVLG-303	2482	TGLG-303	1651	TMG-303	1573	TAG-303	1471	59 lbs.	6
	4' TVLG-304	2543	TGLG-304	1713	TMG-304	1608	TAG-304	1496	72 lbs.	8
	5' TVLG-305	2717	TGLG-305	1870	TMG-305	1749	TAG-305	1616	85 lbs.	9
	6' TVLG-306	2892	TGLG-306	2025	TMG-306	1896	TAG-306	1734	93 lbs.	11
	7' TVLG-307	3457	TGLG-307	2659	TMG-307	2508	TAG-307	2121	113 lbs.	13
	8' TVLG-308	3686	TGLG-308	2894	TMG-308	2720	TAG-308	2434	126 lbs.	15
	9' TVLG-309	4340	TGLG-309	3573	TMG-309	3366	TAG-309	3060	150 lbs.	17
	10' TVLG-3010	4655	TGLG-3010	3903	TMG-3010	3685	TAG-3010	3380	261 lbs.	32
	11' TVLG-3011	4954	TGLG-3011	4167	TMG-3011	3929	TAG-3011	3566	268 lbs.	35
	12' TVLG-3012	5073	TGLG-3012	4286	TMG-3012	4043	TAG-3012	3683	283 lbs.	37
<b>36" WIDE</b>	2' TVLG-362	2897	TGLG-362	1847	TMG-362	1788	TAG-362	1676	70 lbs.	7
	3' TVLG-363	2952	TGLG-363	1899	TMG-363	1845	TAG-363	1737	75 lbs.	7
	4' TVLG-364	3022	TGLG-364	1970	TMG-364	1918	TAG-364	1818	82 lbs.	9
	5' TVLG-365	3243	TGLG-365	2190	TMG-365	2129	TAG-365	2023	96 lbs.	11
	6' TVLG-366	3452	TGLG-366	2369	TMG-366	2299	TAG-366	2190	108 lbs.	13
	7' TVLG-367	4124	TGLG-367	3142	TMG-367	3059	TAG-367	2949	127 lbs.	16
	8' TVLG-368	4313	TGLG-368	3319	TMG-368	3226	TAG-368	3088	140 lbs.	18
	9' TVLG-369	5113	TGLG-369	4291	TMG-369	4175	TAG-369	3809	165 lbs.	20
	10' TVLG-3610	5433	TGLG-3610	4611	TMG-3610	4494	TAG-3610	4125	261 lbs.	38
	11' TVLG-3611	5786	TGLG-3611	4987	TMG-3611	4805	TAG-3611	4370	290 lbs.	41
	12' TVLG-3612	5900	TGLG-3612	5102	TMG-3612	4921	TAG-3612	4492	305 lbs.	45
	<b>48" WIDE</b>	4' TVLG-484	5911	TGLG-484	4497	<b>NOT AVAILABLE</b>				128 lbs.
5' TVLG-485		6457	TGLG-485	5013	148 lbs.					15
6' TVLG-486		6998	TGLG-486	5425	170 lbs.					17
7' TVLG-487		8743	TGLG-487	7297	206 lbs.					20
8' TVLG-488		9155	TGLG-488	7709	228 lbs.					23
9' TVLG-489		10725	TGLG-489	9188	260 lbs.					44
10' TVLG-4810		10931	TGLG-4810	9394	454 lbs.					49
11' TVLG-4811		11136	TGLG-4811	9596	517 lbs.					54
12' TVLG-4812	11339	TGLG-4812	9802	532 lbs.	58					

# TABLES

## 1-1/2" Rear Splash W/ Undershef

Stainless Steel TOP  
Stainless Steel UNDERSHELF  
Stainless Steel LEGS

FSS, FMS, SFG Series  
Bullnose Edge



### Premium

### Standard

### Super Saver

14 Ga. 304 S/S

16 Ga. 304 S/S

16 Ga. 430 S/S

Approx. Shipping Weight  
Approx. Cubic Feet

Length	Model #	Price	Model #	Price	Model #	Price	Approx. Shipping Weight	Approx. Cubic Feet
<b>24" WIDE</b>	2'	FSS-242  \$1822	FMS-242  \$1696	SFG-242  \$1652	31 lbs.	3		
	30"	FSS-240  2011	FMS-240  1850	SFG-240  1784	49 lbs.	4		
	3'	FSS-243  2099	FMS-243  1949	SFG-243  1887	64 lbs.	5		
	4'	FSS-244  2189	FMS-244  2020	SFG-244  1933	79 lbs.	6		
	5'	FSS-245 2378	FMS-245 2178	SFG-245 2070	92 lbs.	8		
	6'	FSS-246 2560	FMS-246 2341	SFG-246 2210	109 lbs.	9		
	7'	FSS-247 3450	FMS-247 3172	SFG-247 2697	130 lbs.	11		
	8'	FSS-248 3685	FMS-248 3380	SFG-248 2894	145 lbs.	12		
	9'	FSS-249 4704	FMS-249 4291	SFG-249 4067	161 lbs.	14		
	10'	FSS-2410 5030	FMS-2410 4611	SFG-2410 4374	261 lbs.	26		
	11'	FSS-2411 5376	FMS-2411 4904	SFG-2411 4631	293 lbs.	29		
	12'	FSS-2412 5487	FMS-2412 5019	SFG-2412 4751	308 lbs.	32		
<b>30" WIDE</b>	2'	FSS-302  1896	FMS-302  1769	SFG-302  1714	55 lbs.	4		
	30"	FSS-300  2116	FMS-300  1964	SFG-300  1882	65 lbs.	5		
	3'	FSS-303  2210	FMS-303  2063	SFG-303  1970	72 lbs.	6		
	4'	FSS-304  2340	FMS-304  2158	SFG-304  2045	89 lbs.	8		
	5'	FSS-305 2569	FMS-305 2358	SFG-305 2224	107 lbs.	9		
	6'	FSS-306 2795	FMS-306 2560	SFG-306 2401	125 lbs.	11		
	7'	FSS-307 3599	FMS-307 3309	SFG-307 2802	148 lbs.	13		
	8'	FSS-308 3969	FMS-308 3654	SFG-308 3112	166 lbs.	15		
	9'	FSS-309 5091	FMS-309 4641	SFG-309 4360	176 lbs.	17		
	10'	FSS-3010 5401	FMS-3010 4956	SFG-3010 4673	287 lbs.	32		
	11'	FSS-3011 5823	FMS-3011 5328	SFG-3011 4994	324 lbs.	35		
	12'	FSS-3012 5948	FMS-3012 5444	SFG-3012 5105	339 lbs.	37		
<b>36" WIDE</b>	2'	FSS-362 2530	FMS-362 2396	SFG-362 2209	75 lbs.	7		
	3'	FSS-363 2583	FMS-363 2443	SFG-363 2265	88 lbs.	7		
	4'	FSS-364 2651	FMS-364 2508	SFG-364 2338	98 lbs.	9		
	5'	FSS-365 2912	FMS-365 2749	SFG-365 2576	118 lbs.	11		
	6'	FSS-366 3164	FMS-366 2988	SFG-366 2805	138 lbs.	13		
	7'	FSS-367 4236	FMS-367 4012	SFG-367 3816	164 lbs.	16		
	8'	FSS-368 4549	FMS-368 4288	SFG-368 4105	184 lbs.	18		
	9'	FSS-369 6016	FMS-369 5634	SFG-369 5306	190 lbs.	20		
	10'	FSS-3610 6332	FMS-3610 5954	SFG-3610 5630	223 lbs.	38		
	11'	FSS-3611 6839	FMS-3611 6417	SFG-3611 6023	350 lbs.	41		
	12'	FSS-3612 6959	FMS-3612 6536	SFG-3612 6146	365 lbs.	45		

Units 8 ft. and larger furnished with 6 legs. SPECIAL LENGTHS: Select next largest size. Add **Model # TA-61 No Charge** (ex. SS-306 with TA-61 size to 66" long).



Adjustable Single and Double  
Table Mounted Overshelves  
**See Pages 74.**



For Adjustable Components  
Featuring Potracks & Overshelves  
10", 12" 15" & 18"  
**See Page 80 & 81.**





Featuring as Standard: "THE PROVEN"  
Original ADVANCE TABCO Adjustable Undershelf  
with Die Cast Leg Clamp

# TABLES

## 1-1/2" Rear Splash W/ Undershelf



FLG, FMG, FAG Series  
Bullnose Edge

Stainless Steel TOP  
Galvanized UNDERSHELF  
Galvanized LEGS

**Premium**

**Standard**

**Super Saver**

14 Ga. 304 S/S

16 Ga. 304 S/S

16 Ga. 430 S/S

Approx.  
Shipping  
Weight

Approx.  
Cubic  
Feet

Length	Model #	Price	Model #	Price	Model #	Price	Approx. Shipping Weight	Approx. Cubic Feet
<b>24" WIDE</b>	2'	FLG-242 <b>\$1342</b>	FMG-242 <b>\$1289</b>	FAG-242 <b>\$1210</b>	31 lbs.	3		
	30"	FLG-240 <b>1474</b>	FMG-240 <b>1386</b>	FAG-240 <b>1311</b>	49 lbs.	4		
	3'	FLG-243 <b>1573</b>	FMG-243 <b>1486</b>	FAG-243 <b>1399</b>	64 lbs.	5		
	4'	FLG-244 <b>1599</b>	FMG-244 <b>1508</b>	FAG-244 <b>1419</b>	79 lbs.	6		
	5'	FLG-245 <b>1733</b>	FMG-245 <b>1621</b>	FAG-245 <b>1505</b>	92 lbs.	8		
	6'	FLG-246 <b>1857</b>	FMG-246 <b>1744</b>	FAG-246 <b>1599</b>	109 lbs.	9		
	7'	FLG-247 <b>2494</b>	FMG-247 <b>2451</b>	FAG-247 <b>1999</b>	130 lbs.	11		
	8'	FLG-248 <b>2660</b>	FMG-248 <b>2609</b>	FAG-248 <b>2256</b>	145 lbs.	12		
	9'	FLG-249 <b>3297</b>	FMG-249 <b>3100</b>	FAG-249 <b>2967</b>	161 lbs.	14		
	10'	FLG-2410 <b>3610</b>	FMG-2410 <b>3418</b>	FAG-2410 <b>3286</b>	261 lbs.	26		
	11'	FLG-2411 <b>3843</b>	FMG-2411 <b>3610</b>	FAG-2411 <b>3367</b>	293 lbs.	29		
	12'	FLG-2412 <b>3960</b>	FMG-2412 <b>3729</b>	FAG-2412 <b>3420</b>	308 lbs.	32		
<b>30" WIDE</b>	2'	FLG-302 <b>1368</b>	FMG-302 <b>1294</b>	FAG-302 <b>1228</b>	55 lbs.	4		
	30"	FLG-300 <b>1511</b>	FMG-300 <b>1438</b>	FAG-300 <b>1337</b>	65 lbs.	5		
	3'	FLG-303 <b>1612</b>	FMG-303 <b>1531</b>	FAG-303 <b>1436</b>	72 lbs.	6		
	4'	FLG-304 <b>1668</b>	FMG-304 <b>1571</b>	FAG-304 <b>1447</b>	89 lbs.	8		
	5'	FLG-305 <b>1835</b>	FMG-305 <b>1723</b>	FAG-305 <b>1575</b>	107 lbs.	9		
	6'	FLG-306 <b>1988</b>	FMG-306 <b>1857</b>	FAG-306 <b>1696</b>	125 lbs.	11		
	7'	FLG-307 <b>2627</b>	FMG-307 <b>2475</b>	FAG-307 <b>2087</b>	148 lbs.	13		
	8'	FLG-308 <b>2856</b>	FMG-308 <b>2686</b>	FAG-308 <b>2399</b>	166 lbs.	15		
	9'	FLG-309 <b>3542</b>	FMG-309 <b>3325</b>	FAG-309 <b>3014</b>	176 lbs.	17		
	10'	FLG-3010 <b>3860</b>	FMG-3010 <b>3654</b>	FAG-3010 <b>3337</b>	287 lbs.	32		
	11'	FLG-3011 <b>4129</b>	FMG-3011 <b>3900</b>	FAG-3011 <b>3526</b>	324 lbs.	35		
	12'	FLG-3012 <b>4248</b>	FMG-3012 <b>4012</b>	FAG-3012 <b>3653</b>	339 lbs.	37		
<b>36" WIDE</b>	2'	FLG-362 <b>1817</b>	FMG-362 <b>1766</b>	FAG-362 <b>1662</b>	75 lbs.	7		
	3'	FLG-363 <b>1870</b>	FMG-363 <b>1818</b>	FAG-363 <b>1711</b>	88 lbs.	7		
	4'	FLG-364 <b>1940</b>	FMG-364 <b>1889</b>	FAG-364 <b>1777</b>	98 lbs.	9		
	5'	FLG-365 <b>2158</b>	FMG-365 <b>2092</b>	FAG-365 <b>1979</b>	118 lbs.	11		
	6'	FLG-366 <b>2336</b>	FMG-366 <b>2265</b>	FAG-366 <b>2158</b>	138 lbs.	13		
	7'	FLG-367 <b>3108</b>	FMG-367 <b>3018</b>	FAG-367 <b>2913</b>	164 lbs.	16		
	8'	FLG-368 <b>3282</b>	FMG-368 <b>3197</b>	FAG-368 <b>3083</b>	184 lbs.	18		
	9'	FLG-369 <b>4250</b>	FMG-369 <b>4138</b>	FAG-369 <b>3777</b>	190 lbs.	20		
	10'	FLG-3610 <b>4569</b>	FMG-3610 <b>4323</b>	FAG-3610 <b>4094</b>	223 lbs.	38		
	11'	FLG-3611 <b>4952</b>	FMG-3611 <b>4761</b>	FAG-3611 <b>4333</b>	350 lbs.	41		
	12'	FLG-3612 <b>5069</b>	FMG-3612 <b>4884</b>	FAG-3612 <b>4450</b>	365 lbs.	45		

### SIDE SPLASH

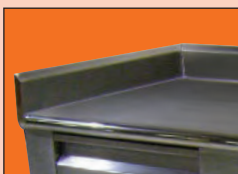

TA-30 1 1/2" Side Splash **\$130 ea.**  
TA-31 5" Side Splash **242 ea.**  
TA-32 10 1/2" Side Splash **474 ea.**

### K.D. ALUMINUM PAN RACK SLIDES

6 Slides - 2" Spacing  
Mounted on Tables (min. length 3")

TA-44  
**\$944**



Glass Rack Slides  
3 Slides - 7 1/2" Spacing  
TA-45 **\$862**

### WORKTABLE CASTERS

When Used with Galvanized Legs

TA-25G-4 **\$579/set of 4**  
TA-25G-6 **866/set of 6**

5" Swivels with rubber wheels  
Each set with 2 brakes. Legs  
maintain 35-1/2" working height

TA-25B **\$284** For Brakes on all wheels for  
TA-25SG-4 or TA-25G-6

TA-25C X.H.D. Urethane wheels  
**\$50** each caster

See Page 68 For More Casters



### 3 TIER DRAWERS



Stainless  
Steel

TA-38  
**\$5433**

20" x 20" x 5"  
Drawer Inserts with  
Ball Bearing Slides

### URN TROUGH



TA-64  
**\$229/lin.ft.**

# TABLES

## 1-1/2" Rear Splash W/ Open Base

Stainless Steel TOP  
Stainless Steel LEGS



TFSS, TFMS, TSFG Series  
Bullnose Edge



### Premium

### Standard

### Super Saver

14 Ga. 304 S/S

16 Ga. 304 S/S

16 Ga. 430 S/S

Approx.  
Shipping  
Weight

Approx.  
Cubic  
Feet

Length	Model #	Price	Model #	Price	Model #	Price	Approx. Shipping Weight	Approx. Cubic Feet	
<b>24" WIDE</b>	2'	TFSS-242	\$2002	TFMS-242	\$1882	TSFG-242	\$1857	25 lbs.	3
	30"	TFSS-240	2189	TFMS-240	2035	TSFG-240	1968	42 lbs.	4
	3'	TFSS-243	2288	TFMS-243	2134	TSFG-243	2065	53 lbs.	5
	4'	TFSS-244	2369	TFMS-244	2203	TSFG-244	2103	64 lbs.	6
	5'	TFSS-245	2552	TFMS-245	2358	TSFG-245	2248	74 lbs.	8
	6'	TFSS-246	2743	TFMS-246	2523	TSFG-246	2396	85 lbs.	9
	7'	TFSS-247	3626	TFMS-247	3354	TSFG-247	2883	103 lbs.	11
	8'	TFSS-248	3869	TFMS-248	3570	TSFG-248	3069	114 lbs.	12
	9'	TFSS-249	4897	TFMS-249	4486	TSFG-249	4250	130 lbs.	14
	10'	TFSS-2410	5223	TFMS-2410	4795	TSFG-2410	4569	227 lbs.	26
	11'	TFSS-2411	5565	TFMS-2411	5100	TSFG-2411	4826	251 lbs.	29
	12'	TFSS-2412	5684	TFMS-2412	5216	TSFG-2412	4918	266 lbs.	32
<b>30" WIDE</b>	2'	TFSS-302	2082	TFMS-302	1949	TSFG-302	1892	47 lbs.	4
	30"	TFSS-300	2234	TFMS-300	2144	TSFG-300	2060	52 lbs.	5
	3'	TFSS-303	2396	TFMS-303	2244	TSFG-303	2153	59 lbs.	6
	4'	TFSS-304	2521	TFMS-304	2338	TSFG-304	2225	72 lbs.	8
	5'	TFSS-305	2749	TFMS-305	2539	TSFG-305	2402	85 lbs.	9
	6'	TFSS-306	2974	TFMS-306	2648	TSFG-306	2583	93 lbs.	11
	7'	TFSS-307	3779	TFMS-307	3490	TSFG-307	2979	113 lbs.	13
	8'	TFSS-308	4139	TFMS-308	3826	TSFG-308	3292	126 lbs.	15
	9'	TFSS-309	5277	TFMS-309	4833	TSFG-309	4550	150 lbs.	17
	10'	TFSS-3010	5585	TFMS-3010	5147	TSFG-3010	4866	242 lbs.	32
	11'	TFSS-3011	6019	TFMS-3011	5514	TSFG-3011	5187	268 lbs.	35
	12'	TFSS-3012	6141	TFMS-3012	5635	TSFG-3012	5302	283 lbs.	37
<b>36" WIDE</b>	2'	TFSS-362	2715	TFMS-362	2571	TSFG-362	2406	65 lbs.	7
	3'	TFSS-363	2763	TFMS-363	2622	TSFG-363	2451	70 lbs.	7
	4'	TFSS-364	2833	TFMS-364	2696	TSFG-364	2511	77 lbs.	9
	5'	TFSS-365	3089	TFMS-365	2925	TSFG-365	2751	91 lbs.	11
	6'	TFSS-366	3348	TFMS-366	3164	TSFG-366	2988	103 lbs.	13
	7'	TFSS-367	4421	TFMS-367	4189	TSFG-367	4007	122 lbs.	16
	8'	TFSS-368	4725	TFMS-368	4465	TSFG-368	4286	135 lbs.	18
	9'	TFSS-369	6210	TFMS-369	5822	TSFG-369	5503	160 lbs.	20
	10'	TFSS-3610	6526	TFMS-3610	6148	TSFG-3610	5819	253 lbs.	38
	11'	TFSS-3611	7030	TFMS-3611	6611	TSFG-3611	6221	282 lbs.	41
	12'	TFSS-3612	7149	TFMS-3612	6732	TSFG-3612	6332	297 lbs.	45

Units 8 ft. and larger furnished with 6 legs. SPECIAL LENGTHS: Select next largest size. Add **Model # TA-61 No Charge** (ex. SS-306 with TA-61 size to 66" long).

### SELECTED SPEC-LINE UPGRADES

TA-3	Stainless Steel Hat Channel & Gusset	\$79 /lin. ft.
TA-94	16 ga. S/S 304 Undershelf. (any size)	75 /lin. ft.
TA-95	16 ga. S/S 304 Legs	185 /table
TA-23	Legs Welded to Undershelf or Cross-Rails, Shipped Set Up & Crated.	561 /table
TA-23A	Table Legs Welded To Leg Gussets & Undershelf or Cross-Bracing, Shipped Set Up & Crated.	741 /table

### WORKTABLE CASTERS

Maintains the 35-1/2" Working Height

TA-25S-4	4 Casters for Work Tables (2 w/ Brakes)	\$594 /set of 4
TA-25S-6	6 Casters for Work Tables (2 w/ Brakes)	897 /set of 6
TA-25	4 Casters for Open Base Tables (2 w/ Brakes)	594 /set of 4
TA-25A	6 Casters for Open Base Tables (2 w/ Brakes)	897 /set of 6

See Page 68 for More Caster Options

## 1-1/2" Rear Splash W/ Open Base

Stainless Steel TOP  
Galvanized LEGS



TFLG, TFMG, TFAG Series  
Bullnose Edge



### Premium

### Standard

### Super Saver

14 Ga. 304 S/S

16 Ga. 304 S/S

16 Ga. 430 S/S

Approx.  
Shipping  
Weight

Approx.  
Cubic  
Feet

	Length	Premium		Standard		Super Saver		Approx. Shipping Weight	Approx. Cubic Feet
		Model #	Price	Model #	Price	Model #	Price		
<b>24" WIDE</b>	2'	TFLG-242	\$1841	TFMG-242	\$1471	TFAG-242	\$1388	25 lbs.	3
	30"	TFLG-240	1653	TFMG-240	1571	TFAG-240	1487	42 lbs.	4
	3'	TFLG-243	1749	TFMG-243	1662	TFAG-243	1583	53 lbs.	5
	4'	TFLG-244	1779	TFMG-244	1686	TFAG-244	1608	64 lbs.	6
	5'	TFLG-245	1905	TFMG-245	1803	TFAG-245	1681	74 lbs.	8
	6'	TFLG-246	2044	TFMG-246	1933	TFAG-246	1779	85 lbs.	9
	7'	TFLG-247	2680	TFMG-247	2627	TFAG-247	2177	103 lbs.	11
	8'	TFLG-248	2844	TFMG-248	2789	TFAG-248	2438	114 lbs.	12
	9'	TFLG-249	3480	TFMG-249	3295	TFAG-249	3164	130 lbs.	14
	10'	TFLG-2410	3802	TFMG-2410	3607	TFAG-2410	3488	227 lbs.	26
	11'	TFLG-2411	4027	TFMG-2411	3802	TFAG-2411	3627	251 lbs.	29
	12'	TFLG-2412	4146	TFMG-2412	3912	TFAG-2412	3713	266 lbs.	32
<b>30" WIDE</b>	2'	TFLG-302	1540	TFMG-302	1475	TFAG-302	1410	47 lbs.	4
	30"	TFLG-300	1696	TFMG-300	1618	TFAG-300	1517	52 lbs.	5
	3'	TFLG-303	1788	TFMG-303	1714	TFAG-303	1616	59 lbs.	6
	4'	TFLG-304	1849	TFMG-304	1748	TFAG-304	1632	72 lbs.	8
	5'	TFLG-305	2012	TFMG-305	1896	TFAG-305	1762	85 lbs.	9
	6'	TFLG-306	2174	TFMG-306	2044	TFAG-306	1882	93 lbs.	11
	7'	TFLG-307	2805	TFMG-307	2658	TFAG-307	2266	113 lbs.	13
	8'	TFLG-308	3033	TFMG-308	2866	TFAG-308	2581	126 lbs.	15
	9'	TFLG-309	3729	TFMG-309	3523	TFAG-309	3214	150 lbs.	17
	10'	TFLG-3010	4046	TFMG-3010	3847	TFAG-3010	3526	242 lbs.	32
	11'	TFLG-3011	4323	TFMG-3011	4089	TFAG-3011	3728	268 lbs.	35
	12'	TFLG-3012	4437	TFMG-3012	4199	TFAG-3012	3843	283 lbs.	37
<b>36" WIDE</b>	2'	TFLG-362	2032	TFMG-362	1933	TFAG-362	1838	65 lbs.	7
	3'	TFLG-363	2068	TFMG-363	1990	TFAG-363	1889	70 lbs.	7
	4'	TFLG-364	2116	TFMG-364	2068	TFAG-364	1958	77 lbs.	9
	5'	TFLG-365	2338	TFMG-365	2273	TFAG-365	2168	91 lbs.	11
	6'	TFLG-366	2508	TFMG-366	2451	TFAG-366	2338	103 lbs.	13
	7'	TFLG-367	3287	TFMG-367	3210	TFAG-367	3099	122 lbs.	16
	8'	TFLG-368	3462	TFMG-368	3376	TFAG-368	3268	135 lbs.	18
	9'	TFLG-369	4516	TFMG-369	4330	TFAG-369	3964	160 lbs.	20
	10'	TFLG-3610	4758	TFMG-3610	4644	TFAG-3610	4285	253 lbs.	38
	11'	TFLG-3611	5139	TFMG-3611	4956	TFAG-3611	4527	282 lbs.	41
	12'	TFLG-3612	5250	TFMG-3612	5074	TFAG-3612	4640	297 lbs.	45

## QUICK METRIC CONVERSION TABLE

### CONVERT FROM

Inches  
Meters  
Meters  
Centimeters  
Millimeters  
Cubic Inches

### INTO

Cubic Feet  
Inches  
Feet  
Inches  
Inches  
Gallons

### MULTIPLY BY

L x W x H divided by 1728  
39.37  
3.28  
0.3937  
0.03937  
L x W x H Divided By 231

# TABLES

## 10" & 5" Rear Splash W/ Undershef

Stainless Steel TOP  
Stainless Steel UNDERSHELF  
Stainless Steel LEGS



VKS Series  
10" Back Splash  
Countertop Edge



KSS, KMS, SKG Series  
5" Back Splash  
Bullnose Edge



### Spec-Line

### Premium

### Standard

### Super Saver

14 Ga. 304 S/S

14 Ga. 304 S/S

16 Ga. 304 S/S

16 Ga. 430 S/S

Approx.  
Shipping  
Weight

Approx.  
Cubic  
Feet

Length	Model #	Price	Model #	Price	Model #	Price	Model #	Price	Approx. Shipping Weight	Approx. Cubic Feet
2'	VKS-242	\$3161	KSS-242	\$2163	KMS-242	\$2045	SKG-242	\$1943	50 lbs.	5
30"	VKS-240	3348	KSS-240	2349	KMS-240	2207	SKG-240	2179	55 lbs.	6
3'	VKS-243	3450	KSS-243	2452	KMS-243	2302	SKG-243	2275	66 lbs.	7
4'	VKS-244	3538	KSS-244	2549	KMS-244	2386	SKG-244	2330	81 lbs.	9
5'	VKS-245	3719	KSS-245	2745	KMS-245	2560	SKG-245	2467	95 lbs.	12
6'	VKS-246	3904	KSS-246	2944	KMS-246	2743	SKG-246	2617	113 lbs.	14
7'	VKS-247	4654	KSS-247	3779	KMS-247	3521	SKG-247	3099	135 lbs.	16
8'	VKS-248	4891	KSS-248	4023	KMS-248	3747	SKG-248	3287	150 lbs.	18
9'	VKS-249	5689	KSS-249	5123	KMS-249	4719	SKG-249	4486	165 lbs.	21
10'	VKS-2410	6013	KSS-2410	5444	KMS-2410	5040	SKG-2410	4795	268 lbs.	28
11'	VKS-2411	6460	KSS-2411	5819	KMS-2411	5369	SKG-2411	5062	301 lbs.	36
12'	VKS-2412	6580	KSS-2412	5941	KMS-2412	5485	SKG-2412	5173	316 lbs.	39
2'	VKS-302	3243	KSS-302	2234	KMS-302	2092	SKG-302	2103	56 lbs.	6
30"	VKS-300	3461	KSS-300	2473	KMS-300	2308	SKG-300	2273	70 lbs.	7
3'	VKS-303	3561	KSS-303	2564	KMS-303	2407	SKG-303	2373	77 lbs.	9
4'	VKS-304	3683	KSS-304	2698	KMS-304	2511	SKG-304	2451	92 lbs.	11
5'	VKS-305	3907	KSS-305	2937	KMS-305	2739	SKG-305	2622	111 lbs.	14
6'	VKS-306	4129	KSS-306	3180	KMS-306	2952	SKG-306	2789	129 lbs.	17
7'	VKS-307	4806	KSS-307	3920	KMS-307	3654	SKG-307	3069	153 lbs.	20
8'	VKS-308	5171	KSS-308	4311	KMS-308	4012	SKG-308	3511	171 lbs.	22
9'	VKS-309	6167	KSS-309	5503	KMS-309	5052	SKG-309	4775	289 lbs.	25
10'	VKS-3010	6488	KSS-3010	5819	KMS-3010	5383	SKG-3010	5093	294 lbs.	40
11'	VKS-3011	6908	KSS-3011	6271	KMS-3011	5786	SKG-3011	5416	331 lbs.	43
12'	VKS-3012	7026	KSS-3012	6384	KMS-3012	5900	SKG-3012	5531	346 lbs.	47
2'	VKS-362	4072	KSS-362	3054	KMS-362	2844	SKG-362	2602	86 lbs.	10
3'	VKS-363	4123	KSS-363	3104	KMS-363	2892	SKG-363	2659	92 lbs.	10
4'	VKS-364	4191	KSS-364	3172	KMS-364	2955	SKG-364	2734	101 lbs.	14
5'	VKS-365	4459	KSS-365	3576	KMS-365	3337	SKG-365	2971	121 lbs.	17
6'	VKS-366	4732	KSS-366	3841	KMS-366	3573	SKG-366	3210	142 lbs.	20
7'	VKS-367	5630	KSS-367	4579	KMS-367	4255	SKG-367	4213	169 lbs.	23
8'	VKS-368	5936	KSS-368	4902	KMS-368	4554	SKG-368	4503	189 lbs.	27
9'	VKS-369	7107	KSS-369	6557	KMS-369	6037	SKG-369	5737	260 lbs.	30
10'	VKS-3610	7432	KSS-3610	6873	KMS-3610	6355	SKG-3610	6054	315 lbs.	46
11'	VKS-3611	7935	KSS-3611	7400	KMS-3611	6831	SKG-3611	6448	358 lbs.	51
12'	VKS-3612	8056	KSS-3612	7520	KMS-3612	6949	SKG-3612	6568	373 lbs.	55

Units 8 ft. and larger furnished with 6 leg **SPECIAL LENGTHS:** Select next largest size. Add **Model # TA-61 No Charge** (ex. SS-306 with TA-61 size to 66" long).



PATENT PENDING



### Revolutionary SHD Series Drawer with Integral Drawer Slides

- Stainless Steel Front & Sides
- Self Closing Drawer with Noise Control
- Drawer "Safety Stop" Tab
- Removable Stainless Steel Insert
- Units can be Stacked to Create Tier Drawers

Model #	Insert Size	Price
SHD-2015	20" x 15" x 5"	\$1443
SHD-1520	15" x 20" x 5"	1443
SHD-2020	20" x 20" x 5"	1541

### DELUXE SERIES

- Stainless Steel Front
- Ball Bearing Slides
- Removable Insert

Stainless Steel		
Model #	Insert Size	Price
SS-2015	20" x 15" x 5"	\$791
SS-1520	15" x 20" x 5"	791
SS-2020	20" x 20" x 5"	856



See Pages 66-67 For More Drawer Details and More Drawer Options!



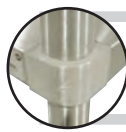

Featuring as Standard: "THE PROVEN"  
Original ADVANCE TABCO Adjustable Undershef  
with Die Cast Leg Clamp



# TABLES

## 10" & 5" Rear Splash W/ Undershef



VKG Series  
10" Back Splash  
Countertop Edge



KLG, KMG, KAG Series  
5" Back Splash  
Bullnose Edge

Spec-Line

Premium

Standard

Stainless Steel TOP  
Galvanized UNDERSHELF  
Galvanized LEGS  
Super Saver

	14 Ga. 304 S/S			14 Ga. 304 S/S			16 Ga. 304 S/S			16 Ga. 430 S/S		
	Length	Model #	Price	Model #	Price	Model #	Price	Model #	Price	Approx. Shipping Weight	Approx. Cubic Feet	
<b>24" WIDE</b>	2'	VKG-242	\$2768	KLG-242	\$1597	KMG-242	\$1559	KAG-242	\$1475	50 lbs.	5	
	30"	VKG-240	2913	KLG-240	1734	KMG-240	1682	KAG-240	1575	55 lbs.	6	
	3'	VKG-243	3012	KLG-243	1826	KMG-243	1779	KAG-243	1668	66 lbs.	7	
	4'	VKG-244	3059	KLG-244	1880	KMG-244	1819	KAG-244	1674	81 lbs.	9	
	5'	VKG-245	3212	KLG-245	2012	KMG-245	1949	KAG-245	1788	95 lbs.	12	
	6'	VKG-246	3358	KLG-246	2158	KMG-246	2085	KAG-246	1895	113 lbs.	14	
	7'	VKG-247	3957	KLG-247	2745	KMG-247	2658	KAG-247	2330	135 lbs.	16	
	8'	VKG-248	4147	KLG-248	2925	KMG-248	2864	KAG-248	2594	150 lbs.	18	
	9'	VKG-249	4758	KLG-249	3626	KMG-249	3479	KAG-249	3324	165 lbs.	21	
	10'	VKG-2410	5078	KLG-2410	3930	KMG-2410	3801	KAG-2410	3653	268 lbs.	28	
	11'	VKG-2411	5455	KLG-2411	4082	KMG-2411	4023	KAG-2411	3879	301 lbs.	36	
	12'	VKG-2412	5565	KLG-2412	4248	KMG-2412	4135	KAG-2412	3990	316 lbs.	39	
<b>30" WIDE</b>	2'	VKG-302	2794	KLG-302	1620	KMG-302	1575	KAG-302	1487	56 lbs.	6	
	30"	VKG-300	2960	KLG-300	1782	KMG-300	1734	KAG-300	1608	70 lbs.	7	
	3'	VKG-303	2944	KLG-303	1883	KMG-303	1826	KAG-303	1703	77 lbs.	9	
	4'	VKG-304	3139	KLG-304	1948	KMG-304	1889	KAG-304	1733	92 lbs.	11	
	5'	VKG-305	3322	KLG-305	2114	KMG-305	2044	KAG-305	1852	111 lbs.	14	
	6'	VKG-306	3498	KLG-306	2288	KMG-306	2208	KAG-306	1975	129 lbs.	17	
	7'	VKG-307	4105	KLG-307	2869	KMG-307	2780	KAG-307	2434	153 lbs.	20	
	8'	VKG-308	4366	KLG-308	3113	KMG-308	3009	KAG-308	2751	171 lbs.	22	
	9'	VKG-309	5144	KLG-309	3867	KMG-309	3713	KAG-309	3561	195 lbs.	25	
	10'	VKG-3010	5462	KLG-3010	4182	KMG-3010	4027	KAG-3010	3879	294 lbs.	40	
	11'	VKG-3011	5786	KLG-3011	4478	KMG-3011	4300	KAG-3011	4146	331 lbs.	43	
	12'	VKG-3012	5900	KLG-3012	4596	KMG-3012	4421	KAG-3012	4254	346 lbs.	47	
<b>36" WIDE</b>	2'	VKG-362	3518	KLG-362	2327	KMG-362	2257	KAG-362	2105	86 lbs.	10	
	3'	VKG-363	3576	KLG-363	2378	KMG-363	2296	KAG-363	2178	92 lbs.	10	
	4'	VKG-364	3658	KLG-364	2451	KMG-364	2345	KAG-364	2253	101 lbs.	14	
	5'	VKG-365	3889	KLG-365	2690	KMG-365	2605	KAG-365	2443	121 lbs.	17	
	6'	VKG-366	4104	KLG-366	2883	KMG-366	2781	KAG-366	2587	142 lbs.	20	
	7'	VKG-367	4826	KLG-367	3376	KMG-367	3255	KAG-367	3059	169 lbs.	23	
	8'	VKG-368	5023	KLG-368	3790	KMG-368	3665	KAG-368	3447	189 lbs.	27	
	9'	VKG-369	5973	KLG-369	4674	KMG-369	4492	KAG-369	4343	260 lbs.	30	
	10'	VKG-3610	6287	KLG-3610	4994	KMG-3610	4808	KAG-3610	4667	315 lbs.	46	
	11'	VKG-3611	6673	KLG-3611	5337	KMG-3611	5133	KAG-3611	4965	358 lbs.	51	
	12'	VKG-3612	6785	KLG-3612	5455	KMG-3612	5247	KAG-3612	5079	373 lbs.	55	

### SIDE SPLASH

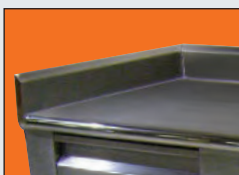

TA-30 1 1/2" Side Splash **\$130 ea.**  
TA-31 5" Side Splash **242 ea.**  
TA-32 10 1/2" Side Splash **474 ea.**

### K.D. ALUMINUM PAN RACK SLIDES

6 Slides - 2" Spacing  
Mounted on Tables (min. length 3")

TA-44  
**\$944**

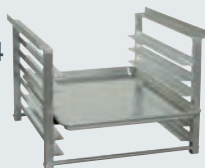

Glass Rack Slides  
3 Slides - 7 1/2" Spacing  
TA-45 **\$862**

### WORKTABLE CASTERS

When Used with Galvanized Legs

TA-25G-4 **\$594/set of 4**  
TA-25G-6 **897/set of 6**

5" Swivels with rubber wheels  
Each set with 2 brakes. Legs maintain 35-1/2" working height

TA-25B **\$284** For Brakes on all wheels for TA-25SG-4 or TA-25G-6

TA-25C X.H.D. Urethane wheels  
**\$50** each caster

See Page 68 For More Casters



### 3 TIER DRAWERS



Stainless Steel

TA-38  
**\$5433**

20" x 20" x 5"  
Drawer Inserts with Ball Bearing Slides

### URN TROUGH



TA-64  
**\$218/lin.ft.**

# TABLES

## 10" & 5" Rear Splash W/ Open Base

Stainless Steel TOP  
Stainless Steel LEGS



TVKS Series  
10" Back Splash  
Countertop Edge



TKSS, TKMS, TSKG Series  
5" Back Splash  
Bullnose Edge

### Spec-Line

### Premium

### Standard

### Super Saver

		14 Ga. 304 S/S		14 Ga. 304 S/S		16 Ga. 304 S/S		16 Ga. 430 S/S		Approx. Shipping Weight	Approx. Cubic Feet
Length	Model #	Price	Model #	Price	Model #	Price	Model #	Price			
<b>24" WIDE</b>	2'	TVKS-242 \$3347	TKSS-242 \$2340	TKMS-242 \$2225	TSKG-242 \$2225	43 lbs.	5				
	30"	TVKS-240 3528	TKSS-240 2534	TKMS-240 2388	TSKG-240 2363	49 lbs.	6				
	3'	TVKS-243 3628	TKSS-243 2630	TKMS-243 2482	TSKG-243 2460	55 lbs.	7				
	4'	TVKS-244 3716	TKSS-244 2732	TKMS-244 2560	TSKG-244 2505	67 lbs.	9				
	5'	TVKS-245 3903	TKSS-245 2924	TKMS-245 2743	TSKG-245 2647	77 lbs.	12				
	6'	TVKS-246 4088	TKSS-246 3128	TKMS-246 2922	TSKG-246 2794	89 lbs.	14				
	7'	TVKS-247 4837	TKSS-247 3953	TKMS-247 3695	TSKG-247 3273	107 lbs.	16				
	8'	TVKS-248 5072	TKSS-248 4203	TKMS-248 3924	TSKG-248 3464	119 lbs.	18				
	9'	TVKS-249 5876	TKSS-249 5310	TKMS-249 4905	TSKG-249 4674	135 lbs.	21				
	10'	TVKS-2410 6201	TKSS-2410 5635	TKMS-2410 5228	TSKG-2410 4994	234 lbs.	28				
	11'	TVKS-2411 6662	TKSS-2411 6014	TKMS-2411 5564	TSKG-2411 5247	258 lbs.	36				
	12'	TVKS-2412 6772	TKSS-2412 6130	TKMS-2412 5678	TSKG-2412 5361	273 lbs.	39				
<b>30" WIDE</b>	2'	TVKS-302 3430	TKSS-302 2413	TKMS-302 2291	TSKG-302 2291	48 lbs.	6				
	30"	TVKS-300 3651	TKSS-300 2648	TKMS-300 2490	TSKG-300 2457	55 lbs.	7				
	3'	TVKS-303 3744	TKSS-303 2748	TKMS-303 2587	TSKG-303 2549	62 lbs.	9				
	4'	TVKS-304 3868	TKSS-304 2896	TKMS-304 2697	TSKG-304 2627	75 lbs.	11				
	5'	TVKS-305 4093	TKSS-305 3123	TKMS-305 2919	TSKG-305 2804	89 lbs.	14				
	6'	TVKS-306 4316	TKSS-306 3358	TKMS-306 3134	TSKG-306 2979	97 lbs.	17				
	7'	TVKS-307 4990	TKSS-307 4104	TKMS-307 3826	TSKG-307 3376	118 lbs.	20				
	8'	TVKS-308 5350	TKSS-308 4489	TKMS-308 4189	TSKG-308 3689	131 lbs.	22				
	9'	TVKS-309 6367	TKSS-309 5694	TKMS-309 5253	TSKG-309 4969	150 lbs.	25				
	10'	TVKS-3010 6676	TKSS-3010 6014	TKMS-3010 5566	TSKG-3010 5298	249 lbs.	40				
	11'	TVKS-3011 7102	TKSS-3011 6464	TKMS-3011 5974	TSKG-3011 5607	276 lbs.	43				
	12'	TVKS-3012 7218	TKSS-3012 6582	TKMS-3012 6094	TSKG-3012 5720	291 lbs.	47				
<b>36" WIDE</b>	2'	TVKS-362 4253	TKSS-362 3227	TKMS-362 3012	TSKG-362 2786	75 lbs.	10				
	3'	TVKS-363 4302	TKSS-363 3282	TKMS-363 3068	TSKG-363 2840	80 lbs.	10				
	4'	TVKS-364 4370	TKSS-364 3354	TKMS-364 3139	TSKG-364 2913	85 lbs.	14				
	5'	TVKS-365 4638	TKSS-365 3766	TKMS-365 3515	TSKG-365 3149	99 lbs.	17				
	6'	TVKS-366 4908	TKSS-366 4025	TKMS-366 3764	TSKG-366 3378	112 lbs.	20				
	7'	TVKS-367 5810	TKSS-367 4763	TKMS-367 4440	TSKG-367 4391	131 lbs.	23				
	8'	TVKS-368 6119	TKSS-368 5085	TKMS-368 4741	TSKG-368 4686	145 lbs.	27				
	9'	TVKS-369 7300	TKSS-369 6742	TKMS-369 6226	TSKG-369 5921	165 lbs.	30				
	10'	TVKS-3610 7626	TKSS-3610 7058	TKMS-3610 6549	TSKG-3610 6241	268 lbs.	46				
	11'	TVKS-3611 8130	TKSS-3611 7597	TKMS-3611 7027	TSKG-3611 6640	298 lbs.	51				
	12'	TVKS-3612 8241	TKSS-3612 7704	TKMS-3612 7143	TSKG-3612 6757	313 lbs.	55				

Units 8 ft. and larger furnished with 6 legs. **SPECIAL LENGTHS:** Select next largest size. Add **Model # TA-61 No Charge** (ex. SS-306 with TA-61 size to 66" long).

### SELECTED SPEC-LINE UPGRADES

TA-3	Stainless Steel Hat Channel & Gusset	\$79 /lin. ft.
TA-94	16 ga. S/S 304 Undershef. (any size)	75 /lin. ft.
TA-95	16 ga. S/S 304 Legs	185 /table
TA-23	Legs Welded to Undershef or Cross-Rails, Shipped Set Up & Crated.	561 /table
TA-23A	Table Legs Welded To Leg Gussets & Undershef or Cross-Bracing, Shipped Set Up & Crated.	741 /table

### WORKTABLE CASTERS

Maintains the 35-1/2" Working Height

TA-25S-4	4 Casters for Work Tables (2 w/ Brakes)	\$594 /set of 4
TA-25S-6	6 Casters for Work Tables (2 w/ Brakes)	897 /set of 6
TA-25	4 Casters for Open Base Tables (2 w/ Brakes)	594 /set of 4
TA-25A	6 Casters for Open Base Tables (2 w/ Brakes)	897 /set of 6

See Page 68 for More Caster Options



TVKG Series  
10" Back Splash  
Countertop Edge



TKLG, TKMG, TKAG Series  
5" Back Splash  
Bullnose Edge

# TABLES

## 10" & 5" Rear Splash W/ Open Base



Stainless Steel TOP  
Galvanized LEGS

### Spec-Line

### Premium

### Standard

### Super Saver

14 Ga. 304 S/S

14 Ga. 304 S/S

16 Ga. 304 S/S

16 Ga. 430 S/S

Approx.  
Shipping  
Weight

Approx.  
Cubic  
Feet

Length	Model #	Price	Model #	Price	Model #	Price	Model #	Price	Approx. Shipping Weight	Approx. Cubic Feet
<b>24" WIDE</b>	2' TVKG-242	\$2945	TKLG-242	\$1777	TKMG-242	\$1735	TKAG-242	\$1657	43 lbs.	5
	30" TVKG-240	3099	TKLG-240	1907	TKMG-240	1870	TKAG-240	1762	49 lbs.	6
	3' TVKG-243	3193	TKLG-243	2011	TKMG-243	1964	TKAG-243	1850	55 lbs.	7
	4' TVKG-244	3242	TKLG-244	2059	TKMG-244	1999	TKAG-244	1896	67 lbs.	9
	5' TVKG-245	3380	TKLG-245	2190	TKMG-245	2129	TKAG-245	1971	77 lbs.	12
	6' TVKG-246	3542	TKLG-246	2338	TKMG-246	2265	TKAG-246	2080	89 lbs.	14
	7' TVKG-247	4135	TKLG-247	2924	TKMG-247	2834	TKAG-247	2505	107 lbs.	16
	8' TVKG-248	4335	TKLG-248	3112	TKMG-248	3014	TKAG-248	2780	119 lbs.	18
	9' TVKG-249	4956	TKLG-249	3809	TKMG-249	3673	TKAG-249	3522	135 lbs.	21
	10' TVKG-2410	5267	TKLG-2410	4125	TKMG-2410	3990	TKAG-2410	3843	234 lbs.	28
	11' TVKG-2411	5641	TKLG-2411	4369	TKMG-2411	4219	TKAG-2411	4070	258 lbs.	36
	12' TVKG-2412	5756	TKLG-2412	4485	TKMG-2412	4332	TKAG-2412	4182	273 lbs.	39
<b>30" WIDE</b>	2' TVKG-302	2973	TKLG-302	1795	TKMG-302	1762	TKAG-302	1667	48 lbs.	6
	30" TVKG-300	3143	TKLG-300	1964	TKMG-300	1907	TKAG-300	1784	55 lbs.	7
	3' TVKG-303	3242	TKLG-303	2063	TKMG-303	2011	TKAG-303	1887	62 lbs.	9
	4' TVKG-304	3319	TKLG-304	2127	TKMG-304	2068	TKAG-304	1905	75 lbs.	11
	5' TVKG-305	3498	TKLG-305	2296	TKMG-305	2224	TKAG-305	2039	89 lbs.	14
	6' TVKG-306	3685	TKLG-306	2467	TKMG-306	2390	TKAG-306	2164	97 lbs.	17
	7' TVKG-307	4286	TKLG-307	3054	TKMG-307	2955	TKAG-307	2619	118 lbs.	20
	8' TVKG-308	4549	TKLG-308	3292	TKMG-308	3192	TKAG-308	2934	131 lbs.	22
	9' TVKG-309	5341	TKLG-309	4054	TKMG-309	3908	TKAG-309	3755	150 lbs.	25
	10' TVKG-3010	5655	TKLG-3010	4370	TKMG-3010	4224	TKAG-3010	4070	249 lbs.	40
	11' TVKG-3011	5974	TKLG-3011	4671	TKMG-3011	4494	TKAG-3011	4333	276 lbs.	43
	12' TVKG-3012	6094	TKLG-3012	4784	TKMG-3012	4611	TKAG-3012	4450	291 lbs.	47
<b>36" WIDE</b>	2' TVKG-362	3725	TKLG-362	2401	TKMG-362	2340	TKAG-362	2311	75 lbs.	10
	3' TVKG-363	3766	TKLG-363	2453	TKMG-363	2386	TKAG-363	2364	80 lbs.	10
	4' TVKG-364	3829	TKLG-364	2523	TKMG-364	2453	TKAG-364	2434	85 lbs.	14
	5' TVKG-365	4063	TKLG-365	2867	TKMG-365	2782	TKAG-365	2622	99 lbs.	17
	6' TVKG-366	4285	TKLG-366	3059	TKMG-366	2957	TKAG-366	2770	112 lbs.	20
	7' TVKG-367	5004	TKLG-367	3561	TKMG-367	3449	TKAG-367	3242	131 lbs.	23
	8' TVKG-368	5204	TKLG-368	3971	TKMG-368	3841	TKAG-368	3611	145 lbs.	27
	9' TVKG-369	6159	TKLG-369	4869	TKMG-369	4684	TKAG-369	4540	165 lbs.	30
	10' TVKG-3610	6476	TKLG-3610	5187	TKMG-3610	5004	TKAG-3610	4850	268 lbs.	46
	11' TVKG-3611	6860	TKLG-3611	5531	TKMG-3611	5326	TKAG-3611	5162	298 lbs.	51
	12' TVKG-3612	6972	TKLG-3612	5641	TKMG-3612	5435	TKAG-3612	5268	313 lbs.	55

## Put a Sink in Your Table!

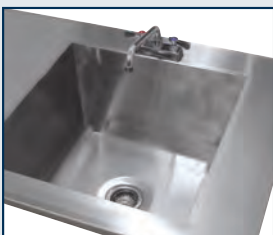

SINGLE & DOUBLE  
BOWLS AVAILABLE

For Integral Sinks  
See Page 65

## POLY-VANCE 5/8" THICK CUTTING BOARDS

Model #	Description	Price
K-2A	Cutting Board For 10"x14" Bowls	\$413 ea.
K-2B	Cutting Board For 14"x16" Bowls	413 ea.
K-2C	Cutting Board For 16"x20" Bowls	413 ea.
K-2D	Cutting Board For 18"x24" Bowls	413 ea.
K-2E	Cutting Board For 20"x20" Bowls	413 ea.
K-2F	Cutting Board For 24"x24" Bowls	413 ea.
K-2J	Cutting Board For 18"x18" Bowls	413 ea.
K-2K	Cutting Board For 30"x24" Bowls	413 ea.

For Faucets & Accessories - See Page 35-36

# TABLES

## Enclosed Base Tables

### FLAT TOP UNITS



\*Please add "M" after model number when adding Fixed Mid Shelf & refer to prices below

**14 GAUGE TOP**



Open Base



Sliding Doors



Hinged Doors



	L	Model #	w/ Fixed Mid-Shelf		Model #	# of Doors		w/ Fixed Mid-Shelf		Model #	# of Doors		w/ Fixed Mid-Shelf		Approx. Cubic Feet
			(Add "M")			(Add "M")		(Add "M")			(Add "M")				
<b>24" WIDE</b>	3'	EB-SS-243	\$3983	M \$4755	NOT AVAILABLE		2	\$6284	M \$7060	HB-SS-243	2	6589	M 7355	30	
	4'	EB-SS-244	4132	M 4898	CB-SS-244	2	\$5687	M \$6458	HB-SS-244	2	7022	M 7883	38		
	5'	EB-SS-245	4425	M 5283	CB-SS-245	2	6111	M 6977	HB-SS-245	2	7449	M 8418	47		
	6'	EB-SS-246	4716	M 5687	CB-SS-246	2	6552	M 7525	HB-SS-246	4	8384	M 9468	56		
	7'	EB-SS-247	5134	M 6213	CB-SS-247	4	7491	M 8573	HB-SS-247	4	8997	M 10163	66		
	8'	EB-SS-248	5397	M 6559	CB-SS-248	4	8093	M 9263	HB-SS-248	4	9977	M 11337	74		
	9'	EB-SS-249	6113	M 7471	CB-SS-249	4	9072	M 10431	HB-SS-249	4	10253	M 11608	83		
	10'	EB-SS-2410	6393	M 7747	CB-SS-2410	4	9354	M 10704	HB-SS-2410	4	13850	M 15572	92		
	12'	EB-SS-2412	8833	M 9911	CB-SS-2412	4	11450	M 13027	HB-SS-2412	6			109		
<b>30" WIDE</b>	3'	EB-SS-303	4199	M 5079	NOT AVAILABLE		2	6503	M 7302	HB-SS-303	2	6795	M 7678	35	
	4'	EB-SS-304	4351	M 5233	CB-SS-304	2	5903	M 6783	HB-SS-304	2	7278	M 8286	45		
	5'	EB-SS-305	4675	M 5687	CB-SS-305	2	6368	M 7376	HB-SS-305	2	7748	M 8867	55		
	6'	EB-SS-306	5012	M 6130	CB-SS-306	2	6842	M 7964	HB-SS-306	4	8600	M 9847	66		
	7'	EB-SS-307	5353	M 6598	CB-SS-307	4	7697	M 8946	HB-SS-307	4	9329	M 10722	76		
	8'	EB-SS-308	5911	M 7301	CB-SS-308	4	8428	M 9822	HB-SS-308	4	10379	M 12012	87		
	9'	EB-SS-309	6519	M 8141	CB-SS-309	4	9470	M 11098	HB-SS-309	4	10655	M 12290	97		
	10'	EB-SS-3010	6794	M 8417	CB-SS-3010	4	9746	M 11373	HB-SS-3010	4	14578	M 16294	107		
	12'	EB-SS-3012	9364	M 10439	CB-SS-3012	4	12672	M 14656	HB-SS-3012	6			128		
<b>36" WIDE</b>	3'	EB-SS-363	4500	M 5478	NOT AVAILABLE		2	6970	M 7939	HB-SS-363	2	7266	M 8236	41	
	4'	EB-SS-364	4644	M 5623	CB-SS-364	2	6295	M 7275	HB-SS-364	2	7770	M 8909	53		
	5'	EB-SS-365	4996	M 6131	CB-SS-365	2	6799	M 7938	HB-SS-365	2	8276	M 9562	65		
	6'	EB-SS-366	5584	M 6873	CB-SS-366	2	7307	M 8592	HB-SS-366	4	9186	M 10643	77		
	7'	EB-SS-367	5715	M 7160	CB-SS-367	4	8224	M 9673	HB-SS-367	4	9965	M 11484	90		
	8'	EB-SS-368	6314	M 7831	CB-SS-368	4	9010	M 10529	HB-SS-368	4	11107	M 13001	102		
	9'	EB-SS-369	6982	M 8881	CB-SS-369	4	10137	M 12041	HB-SS-369	4	11384	M 13284	114		
	10'	EB-SS-3610	7262	M 9162	CB-SS-3610	4	10410	M 12317	HB-SS-3610	4	15788	M 17701	126		
	12'	EB-SS-3612	9550	M 11241	CB-SS-3612	4	13442	M 15598	HB-SS-3612	6			151		

## 1-1/2" BACKSPLASH UNITS

Open Base

Sliding Doors

Hinged Doors

	L	Model #	w/ Fixed Mid-Shelf		Model #	# of Doors		w/ Fixed Mid-Shelf		Model #	# of Doors		w/ Fixed Mid-Shelf		Approx. Cubic Feet
			(Add "M")			(Add "M")		(Add "M")			(Add "M")				
<b>24" WIDE</b>	3'	EF-SS-243	\$3983	M \$4755	NOT AVAILABLE		2	\$6284	M \$7060	HF-SS-243	2	6589	M 7355	30	
	4'	EF-SS-244	4132	M 4898	CF-SS-244	2	\$5687	M \$6458	HF-SS-244	2	7022	M 7883	38		
	5'	EF-SS-245	4425	M 5283	CF-SS-245	2	6111	M 6977	HF-SS-245	2	7449	M 8418	47		
	6'	EF-SS-246	4716	M 5687	CF-SS-246	2	6552	M 7525	HF-SS-246	4	8384	M 9468	56		
	7'	EF-SS-247	5134	M 6213	CF-SS-247	4	7491	M 8573	HF-SS-247	4	8997	M 10163	66		
	8'	EF-SS-248	5397	M 6559	CF-SS-248	4	8093	M 9263	HF-SS-248	4	9977	M 11337	74		
	9'	EF-SS-249	6113	M 7471	CF-SS-249	4	9072	M 10431	HF-SS-249	4	10253	M 11608	83		
	10'	EF-SS-2410	6393	M 7747	CF-SS-2410	4	9354	M 10704	HF-SS-2410	4	13850	M 15572	92		
	12'	EF-SS-2412	8833	M 9911	CF-SS-2412	4	11450	M 13027	HF-SS-2412	6			109		
<b>30" WIDE</b>	3'	EF-SS-303	4199	M 5079	NOT AVAILABLE		2	6503	M 7381	HF-SS-303	2	6795	M 7678	35	
	4'	EF-SS-304	4351	M 5233	CF-SS-304	2	5903	M 6783	HF-SS-304	2	7278	M 8286	45		
	5'	EF-SS-305	4675	M 5687	CF-SS-305	2	6368	M 7376	HF-SS-305	2	7748	M 8867	55		
	6'	EF-SS-306	5008	M 6130	CF-SS-306	2	6842	M 7964	HF-SS-306	4	8600	M 9847	66		
	7'	EF-SS-307	5353	M 6598	CF-SS-307	4	7697	M 8946	HF-SS-307	4	9329	M 10722	76		
	8'	EF-SS-308	5911	M 7301	CF-SS-308	4	8428	M 9822	HF-SS-308	4	10379	M 12012	87		
	9'	EF-SS-309	6519	M 8141	CF-SS-309	4	9470	M 11098	HF-SS-309	4	10655	M 12282	97		
	10'	EF-SS-3010	6794	M 8417	CF-SS-3010	4	9746	M 11373	HF-SS-3010	4	14578	M 16294	107		
	12'	EF-SS-3012	9364	M 10439	CF-SS-3012	4	12672	M 14656	HF-SS-3012	6			128		

(Approx. Shipping Weight Is 50 Lbs. Per Lineal Foot)

FOR 36" WIDE 1-1/2" SPLASH UNITS: Use 36" Flat Top Price and Replace "B" with "F" (Example: EB-SS-364 would change to read EF-SS-364)

For Enclosed Base Tables Over 12' Add:

- TA-65 Open Base Units \$697 /lin. ft.
- TA-66 Sliding Door Units 1015 /lin. ft.
- TA-67 Hinged Door Units 1076 /lin. ft.

TA-36D \$176 ea.  
Hinged Door Repair Kit



\*Please add "M" after model number when adding Fixed Mid Shelf & refer to prices below



# TABLES

## Enclosed Base Tables

### 5" BACKSPLASH UNITS



Open Base



Sliding Doors



Hinged Doors

	L	Model #	w/ Fixed Mid-Shelf (Add "M")		Model #	# of Doors	w/ Fixed Mid-Shelf (Add "M")		Model #	# of Doors	w/ Fixed Mid-Shelf (Add "M")		Approx. Cubic Feet	
24" WIDE	3'	EK-SS-243	\$4109	M \$4803	NOT AVAILABLE				HK-SS-243	2	\$6417	M \$7191	30	
	4'	EK-SS-244	4258	M 4948	CK-SS-244	2	\$5809	M \$6589	HK-SS-244	2	6714	M 7484	38	
	5'	EK-SS-245	4557	M 5339	CK-SS-245	2	6251	M 7118	HK-SS-245	2	7149	M 8027	47	
	6'	EK-SS-246	4863	M 5751	CK-SS-246	2	6705	M 7740	HK-SS-246	4	7601	M 8580	56	
	7'	EK-SS-247	5295	M 6179	CK-SS-247	4	7645	M 8733	HK-SS-247	4	8548	M 9640	66	
	8'	EK-SS-248	5565	M 6641	CK-SS-248	4	8259	M 9425	HK-SS-248	4	9171	M 10336	74	
	9'	EK-SS-249	6311	M 7578	CK-SS-249	4	9266	M 10615	HK-SS-249	4	10165	M 11523	83	
	10'	EK-SS-2410	6591	M 7853	CK-SS-2410	4	9544	M 10897	HK-SS-2410	4	10443	M 11801	92	
	12'	EK-SS-2412	9048	M 10434	CK-SS-2412	4	12473	M 13982	HK-SS-2412	6	14121	M 15789	109	
	30" WIDE	3'	EK-SS-303	4464	M 5207	NOT AVAILABLE				HK-SS-303	2	6626	M 7511	35
		4'	EK-SS-304	4620	M 5355	CK-SS-304	2	6026	M 6904	HK-SS-304	2	6928	M 7810	45
		5'	EK-SS-305	4858	M 5869	CK-SS-305	2	6509	M 7523	HK-SS-305	2	7411	M 8425	55
6'		EK-SS-306	5072	M 6193	CK-SS-306	2	6992	M 8117	HK-SS-306	4	7893	M 9015	66	
7'		EK-SS-307	5507	M 6762	CK-SS-307	4	7858	M 9103	HK-SS-307	4	8768	M 11455	76	
8'		EK-SS-308	6082	M 7470	CK-SS-308	4	8595	M 9987	HK-SS-308	4	10063	M 11529	87	
9'		EK-SS-309	6706	M 8419	CK-SS-309	4	9667	M 11299	HK-SS-309	4	10569	M 12190	97	
10'		EK-SS-3010	6989	M 8600	CK-SS-3010	4	9947	M 11570	HK-SS-3010	4	10845	M 12693	107	
12'		EK-SS-3012	9547	M 10933	CK-SS-3012	4	13319	M 15094	HK-SS-3012	6	15278	M 16949	128	
36" WIDE		3'	EK-SS-363	4631	M 5598	NOT AVAILABLE				HK-SS-363	2	7094	M 8069	41
		4'	EK-SS-364	4778	M 5749	CK-SS-364	2	6428	M 7401	HK-SS-364	2	7395	M 8366	53
		5'	EK-SS-365	5108	M 6353	CK-SS-365	2	6952	M 8082	HK-SS-365	2	7909	M 9043	65
	6'	EK-SS-366	5721	M 7018	CK-SS-366	2	7462	M 8748	HK-SS-366	4	8426	M 9704	77	
	7'	EK-SS-367	5881	M 7322	CK-SS-367	4	8388	M 9842	HK-SS-367	4	9359	M 10802	90	
	8'	EK-SS-368	6489	M 8007	CK-SS-368	4	9180	M 10696	HK-SS-368	4	10747	M 12268	102	
	9'	EK-SS-369	7772	M 8997	CK-SS-369	4	10337	M 12236	HK-SS-369	4	11219	M 13114	114	
	10'	EK-SS-3610	8418	M 9271	CK-SS-3610	4	10529	M 12427	HK-SS-3610	4	11492	M 13388	126	
	12'	EK-SS-3612	9922	M 11755	CK-SS-3612	4	14279	M 16080	HK-SS-3612	6	16272	M 18037	151	

(Approx. shipping weight is 75 lbs. per lineal foot)

**We Recommend a Welded Field Joint For Units Over 12' TA-57 \$359 ea.**

(Units over 14' require a Welded or Bolted Field Joint)



## ECONOMY ENCLOSED BASE TABLES

- 16 Gauge, 304 Stainless Steel Top
- 18 Gauge, 430 Stainless Steel Body
- 1-5/8" Rolled Rim On front
- 1-5/8" Square Sides
- Fixed Mid Shelf
- Stainless Steel Legs & Bullet Feet



	L	FLAT TOP				5" BACK SPLASH				Approx. Cubic Feet
		SLIDING DOORS	List Price	HINGED DOORS	List Price	SLIDING DOORS	List Price	HINGED DOORS	List Price	
24" WIDE	36"	N/A		EHB-SS-243M	\$6436	N/A		EHK-SS-243M	\$6571	30
	48"	ECB-SS-244M	\$5825	EHB-SS-244M	6746	ECK-SS-244M	\$5983	EHK-SS-244M	6876	38
	60"	ECB-SS-245M	6255	EHB-SS-245M	7190	ECK-SS-245M	6402	EHK-SS-245M	7388	47
	72"	ECB-SS-246M	6712	EHB-SS-246M	7629	ECK-SS-246M	6868	EHK-SS-246M	7783	56
	84"	ECB-SS-247M	7670	EHB-SS-247M	8584	ECK-SS-247M	7828	EHK-SS-247M	8755	66
	96"	ECB-SS-248M	8287	EHB-SS-248M	9211	ECK-SS-248M	8457	EHK-SS-248M	9391	74
	108"	ECB-SS-249M	9290	EHB-SS-249M	10208	ECK-SS-249M	9491	EHK-SS-249M	10409	83
	120"	ECB-SS-2410M	9579	EHB-SS-2410M	10500	ECK-SS-2410M	9771	EHK-SS-2410M	10695	92
30" WIDE	36"	N/A		EHB-SS-303M	\$6659	N/A		EHK-SS-303M	\$6793	35
	48"	ECB-SS-304M	\$6046	EHB-SS-304M	6959	ECK-SS-304M	\$6171	EHK-SS-304M	7094	45
	60"	ECB-SS-305M	6522	EHB-SS-305M	7455	ECK-SS-305M	6666	EHK-SS-305M	7590	55
	72"	ECB-SS-306M	7009	EHB-SS-306M	7933	ECK-SS-306M	7162	EHK-SS-306M	8083	66
	84"	ECB-SS-307M	7884	EHB-SS-307M	8808	ECK-SS-307M	8048	EHK-SS-307M	8984	76
	96"	ECB-SS-308M	8634	EHB-SS-308M	9550	ECK-SS-308M	8801	EHK-SS-308M	10315	87
	108"	ECB-SS-309M	9698	EHB-SS-309M	10637	ECK-SS-309M	9896	EHK-SS-309M	10822	97
	120"	ECB-SS-3010M	9980	EHB-SS-3010M	10911	ECK-SS-3010M	10186	EHK-SS-3010M	11105	107

# TABLES

## Enclosed Base Tables



### ADJUSTABLE MID SHELF FOR ENCLOSED BASE TABLES

TA-116 **\$1174 Per Section**

Add To Price of Enclosed Base Table with Fixed Mid Shelf (M) On Page 50 & 51.  
(Shelves Over 36" In Length Require Multiple Sections With Center Partition. For Partial Shelves Add to Price of Shelf on Page 68.)

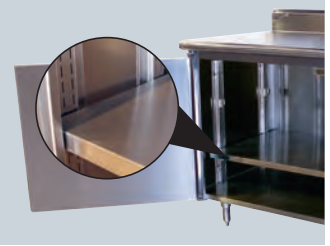

**30" Wide Units!**

Featuring SHD Series NSF Drawers



Hinged Doors



Sliding Doors

## ENCLOSED BASE TABLES WITH DRAWERS

Length	w/ Hinged Door		w/ Sliding Doors		# of Drawers	# of Doors	Weight	Cubic Feet
	Model #	Price	Model #	Price				
60"	HDRC-305	<b>\$10704</b>	SDRC-305	<b>\$10535</b>	2	2	300 lbs.	55
72"	HDRC-306	<b>11418</b>	SDRC-306	<b>11233</b>	2	4	360 lbs.	66
84"	HDRC-307	<b>13727</b>	SDRC-307	<b>13591</b>	3	4	420 lbs.	76
96"	HDRC-308	<b>13980</b>	SDRC-308	<b>13730</b>	3	4	540 lbs.	87
120"	HDRC-3010	<b>17670</b>	SDRC-3010	<b>17530</b>	4	4	600 lbs.	107

### MODIFICATIONS & ACCESSORIES

TA-105	Modified to 24" Width	<b>\$428 /table</b>	TA-14	Drawer Lock	<b>\$196 ea.</b>
TA-110	Modified to 36" Width	<b>80 /lin. ft.</b>	TA-46	Door Lock	<b>451 ea.</b>



## DISH CABINETS



Model #	Option	Price
TA-100F	Bullnose Front Top Edge	<b>\$155</b>
TA-101	Rear Tray Lock	<b>130 /lin. ft.</b>
TA-61	Special Sizing Charge (From Next Larger Size)	<b>N/C</b>

Length	15" WIDE				18" WIDE			
	Model #	Weight	Cu. Ft.	Price	Model #	Weight	Cu. Ft.	Price
48"	DC-154	155 lbs.	21	<b>\$4139</b>	DC-184	170 lbs.	25	<b>\$4421</b>
60"	DC-155	195 lbs.	27	<b>4426</b>	DC-185	205 lbs.	31	<b>4778</b>
72"	DC-156	225 lbs.	32	<b>4921</b>	DC-186	245 lbs.	36	<b>5853</b>
84"	DC-157	265 lbs.	37	<b>5130</b>	DC-187	275 lbs.	41	<b>6316</b>
96"	DC-158	295 lbs.	42	<b>5510</b>	DC-188	315 lbs.	46	<b>6795</b>
120"	DC-1510	360 lbs.	52	<b>6764</b>	DC-1810	385 lbs.	56	<b>7687</b>
144"	DC-1512	400 lbs.	62	<b>6963</b>	DC-1812	425 lbs.	66	<b>7894</b>

**30" Wide Units!**



Model BEV-30-84L  
Shown

## BEVERAGE TABLES



Length	Model #	Price	Weight	Cu. Ft.
4'	BEV-30-48LorR*	<b>\$9258</b>	230 lbs.	37
5'	BEV-30-60LorR*	<b>9830</b>	250 lbs.	45
6'	BEV-30-72LorR*	<b>10449</b>	270 lbs.	54
7'	BEV-30-84LorR*	<b>11965</b>	290 lbs.	63
8'	BEV-30-96LorR*	<b>12722</b>	330 lbs.	71
9'	BEV-30-108LorR*	<b>19103</b>	360 lbs.	76
10'	BEV-30-120LorR*	<b>19172</b>	380 lbs.	88
12'	BEV-30-144LorR*	<b>19412</b>	430 lbs.	96

Specify Sink Left Or Right End:

\*Please Designate Left Or Right Sink Location By Using L Or R After Model Number When Ordering.

**Sink Size 14" x 16" x 12"**

**Call For Installation of Buyout Equipment!**

Customize Your Own Beverage Table  
with Additional Accessories on Pages 61-68

TA-45 Optional Glass Rack Slide **\$862**

# SINK CABINETS

## Sink Cabinets

### SELF-CONTAINED MOBILE HAND SINKS



Bring The Sink On Location When Hand Washing Is Needed!

- 16 Ga., 304 Stainless Steel Top.
- K-52 Deck Mt. Gooseneck Faucet.
- Door Latch.
- 4" Plate Casters - 2 with Brakes.
- Hinged Door.
- Operates on a 120 Volt/15 Amp Circuit.
- 2-1/2 Gallon Electric Hot Water Heater (See Models Below).
- 6 Ft. Power Cord.
- Removable Plastic Container(s) for Fresh Water.
- Removable Plastic Container(s) for Waste Water.



SHK-MSC-26C Shown

w/ Cold Water Supply Only				w/ Hot & Cold Water Supply				Size L x W	Sink Bowl	Capacity (Gal.) Fresh/Waste
Model #	Dry Weight	Cu. Ft.	Price	Model #	Dry Weight	Cu. Ft.	Price			
SHK-MSC-26C	165 lbs.	21	<b>\$9823</b>	SHK-MSC-26CH	175 lbs.	21	<b>\$10429</b>	26" x 26"	10" x 14" x 5"	5/7
SHK-MSC-31C	185 lbs.	25	<b>10166</b>	SHK-MSC-31CH	195 lbs.	25	<b>11037</b>	31" x 26"	10" x 14" x 5"	10/14

### SELF-CONTAINED MOBILE HAND SINK ACCESSORIES & MODIFICATIONS



TA-MSC-1 Shown



TA-MSC-ES1 Shown

TA-MSC-1	Bolt-on Towel/Manual Soap Dispenser w/ Drip Tray for 26" Unit	<b>\$999</b>
TA-MSC-2	Bolt-on Towel/Manual Soap Dispenser w/ Drip Tray for 31" Unit	<b>1327</b>
TA-MSC-ES1	Bolt-on Towel/Touchless Soap Dispenser w/ Drip Tray for 26" Unit	<b>1293</b>
TA-MSC-ES2	Bolt-on Towel/Touchless Soap Dispenser w/ Drip Tray for 31" Unit	<b>1650</b>
TA-MSC-PC	10 ft. Power Cord	<b>358</b>
TA-46	Door Lock	<b>451</b>
K-12	Deck Mounted Soap Dispenser	<b>211</b>
K-316-LU	Wrist Handles For Faucet	<b>167</b>

### CORNER SINK CABINET



- Furnished With A 5" Splash With A 1" Return.
- SHK-2441 Designed To Line Up With "HK" 5" Rear Splash Enclosed Base Tables To Create Functional Work Area.
- Door Is A Double Panel Design.
- Utility Access Clearance Provided For Ease Of Plumbing Installation.
- Includes Sink With K-124 6" Extended Spout Faucet & Drain.
- Mitered Front Permits Easy Access To Sink Bowl & Faucet.



SHK-2441 Shown with Enclosed Base Line-Up.  
For Enclosed Base Table Options, See Pages 61-65.

Model #	Size L x W	Sink Bowl	Weight	Cu. Ft.	Price
SHK-1735	17" x 35"	14" x 10" x 10"	215 lbs.	38	<b>\$7604</b>
SHK-2441	24" x 41"	16" x 20" x 12"	250 lbs.	50	<b>8368</b>

### STANDARD SINK CABINET



- 5" Splash With A 1" Return On The Rear Side.
- Includes Sink And K-124 6" Extended Faucet & Drain.
- Hinged Door.

Model #	Size L x W	Sink Bowl	Dry Weight	Cu. Ft.	Price
SHK-302	24" x 30"	10" x 14" x 10"	150 lbs.	30	<b>\$6655</b>
<b>Space Saver Sink Cabinet</b>					
SHK-180	18" x 30"	10" x 14" x 10"	125 lbs.	30	<b>6086</b>



Add a 5" SIDE SPLASH  
TA-31 \$242 ea.

# WALL CABINETS

## 15" WIDE STAINLESS STEEL WALL CABINETS

18 Gauge, 430 Stainless Steel

Includes Fixed Mid-Shelf

SLIDING  
DOOR



OPEN  
UNIT



HINGED  
DOORS



Size L x W x H	W/ SLIDING DOORS				OPEN UNIT			W/ HINGED DOORS				Approx. Cu. Ft.
	Model #	Price	Doors	Approx. Weight	Model #	Price	Approx. Weight	Model #	Price	Doors	Approx. Weight	
36" x 15" x 32-1/2"	WCS-15-36	\$6983	2	130 lbs.	WCO-15-36	\$4982	95 lbs.	WCH-15-36	\$7341	2	120 lbs.	17
48" x 15" x 32-1/2"	WCS-15-48	7473	2	155 lbs.	WCO-15-48	5739	120 lbs.	WCH-15-48	7954	2	150 lbs.	21
60" x 15" x 32-1/2"	WCS-15-60	8638	2	185 lbs.	WCO-15-60	6265	145 lbs.	WCH-15-60	9107	2	180 lbs.	26
72" x 15" x 32-1/2"	WCS-15-72	9383	2	220 lbs.	WCO-15-72	7575	180 lbs.	WCH-15-72	9329	4	240 lbs.	31
96" x 15" x 32-1/2"	WCS-15-96	11790	4	295 lbs.	WCO-15-96	8121	240 lbs.	WCH-15-96	10550	4	320 lbs.	41

## STORAGE CABINETS



### 84" High Storage Cabinet w/ 4 Fixed Mid-Shelves

- Single Left-Hinged Door\*
- 4 Fixed Stainless Steel Mid-Shelves
- Enclosed Back Panel
- Ventilation Slots

Overall Size: 25"L x 22-5/8"W x 84"H

**CAB-4 \$8533**

18 Gauge, 430 Stainless Steel

**CAB-4-300 \$9368**

18 Gauge, 300 Stainless Steel



Vented  
Side Panels



### Wall Mounted Chemical Storage Cabinet w/ 1 Fixed Mid-Shelf

- Left-Hinged Door\*
- Vented Side Panels
- Mounting Hardware Not Included

Overall Size: 24"L x 15"W x 32-1/2"H

**WCH-15-24 \$6191**

18 Gauge, 430 Stainless Steel

**WCH-15-24-300 \$6860**

18 Gauge, 300 Stainless Steel

WCH-15-24 Left Hinged  
Shown (Standard)

\*Optional Right-Hand Door Swing Available - Add CAB-R N/C

## CABINET ACCESSORIES & MODIFICATIONS

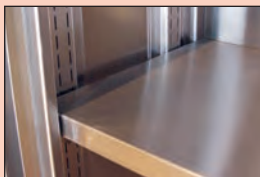

Adjustable Mid-Shelf

**TA-115 \$195 per lin. ft.**

Add to Price of 84" High Storage  
Cabinets or Wall Cabinets

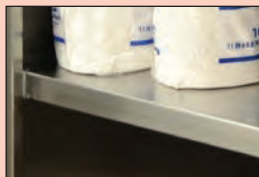

Additional Fixed Mid-Shelf

**WC-SHELF \$125 per lin. ft. K-94-SHELF \$521 ea.**

For WCS, WCO, WCH Series  
Wall Cabinets

For 84" High Storage Cabinet

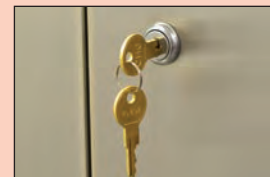

Cabinet Door Lock

**SU-27 \$451**

One Per Hinged Door or  
Pair of Sliding Doors



# SPECIALTY TABLES

## Specialty Tables

### DEMO TABLE

Countertop Edge  
Mirror Tilts to  
Desired Position



Model #	Table Size	Mirror Size	Wt.	Cu.	Price
VSS-DT-365	36" x 60"	24" x 48"	275 lbs.	18	<b>\$11252</b>
VSS-DT-366	36" x 72"	24" x 60"	305 lbs.	23	<b>13247</b>

### CEILING MOUNTED DEMO MIRROR

- 16 ga. type 304 Stainless Steel
- 1 5/8" Tubing - 4' Posts
- 14 ga. Rainbow Uprights For Added Support
- Glass Mirror



Model #	Mirror Size	Wt.	Cu.	Price
MI-48	24" x 48"	91 lbs.	7	<b>\$6324</b>
MI-60	24" x 60"	115 lbs.	8	<b>7421</b>

Mirror Tilts to  
Desired Position

PRINT REQUIRED

### CORNER TABLES 14 Gauge, 304 Stainless Steel

5" Rear Splash (1" Return)

Length	24" WIDE		30" WIDE		Wt.	Cu. Ft.
	Model #	Price	Model #	Price		
5'	KTMS-245	<b>\$9596</b>	KTMS-305	<b>\$9794</b>	280 lbs.	30
6'	KTMS-246	<b>9794</b>	KTMS-306	<b>9988</b>	300 lbs.	35
7'	KTMS-247	<b>9988</b>	KTMS-307	<b>10185</b>	320 lbs.	40
8'	KTMS-248	<b>10185</b>	KTMS-308	<b>10379</b>	345 lbs.	45
9'	KTMS-249	<b>10379</b>	KTMS-309	<b>10577</b>	375 lbs.	50
10'	KTMS-2410	<b>10577</b>	KTMS-3010	<b>10773</b>	400 lbs.	55
11'	KTMS-2411	<b>10773</b>	KTMS-3011	<b>10967</b>	425 lbs.	60
12'	KTMS-2412	<b>11164</b>	KTMS-3012	<b>11359</b>	450 lbs.	65

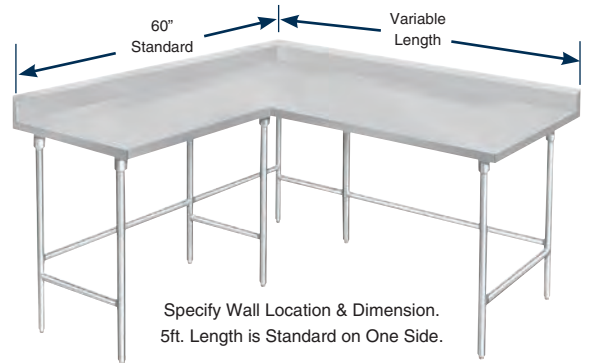

Specify Wall Location & Dimension.  
5ft. Length is Standard on One Side.

(Length can be modified, but not to  
exceed 7 ft. on one wall dimension)

TA-57 **\$320** Prepare Welded Field Joint

### Accessories

KT-100	36" Width On Corner Tables	<b>\$202 /lin. ft.</b>	KT-103	Stainless Steel Undershef	<b>\$85 /lin. ft.</b>
KT-101	Additional Length in Excess of 5'	<b>238 /lin. ft.</b>	KT-104	Stainless Steel Cabinet Base	<b>512 /lin. ft.</b>
KT-102	Special Sizing Charge	<b>N/C</b>		(Top Is Shipped Separately For Ease In Installation)	

### WORK TABLE WITH PREP SINK & FAUCET



- 16 ga., 304 Stainless Steel Top
- 5" Rear Splash
- 16" x 20" x 12" Sink Bowl
- Stainless Steel Adjustable Undershef
- 4 O.C. Deck Mounted Faucet & Basket Drain Included
- Stainless Steel Legs & Bullet Feet

Size	Model #	Sink Location	Price
30" x 48"	KMS-11B-304L	Left	<b>\$4517</b>
30" x 48"	KMS-11B-304R	Right	<b>4517</b>
30" x 60"	KMS-11B-305L	Left	<b>4744</b>
30" x 60"	KMS-11B-305R	Right	<b>4744</b>
30" x 72"	KMS-11B-306L	Left	<b>4958</b>
30" x 72"	KMS-11B-306R	Right	<b>4958</b>

CHOOSE  
LEFT OR RIGHT  
SINK POSITION

### PREP TABLE WITH COUNTERTOP EDGE



- 10" Rear Splash
- Includes 1 - 16" x 20" x 8" & 1 - 16" x 20" x 4" Integrally Welded Stainless Steel Sinks
- 21" x 18" x 5/8" Poly-Vance Cutting Board
- Stainless Steel Die-Formed Drawer
- Includes K-55 4" O.C. Gooseneck Faucet.

Model #	Size	Weight	Cu. Ft.	Price
DL-30-72	30" x 72"	155 lbs.	36	<b>\$8612</b>
DL-30-96	30" x 96"	198 lbs.	47	<b>9607</b>

See Page 65 For Additional Integral Sink Sizes

# MIXER TABLES

## Mixer Tables



Ship Via UPS

### MIXER TABLE WITH UTENSIL RACK

24" Work Height to Top of Table (Utensil Rack Has Height of 78")

Size	Stainless Steel Base		Galvanized Base		Wt.	Cu. Ft.
24" x 24"	<b>MX-SS-242</b>	<b>\$2800</b>	<b>MX-GL-242</b>	<b>\$2429</b>	53 lbs.	3
24" x 30"	<b>MX-SS-302</b>	<b>2897</b>	<b>MX-GL-302</b>	<b>2481</b>	63 lbs.	4
30" x 30"	<b>MX-SS-300</b>	<b>3110</b>	<b>MX-GL-300</b>	<b>2651</b>	70 lbs.	5
30" x 36"	<b>MX-SS-303</b>	<b>3153</b>	<b>MX-GL-303</b>	<b>2687</b>	77 lbs.	6
36" x 36"	<b>MX-SS-363</b>	<b>3238</b>	<b>MX-GL-363</b>	<b>2773</b>	81 lbs.	7

MX-SS-242  
Shown  
Mixer Not Included



### MIXER TABLE WITH UNDERSHELF

24" Work Height

Size	Stainless Steel Base		Galvanized Base		Wt.	Cu. Ft.
24" x 24"	<b>MT-SS-242</b>	<b>\$1675</b>	<b>MT-GL-242</b>	<b>\$1377</b>	45 lbs.	3
24" x 30"	<b>MT-SS-302</b>	<b>1760</b>	<b>MT-GL-302</b>	<b>1438</b>	50 lbs.	4
30" x 30"	<b>MT-SS-300</b>	<b>1995</b>	<b>MT-GL-300</b>	<b>1603</b>	55 lbs.	5
30" x 36"	<b>MT-SS-303</b>	<b>2026</b>	<b>MT-GL-303</b>	<b>1647</b>	68 lbs.	6
36" x 36"	<b>MT-SS-363</b>	<b>2124</b>	<b>MT-GL-363</b>	<b>1722</b>	71 lbs.	7

MT-SS-242  
Shown



### BUDGET MIXER TABLES

24" Work Height

Size	Stainless Steel Base		Galvanized Base		Wt.	Cu. Ft.
24" x 24"	<b>SAG-MT-242</b>	<b>\$1516</b>	<b>AG-MT-242</b>	<b>\$1230</b>	38 lbs.	3
24" x 30"	<b>SAG-MT-302</b>	<b>1592</b>	<b>AG-MT-302</b>	<b>1263</b>	41 lbs.	4
30" x 30"	<b>SAG-MT-300</b>	<b>1625</b>	<b>AG-MT-300</b>	<b>1289</b>	52 lbs.	5
30" x 36"	<b>SAG-MT-303</b>	<b>1733</b>	<b>AG-MT-303</b>	<b>1354</b>	58 lbs.	6
36" x 36"	<b>SAG-MT-363</b>	<b>1827</b>	<b>AG-MT-363</b>	<b>1445</b>	64 lbs.	7

AG-MT-242  
Shown



### MOBILE MIXER TABLES WITH TRAY SLIDES & CASTERS

28" Work Height. Tray Slides Have 2" Spacing

Size	Stainless Steel Base		Galvanized Base		Wt.	Cu. Ft.
30" x 30"	<b>MT-MS-300</b>	<b>\$2949</b>	<b>MT-MG-300</b>	<b>\$2560</b>	85 lbs.	9
30" x 36"	<b>MT-MS-303</b>	<b>2987</b>	<b>MT-MG-303</b>	<b>2606</b>	95 lbs.	10

MT-MG-300  
Shown



### MIXER EQUIPMENT TABLE

28" Work Height

Size	Model #	Price	Wt.	Cu. Ft.
24" x 30"	<b>AG-MP-30</b>	<b>\$2508</b>	65 lbs.	4

Add 15" x 20" Drawer SS-1520 **\$791**

Shown with  
Optional Drawer



#### CASTERS

MAINTAINS 24" WORKING HEIGHT

5" Swivels Each Set with 2 Brakes

For Use with  
Stainless Steel Legs  
TA-25ES **\$594 set/4**

For Use with  
Galvanized Legs  
TA-25EG **\$594 set/4**

### WALL MOUNTED TABLES

Must Be Installed In Cinder Block Wall  
Or Equal For Necessary Support



- Rolled Rim
- 1 1/2" Backsplash

Length	Model #	Price
30"	<b>FSS-W-240</b>	<b>\$2130</b>
24"	<b>FSS-W-242</b>	<b>1933</b>
36"	<b>FSS-W-243</b>	<b>2130</b>
48"	<b>FSS-W-244</b>	<b>2309</b>
60"	<b>FSS-W-245</b>	<b>2521</b>
72"	<b>FSS-W-246</b>	<b>2717</b>
84"	<b>FSS-W-247</b>	<b>3659</b>
96"	<b>FSS-W-248</b>	<b>3908</b>

Length	Model #	Price
30"	<b>FSS-W-300</b>	<b>\$2240</b>
24"	<b>FSS-W-302</b>	<b>2012</b>
36"	<b>FSS-W-303</b>	<b>2307</b>
48"	<b>FSS-W-304</b>	<b>2476</b>
60"	<b>FSS-W-305</b>	<b>2721</b>
72"	<b>FSS-W-306</b>	<b>2960</b>
84"	<b>FSS-W-307</b>	<b>3809</b>
96"	<b>FSS-W-308</b>	<b>4203</b>



Ship Via UPS

# STANDS

## Equipment Stands

### EQUIPMENT STANDS WITH UNDERSHELF



24" Working Height • 14 Ga. Type 304 Series • Up to 1000 lb. Load Capacity



Optional  
Heavy Duty Casters

TA-255 Set of 4 **\$791**

TA-256 Set of 6 **1047**

Each set supplied with  
2 Brakes

Length	Stainless Steel				Galvanized				Wt.	Cu. Ft.
	24" WIDE	Price	30" WIDE	Price	24" WIDE	Price	30" WIDE	Price		
2'	ES-242	<b>\$1795</b>	ES-302	<b>\$1879</b>	EG-242	<b>\$1573</b>	EG-302	<b>\$1610</b>	43 lbs.	4
3'	ES-243	<b>1993</b>	ES-303	<b>2105</b>	EG-243	<b>1736</b>	EG-303	<b>1800</b>	56 lbs.	6
4'	ES-244	<b>2184</b>	ES-304	<b>2342</b>	EG-244	<b>1951</b>	EG-304	<b>2002</b>	74 lbs.	8
5'	ES-245	<b>2382</b>	ES-305	<b>2585</b>	EG-245	<b>2063</b>	EG-305	<b>2206</b>	84 lbs.	9
6'	ES-246	<b>2577</b>	ES-306	<b>2815</b>	EG-246	<b>2226</b>	EG-306	<b>2402</b>	102 lbs.	11
7'	ES-247	<b>3214</b>	ES-307	<b>4315</b>	EG-247	<b>2728</b>	EG-307	<b>3747</b>	120 lbs.	13
8'	ES-248	<b>3286</b>	ES-308	<b>4390</b>	EG-248	<b>2796</b>	EG-308	<b>3820</b>	135 lbs.	15

For 36" Wide Equipment Stands Add TA-59 **\$373 per table**

### EQUIPMENT STANDS WITH UNDERSHELF & CASTERS



24" Working Height • 14 Ga. Type 304 Stainless Steel • Up to 1000 lb. Load Capacity



Length	30" WIDE	Price	Wt.	Cu. Ft.
2'	ES-302C	<b>\$2611</b>	51 lbs.	4
3'	ES-303C	<b>2835</b>	68 lbs.	6
4'	ES-304C	<b>3066</b>	85 lbs.	8
5'	ES-305C	<b>3300</b>	102 lbs.	9
6'	ES-306C	<b>3522</b>	119 lbs.	11

### MOBILE MACHINE STAND WITH WELDED SET-UP

14 Ga. Type 304 Stainless Steel

- Square Edge On All For Sides
- 25" W x 30" L x 20" H
- 1 5/8" Stainless Steel Legs with Heavy Duty Casters and Brakes
- Welded Undershef



MT-SS-250C  
**\$2686**



### Optional Equipment Stand Accessories



Wood Top Cutting Board  
w/ Plate Shelf Shown\*

\*Must Order Cutting Board When Ordering Plate Shelf

L	Adj. Wood Cutting Board		Adj. S/S Plate Shelf		Wt.	Cu. Ft.
	Model #	Price	Model #	Price		
2'	TA-922	<b>\$713</b>	TA-962	<b>\$690</b>	28 lbs.	1
3'	TA-923	<b>807</b>	TA-963	<b>780</b>	30 lbs.	2
4'	TA-924	<b>905</b>	TA-964	<b>861</b>	34 lbs.	3
5'	TA-925	<b>1002</b>	TA-965	<b>955</b>	37 lbs.	3
6'	TA-926	<b>1104</b>	TA-966	<b>1044</b>	40 lbs.	4
7'	TA-927	<b>1296</b>	TA-967	<b>1297</b>	56 lbs.	5
8'	TA-928	<b>1482</b>	TA-968	<b>1510</b>	64 lbs.	5

### EQUIPMENT FILLER TABLES



- Heavy Gauge Stainless Steel
- 1-1/2" Backsplash
- Stainless Steel Legs
- Stainless Steel Adjustable Bullet Feet



All Filler Tables Must Be Placed Between  
2 Other Pieces Of Equipment For Stability.

#### Open Base

Size	Model #	Price	Wt.	Cu. Ft.
12" x 24"	TFMS-122	<b>\$1286</b>	22 lbs.	2
12" x 30"	TFMS-120	<b>1396</b>	31 lbs.	2
12" x 36"	TFMS-123	<b>1482</b>	39 lbs.	2
15" x 24"	TFMS-152	<b>1414</b>	25 lbs.	2
15" x 30"	TFMS-150	<b>1541</b>	33 lbs.	2
15" x 36"	TFMS-153	<b>1630</b>	41 lbs.	3
18" x 24"	TFMS-182	<b>1425</b>	27 lbs.	2
18" x 30"	TFMS-180	<b>1559</b>	35 lbs.	3
18" x 36"	TFMS-183	<b>1610</b>	43 lbs.	3



#### w/ Adjustable Stainless Steel Undershef

Size	Model #	Price	Wt.	Cu. Ft.
15" x 24"	TFMSU-152	<b>\$1505</b>	28 lbs.	2
15" x 30"	TFMSU-150	<b>1595</b>	36 lbs.	2
15" x 36"	TFMSU-153	<b>1705</b>	41 lbs.	3
18" x 24"	TFMSU-182	<b>1542</b>	38 lbs.	2
18" x 30"	TFMSU-180	<b>1637</b>	41 lbs.	3
18" x 36"	TFMSU-183	<b>1745</b>	52 lbs.	3



# WOOD TOPS

## Wood Top Bakers Tables



All Wood Top Bakers Tables  
On Page 58 & 59 Feature  
1-3/4" Thick Wood Top



= Ship Via UPS

### FLAT TOP - OPEN BASE STYLE

#### Stainless Steel Base

L	24" WIDE	Price	Wt. (lbs.)	Cu. Ft.	30" WIDE	Price	Wt. (lbs.)	Cu. Ft.	36" WIDE	Price	Wt. (lbs.)	Cu. Ft.
4'	TH2S-244	\$1713	80	6	TH2S-304	\$1961	100	7	TH2S-364	\$2609	115	8
5'	TH2S-245	1918	95	7	TH2S-305	2235	120	9	TH2S-365	2974	135	11
6'	TH2S-246	2135	115	9	TH2S-306	2506	140	11	TH2S-366	3347	155	13
7'	TH2S-247	2627	135	10	TH2S-307	3144	155	12	TH2S-367	4189	180	15
8'	TH2S-248	2666	155	12	TH2S-308	3502	185	14	TH2S-368	4552	215	17



#### Galvanized Base

L	24" WIDE	Price	Wt. (lbs.)	Cu. Ft.	30" WIDE	Price	Wt. (lbs.)	Cu. Ft.	36" WIDE	Price	Wt. (lbs.)	Cu. Ft.
4'	TH2G-244	\$1346	80	6	TH2G-304	\$1505	100	7	TH2G-364	\$1800	115	8
5'	TH2G-245	1488	95	7	TH2G-305	1697	120	9	TH2G-365	2003	135	11
6'	TH2G-246	1630	115	9	TH2G-306	1881	140	11	TH2G-366	2196	155	13
7'	TH2G-247	1984	135	10	TH2G-307	2345	155	12	TH2G-367	2883	180	15
8'	TH2G-248	2338	155	12	TH2G-308	2712	185	14	TH2G-368	2923	215	17

### FLAT TOP - WITH ADJUSTABLE UNDERSHELF

#### Stainless Steel Base

L	24" WIDE	Price	Wt. (lbs.)	Cu. Ft.	30" WIDE	Price	Wt. (lbs.)	Cu. Ft.	36" WIDE	Price	Wt. (lbs.)	Cu. Ft.
3'	H2S-243	\$1713	75	4	H2S-303	\$1954	90	5	H2S-363	\$2578	105	6
4'	H2S-244	1821	95	6	H2S-304	2068	115	7	H2S-364	2682	135	8
5'	H2S-245	2068	110	7	H2S-305	2367	140	9	H2S-365	3083	160	11
6'	H2S-246	2309	130	9	H2S-306	2675	160	11	H2S-366	3473	185	13
7'	H2S-247	2866	150	10	H2S-307	3368	185	12	H2S-367	4381	215	15
8'	H2S-248	3225	180	12	H2S-308	3727	215	14	H2S-368	4744	255	17



#### Galvanized Base

L	24" WIDE	Price	Wt. (lbs.)	Cu. Ft.	30" WIDE	Price	Wt. (lbs.)	Cu. Ft.	36" WIDE	Price	Wt. (lbs.)	Cu. Ft.
3'	H2G-243	\$1406	75	4	H2G-303	\$1563	90	5	H2G-363	\$1859	105	6
4'	H2G-244	1511	95	6	H2G-304	1668	115	7	H2G-364	1969	135	8
5'	H2G-245	1701	110	7	H2G-305	1895	140	9	H2G-365	2210	160	11
6'	H2G-246	1885	130	9	H2G-306	2121	160	11	H2G-366	2452	185	13
7'	H2G-247	2312	150	10	H2G-307	2682	185	12	H2G-367	3010	215	15
8'	H2G-248	2672	180	12	H2G-308	3043	215	14	H2G-368	3368	255	17

### COVED TOP W/ 4" SPLASH - OPEN BASE STYLE

#### Stainless Steel Base

Length	30" WIDE	Price	Wt.	Cu. Ft.	36" WIDE	Price	Wt.	Cu. Ft.
4'	TBS-304	\$3846	120	12	TBS-364	\$5055	120	14
5'	TBS-305	4104	150	15	TBS-365	5410	150	18
6'	TBS-306	4815	180	18	TBS-366	6172	180	21
7'	TBS-307	5839	210	21	TBS-367	7703	210	24
8'	TBS-308	6191	240	24	TBS-368	8061	240	28

#### Galvanized Base

Length	30" WIDE	Price	Wt.	Cu. Ft.	36" WIDE	Price	Wt.	Cu. Ft.
4'	TBG-304	\$2919	120	12	TBG-364	\$3846	120	14
5'	TBG-305	3123	150	15	TBG-365	4136	150	18
6'	TBG-306	3751	180	18	TBG-366	4956	180	21
7'	TBG-307	4788	210	21	TBG-367	6338	210	24
8'	TBG-308	5144	240	24	TBG-368	6696	240	28

Features Coved Risers &  
Allow For Easy Cleaning



For Special Sizes & Configurations Of  
Wood Top Tables, Consult Factory.

For Additional Accessories & Modifications  
See Page 61 - 68 for Details



Coved Risers &  
Allow For Easy Cleaning!



# WOOD TOPS

## Wood Top Tables

### COVED TOP W/ 4" SPLASH & ADJUSTABLE UNDERSHELF



**Stainless Steel Base**

L	30" WIDE	Price	Wt.	Cu. Ft.	36" WIDE	Price	Wt. (lbs.)	Cu. Ft.
4'	BS-304	<b>\$4018</b>	160	15	BS-364	<b>\$5228</b>	190	17
5'	BS-305	<b>4323</b>	185	18	BS-365	<b>5628</b>	220	21
6'	BS-306	<b>4946</b>	225	21	BS-366	<b>6536</b>	265	25
7'	BS-307	<b>6181</b>	240	25	BS-367	<b>8056</b>	290	29
8'	BS-308	<b>6536</b>	275	28	BS-368	<b>8411</b>	350	33

**Galvanized Base**

L	30" WIDE	Price	Wt.	Cu. Ft.	36" WIDE	Price	Wt. (lbs.)	Cu. Ft.
4'	BG-304	<b>\$3091</b>	160	15	BG-364	<b>\$4018</b>	190	17
5'	BG-305	<b>3343</b>	185	18	BG-365	<b>4343</b>	220	21
6'	BG-306	<b>4015</b>	225	21	BG-366	<b>5226</b>	265	25
7'	BG-307	<b>5136</b>	240	25	BG-367	<b>6684</b>	290	29
8'	BG-308	<b>5493</b>	275	28	BG-368	<b>7043</b>	350	33

### COVED TOP W/ 4" SPLASH & 3-TIER DRAWERS



BST-306L Shown

**Stainless Steel Base**

L	30" WIDE	Price	Wt.	Cu. Ft.	36" WIDE	Price	Wt. (lbs.)	Cu. Ft.
4'	BST-304LorR	<b>\$6405</b>	365	46	BST-364LorR	<b>\$8444</b>	390	54
5'	BST-305LorR	<b>6821</b>	400	56	BST-365LorR	<b>8864</b>	430	66
6'	BST-306LorR	<b>7352</b>	440	67	BST-366LorR	<b>9560</b>	475	78
7'	BST-307LorR	<b>7802</b>	465	77	BST-367LorR	<b>10828</b>	505	91
8'	BST-308LorR	<b>8158</b>	500	87	BST-368LorR	<b>11210</b>	560	103

**Galvanized Base**

L	30" WIDE	Price	Wt.	Cu. Ft.	36" WIDE	Price	Wt. (lbs.)	Cu. Ft.
4'	BGT-304LorR	<b>\$5551</b>	365	46	BGT-364LorR	<b>\$7260</b>	390	54
5'	BGT-305LorR	<b>5757</b>	400	56	BGT-365LorR	<b>7491</b>	430	66
6'	BGT-306LorR	<b>6431</b>	440	67	BGT-366LorR	<b>8273</b>	475	78
7'	BGT-307LorR	<b>7535</b>	465	77	BGT-367LorR	<b>9570</b>	505	91
8'	BGT-308LorR	<b>7893</b>	500	87	BGT-368LorR	<b>10022</b>	560	103

# COUNTERTOPS



## Stainless Steel Countertops

- 16 Gauge Type 304 S/S
- Stud Welded Hat Channel
- #4 Satin Finish
- Sound Deadening
- No-Drip "Mirror Hi-Lite Polish" Edge

Countertop Shown  
with Optional Side Splash  
& Sink Bowl



Size	Flat Top	Price	Approx. Wt.	Approx. Cu. Ft.	5" Backsplash	Price	Approx. Wt.	Approx. Cu. Ft.	10" Backsplash	Price	Approx. Wt.	Approx. Cu. Ft.
25" x 30"	VCTC-240	<b>\$1716</b>	28 lbs.	4	VCTF-240	<b>\$1927</b>	28 lbs.	4	VKCT-240	<b>\$2144</b>	28 lbs.	4
25" x 36"	VCTC-243	<b>1716</b>	39 lbs.	5	VCTF-243	<b>1927</b>	39 lbs.	5	VKCT-243	<b>2144</b>	39 lbs.	5
25" x 48"	VCTC-244	<b>1895</b>	49 lbs.	6	VCTF-244	<b>2116</b>	49 lbs.	6	VKCT-244	<b>2358</b>	49 lbs.	6
25" x 60"	VCTC-245	<b>2085</b>	58 lbs.	8	VCTF-245	<b>2303</b>	58 lbs.	8	VKCT-245	<b>2563</b>	58 lbs.	8
25" x 72"	VCTC-246	<b>2265</b>	68 lbs.	9	VCTF-246	<b>2503</b>	68 lbs.	9	VKCT-246	<b>2780</b>	68 lbs.	9
25" x 84"	VCTC-247	<b>2802</b>	85 lbs.	11	VCTF-247	<b>2999</b>	85 lbs.	11	VKCT-247	<b>3333</b>	85 lbs.	11
25" x 96"	VCTC-248	<b>3004</b>	95 lbs.	12	VCTF-248	<b>3213</b>	95 lbs.	12	VKCT-248	<b>3562</b>	95 lbs.	12
25" x 120"	VCTC-2410	<b>4113</b>	201 lbs.	26	VCTF-2410	<b>4381</b>	201 lbs.	26	VKCT-2410	<b>4865</b>	201 lbs.	26
30" x 30"	VCTC-300	<b>1845</b>	38 lbs.	5	VCTF-300	<b>2025</b>	38 lbs.	5	VKCT-300	<b>2251</b>	38 lbs.	5
30" x 36"	VCTC-303	<b>1845</b>	45 lbs.	6	VCTF-303	<b>2025</b>	45 lbs.	6	VKCT-303	<b>2251</b>	45 lbs.	6
30" x 48"	VCTC-304	<b>2044</b>	57 lbs.	8	VCTF-304	<b>2255</b>	57 lbs.	8	VKCT-304	<b>2521</b>	57 lbs.	8
30" x 60"	VCTC-305	<b>2275</b>	69 lbs.	9	VCTF-305	<b>2493</b>	69 lbs.	9	VKCT-305	<b>2770</b>	69 lbs.	9
30" x 72"	VCTC-306	<b>2563</b>	76 lbs.	11	VCTF-306	<b>2720</b>	76 lbs.	11	VKCT-306	<b>3025</b>	76 lbs.	11
30" x 84"	VCTC-307	<b>2954</b>	95 lbs.	13	VCTF-307	<b>3142</b>	95 lbs.	13	VKCT-307	<b>3493</b>	95 lbs.	13
30" x 96"	VCTC-308	<b>3196</b>	107 lbs.	15	VCTF-308	<b>3220</b>	107 lbs.	15	VKCT-308	<b>3860</b>	107 lbs.	15
30" x 120"	VCTC-3010	<b>4590</b>	235 lbs.	32	VCTF-3010	<b>4694</b>	235 lbs.	32	VKCT-3010	<b>5226</b>	235 lbs.	32

# POLY TOPS

## Poly Top Bakers Tables



### FLAT TOP Tubular Base



Length	24" WIDE	Price	30" WIDE	Price	Wt.	Cu. Ft.
4'	TSPT-244	<b>\$2188</b>	TSPT-304	<b>\$2369</b>	77 lbs.	8
5'	TSPT-245	<b>2396</b>	TSPT-305	<b>2563</b>	89 lbs.	9
6'	TSPT-246	<b>3199</b>	TSPT-306	<b>3389</b>	117 lbs.	11
7'	TSPT-247	<b>3565</b>	TSPT-307	<b>3900</b>	130 lbs.	13
8'	TSPT-248	<b>3930</b>	TSPT-308	<b>4076</b>	141 lbs.	15
9'	TSPT-249	<b>4154</b>	TSPT-309	<b>4381</b>	180 lbs.	17
10'	TSPT-2410	<b>4492</b>	TSPT-3010	<b>4612</b>	201 lbs.	19

### With Undershef



Length	24" WIDE	Price	30" WIDE	Price	Wt.	Cu. Ft.
4'	SPT-244	<b>\$2344</b>	SPT-304	<b>\$2506</b>	89 lbs.	8
5'	SPT-245	<b>2549</b>	SPT-305	<b>2717</b>	102 lbs.	9
6'	SPT-246	<b>3325</b>	SPT-306	<b>3562</b>	125 lbs.	11
7'	SPT-247	<b>3716</b>	SPT-307	<b>4039</b>	141 lbs.	13
8'	SPT-248	<b>4070</b>	SPT-308	<b>4387</b>	168 lbs.	15
9'	SPT-249	<b>4308</b>	SPT-309	<b>4535</b>	196 lbs.	16
10'	SPT-2410	<b>4644</b>	SPT-3010	<b>4767</b>	230 lbs.	17

### 6" BACKSPLASH Tubular Base



Length	24" WIDE	Price	30" WIDE	Price	Wt.	Cu. Ft.
4'	TSPS-244	<b>\$2195</b>	TSPS-304	<b>\$2344</b>	87 lbs.	12
5'	TSPS-245	<b>2420</b>	TSPS-305	<b>2585</b>	101 lbs.	15
6'	TSPS-246	<b>3226</b>	TSPS-306	<b>3449</b>	131 lbs.	18
7'	TSPS-247	<b>3699</b>	TSPS-307	<b>4007</b>	145 lbs.	21
8'	TSPS-248	<b>4034</b>	TSPS-308	<b>4335</b>	160 lbs.	24
9'	TSPS-249	<b>4263</b>	TSPS-309	<b>4550</b>	210 lbs.	16
10'	TSPS-2410	<b>4527</b>	TSPS-3010	<b>4655</b>	235 lbs.	17

### With Undershef



Length	24" WIDE	Price	30" WIDE	Price	Wt.	Cu. Ft.
4'	SPS-244	<b>\$2493</b>	SPS-304	<b>\$2657</b>	99 lbs.	12
5'	SPS-245	<b>2834</b>	SPS-305	<b>2895</b>	113 lbs.	15
6'	SPS-246	<b>3672</b>	SPS-306	<b>3748</b>	143 lbs.	18
7'	SPS-247	<b>4167</b>	SPS-307	<b>4309</b>	167 lbs.	21
8'	SPS-248	<b>4508</b>	SPS-308	<b>4586</b>	175 lbs.	24
9'	SPS-249	<b>4578</b>	SPS-309	<b>4852</b>	225 lbs.	25
10'	SPS-2410	<b>4833</b>	SPS-3010	<b>4963</b>	242 lbs.	28

## ACCESSORIES

TA-41	Replacement Poly-Vance 5/8" Cutting Board	<b>\$131</b> /sq. ft.
TA-63	Removable Shelving (In Addition To Standard Shelf)	<b>552</b> /table
TA-82	Scrap Chute	<b>350</b> ea.
SHD-2020	Enclosed Drawers - See Page 66 For Details	<b>1541</b> ea.



TA-84C Shown

### KNIFE RACKS

TA-84A	Rolled Rim Type	<b>\$512</b>
TA-84B	Poly Table Type	<b>512</b>
TA-84C	Square Edge Type	<b>512</b>



17 Years in a Row!

# TABLE MODS

## Smart Table Modifications

### TOP MODIFICATIONS



**TA-56**  
5" NSF Partition



**TA-523**  
Drop-In Urn Trough



**CDR-5**  
Condiment Holder

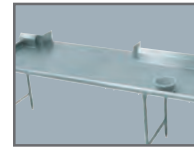

**TA-84**  
Pass-Thru



**TA-108**  
Grommet For Cords

<b>CDR-5</b>	Condiment Holder (Accommodates 5 Bins)	<b>\$1150</b>
<b>TA-1</b>	Notch Backsplash For Roll Up Door w/ Pass-Thru	<b>208</b>
<b>TA-3</b>	Stainless Steel Hat Channel & Gusset Upgrade	<b>79 /lin. ft.</b>
<b>TA-7</b>	10" Partial Splash	<b>111 /lin. ft.</b>
<b>TA-8</b>	Column Notch in Rear Splash (Includes Splash)	<b>1015 ea.</b>
<b>TA-10</b>	5" Partial Splash	<b>94 /lin. ft.</b>
<b>TA-12</b>	Countertop Edge	<b>934 /table</b>
<b>TA-22</b>	Square Edge Table	<b>N/C</b>
<b>TA-28</b>	Cut-Out For Cold Well. Incudes Louvered Doors	<b>2158 /cut out</b>
<b>TA-29</b>	16 Ga. 304 Rear Splash Capping Strip with Adhesive Backing	<b>92 /lin. ft.</b>
<b>TA-30</b>	1-1/2" Side Splash	<b>130 ea.</b>
<b>TA-30A</b>	1-1/2" Turn Up For Table Tops	<b>59 /lin. ft.</b>
<b>TA-31</b>	5" Side Splash	<b>242 ea.</b>
<b>TA-32</b>	10" Side Splash	<b>474 ea.</b>
<b>TA-34</b>	Top Cut-Out for Drop-In Style Units	<b>355 /cut out</b>
<b>TA-34A</b>	Top Cut-Out for Undermount Well	<b>596 /cut out</b>
<b>TA-35</b>	Splash Cut-Out	<b>257 /cut out</b>
<b>TA-41</b>	Poly-Vance 5/8" Cutting Board	<b>131 /sq. ft.</b>
<b>TA-56</b>	5" NSF Partition	<b>650</b>
<b>TA-56A</b>	18" NSF Partition	<b>936</b>
<b>TA-57</b>	Prepare Welded Field Joint (Welded in field by others)	<b>359 ea.</b>
<b>TA-57A</b>	Bolted Field Joint (Bolted in field by others)	<b>759 ea.</b>
<b>TA-57B</b>	Hairline Bolted Field Joint	<b>1016 ea.</b>
<b>TA-58</b>	Stepdown to 24" Working Height	<b>1603 ea.</b>
<b>TA-64</b>	Urn Trough (Factory installation only)	<b>218 /lin. ft.</b>
<b>TA-75</b>	Mitered Edge	<b>1040 ea.</b>
<b>TA-76</b>	Paint on Sound Deadening	<b>746 /table</b>
<b>TA-79</b>	Flour Trough (Factory installation only)	<b>274 /lin. ft.</b>
<b>TA-82</b>	Scrap Chute (6" dia. opening)	<b>350</b>
<b>TA-84</b>	Simple Pass-Thru	<b>921 /lin. ft.</b>
<b>TA-87</b>	Enclosed Rear Splash	<b>130 /lin. ft.</b>
<b>TA-91</b>	Poly Retaining Clips Includes TA-22 (S/S top table)	<b>644 /table</b>

<b>TA-93</b>	Wall Brackets (Includes 2. For 5" & 10 1/2" splash only)	<b>111 /table</b>
<b>TA-96A</b>	Can Opener Provision for Openers with Bolt-on Base (Customer to provide location)	<b>\$309 ea.</b>
<b>TA-96B</b>	Can Opener Surface Mount Provision with 4" S/S Tube for Openers w/o Base (Customer to provide location)	<b>774 ea.</b>
<b>TA-96C</b>	Can Opener Spacer Plate Provision for Use on Tables With Countertop Edge & Can Opener Base (Customer to provide location)	<b>479 ea.</b>
<b>TA-100</b>	Bull Nose All Sides of Worktable	<b>N/C</b>
<b>TA-101</b>	Rear Tray Lock	<b>130 /lin. ft.</b>
<b>TA-106</b>	Mirror HI-LITE Edge	<b>581 /table</b>
<b>TA-107</b>	Vacuum Breaker Holes on Tables (Includes Backsplash with 2" Return)	<b>531</b>
<b>TA-108</b>	2" Hole with Grommet for Appliance Cord	<b>191 ea.</b>
<b>TA-112</b>	Hubble Outlet	<b>825 ea.</b>
<b>TA-113</b>	Notch Top for Buyout Unit	<b>1192 ea.</b>
<b>TA-366A</b>	Heavy Duty Understructure Top	<b>466 /table</b>
<b>TA-502</b>	Install Advance Tabco Drop-In Hand Sinks or Hot Food Unit In Work Table Top (Hot Food Unit Requires TA-34 Top Cut-Out & TA-27 Control Panel. Does not include wiring. Consult factory)	<b>773 ea.</b>
<b>TA-503</b>	Install Advance Tabco 7-PS-42/7-PS-43 Hand Sinks for Countertops (Includes Cut-Out)	<b>613 ea.</b>
<b>TA-521</b>	Drop-In urn Trough 1'	<b>216 ea.</b>
<b>TA-522</b>	Drop-In urn Trough 2'	<b>430 ea.</b>
<b>TA-523</b>	Drop-In urn Trough 3'	<b>647 ea.</b>
<b>TA-524</b>	Drop-In urn Trough 4'	<b>864 ea.</b>
<b>TA-525</b>	Drop-In urn Trough 5'	<b>892 ea.</b>
<b>TA-526</b>	Drop-In urn Trough 6'	<b>944 ea.</b>
<b>TA-527</b>	Drop-In urn Trough 7'	<b>1000 ea.</b>
<b>TA-528</b>	Drop-In urn Trough 8'	<b>1029 ea.</b>
<b>TA-529</b>	Drop-In urn Trough 9'	<b>1091 ea.</b>
<b>TA-550</b>	Install Customer Supplied Buyout Items (Does not include wiring. Consult factory)	<b>Call for Price</b>
<b>TA-551</b>	Installation of Customer Supplied Hot Food Wells. (Requires TA-34 Top Cut-Out & TA-27 Control Panel. Does not include wiring. Consult factory)	<b>1152 ea.</b>

Email in your specifications to [smartfab@advancetabco.com](mailto:smartfab@advancetabco.com)

# TABLE MODS

Call For Installation of Buyout Equipment!

## Smart Table Modifications

### BASE MODIFICATIONS

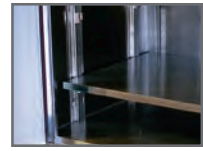
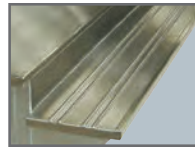
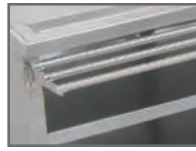

TA-39 Louvered Hinged Doors		TA-73 Drop-Down Tray Slide		TA-74 Solid Tray Slide		TA-46 Door Lock		TA-116 Adj. Mid-Shelf	
TA-4	Removable Access Panel					TA-46	Door Lock		\$451 ea.
TA-4A	Louvered Panel					TA-48	12"x12" Cut-Out in Back Panel/Undershelf for Plumbing		337
TA-5	Curb Mounting Provision					TA-54	Removable Kick Plate		216 /lin. ft.
TA-15	Provision for Built In Drawer Warmer					TA-55	Remove Back Panel (on Enclosed Base)		N/C
TA-23	Legs Welded to Undershelf or Cross-Rails, Shipped Set Up & Crated.					TA-63	Removable Shelving (In addition to standard shelf & table width)		552 /table.
TA-23A	Table Legs Welded To Leg Gussets & Undershelf or Cross-Bracing, Shipped Set Up & Crated.					TA-70	S/S Tubular Tray Divider (12" sections)		1029 ea.
TA-24	Shell Crating					TA-73	Tubular Tray Slide w/Dropdown (Stationary Tray Slide Available. Factory installation only)		374 /lin. ft.
TA-27	Control Panel (Must add TA-34A)					TA-74	Solid Tray Slide		514 /lin. ft.
TA-36-HINGED	Hinged 30" Stainless Steel Door					TA-92	12" Apron (in front of sink)		237 /lin. ft.
TA-36-SLIDING	Sliding 30" Stainless Steel Door					TA-92A	17" Stainless Steel Apron to Cover Sink Bowls and Support Lever Drain Handles		355 /lin. ft.
TA-36B	1/2 Height Stainless Steel Hinge Doors					TA-116	Adjustable Enclosed Base Cabinet Mid Shelf- Add to Price of Enclosed Base Table with Fixed Mid Shelf (M) on Page 50 or 51. Shelves Over 36" In Length Require Multiple Sections With Center Partition. For Partial Shelves Add To Price Of Shelf On Page 68.		1174 ea.
TA-36C	Hinged door with Trash Flap					TA-130	Cutlery Dispenser Holder (Undercounter Mounted)		316 /lin. ft.
TA-37	Stainless Enclosed Base					TA-135	Plate Shelf (Undercounter Mounted)		377 /lin. ft.
TA-39	24" Louvered Hinged Doors					TA-205	Connect Cafeteria Items (Per Joint Between 2 Tables. Requires Casters)		752 /set
TA-40	Remove Undershelf in Cabinet Base For Slide in Buyout								
TA-42-24	Interior Partition (2.5"x24")								
TA-42-30	Interior Partition (2.5"x30")								
TA-42-36	Interior Partition (2.5"x36")								
TA-43	Filler Panel (3"x30" with Flanged Feet)								
TA-44	K.D. Aluminum Pan Rack Slides (6 slides. Table min. lgth. 30")								
TA-45	K.D. Aluminum Glass Rack Slides (3 slides. Table min. lgth. 3 feet)								

### ELECTRICAL & DATA PORT OUTLETS



TA-62 Duplex Outlet



TA-62A GFI Duplex Outlet



TA-62D GFI Doghouse Outlet



TA-62F Empty Junction Box



TA-112 Hubble Outlet

TA-62A	GFI Duplex Outlet & Cover Plate in a VKS or KSS (1" Deep) Splash. NEMA 5-20R	\$551 ea.	TA-62E	Upgrade Outlet to a NEMA 6-20R or Equiv.	\$422 ea.
TA-62C	GFI Duplex Outlet & Cover Plate Below Shelf Top. NEMA 5-20R	600 ea.	TA-62F	Junction Box (empty) Below Table Top. Includes 1 Gang Size, Stainless Steel Face Plate	290 ea.
TA-62D	GFI Duplex Outlet & Cover Plate in a Doghouse. NEMA 5-20R	637 ea.	TA-112	Hubble Outlet	774 ea.
			TA-622	CAT-6 Data Port Connection Provided (unless otherwise specified. Cable Not Included)	570 ea.

Email in your specifications to [smartfab@advancetabco.com](mailto:smartfab@advancetabco.com)



# MORE TABLE MODS

## Smart Table Modifications

### OVERSHELF & POT RACK MODIFICATIONS

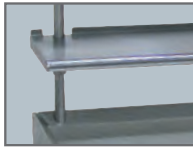

**TA-9A**  
1" Turn Up



**TA-22A**  
Square Edge



**TA-71**  
Heat Lamp Mounting Provision



**TA-100A**  
Bull Nose

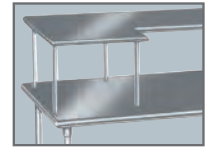

**TA-102**  
24" x 24" Extension

<b>TA-9A</b>	Partial 1" Turn-Up for all Table Mt. Shelves	<b>\$62 /lin. ft.</b>
<b>TA-22A</b>	Square Edge on Overshelf	<b>144</b>
<b>TA-26-10</b>	Welded Wall Shelf Brackets for 10" Wide Shelf	<b>358 /shelf</b>
<b>TA-26-12</b>	Welded Wall Shelf Brackets for 12" Wide Shelf	<b>358 /shelf</b>
<b>TA-26-15</b>	Welded Wall Shelf Brackets for 15" Wide Shelf	<b>358 /shelf</b>
<b>TA-26-18</b>	Welded Wall Shelf Brackets for 18" Wide Shelf	<b>358 /shelf</b>
<b>TA-47</b>	Shelf Mounting Bracket for Existing Table	<b>131 /shelf</b>
<b>TA-49</b>	Wall Shelf 2" Offset	<b>253 /shelf</b>
<b>TA-60</b>	Special Sizing Charge for Shelves (Must Order Larger Unit to be Cut Down to Smaller Size)	<b>N/C</b>
<b>TA-71</b>	Heat Lamp Mounting Provision (Heat Lamp Installed By Others)	<b>228 ea.</b>
<b>TA-71A</b>	Heat Lamp Remote Control Bracket	<b>448 ea.</b>
<b>TA-78</b>	Additional Lin. Ft. Past 12' For Table Mt. Shelf (For ODS, OTS, TS, DS & WS Shelving only)	<b>253 /lin. ft.</b>
<b>TA-77</b>	Check Minder Shelf Provision (Factory install only)	<b>81 /lin. ft.</b>
<b>TA-83</b>	Spice Bins	<b>329 ea.</b>

<b>TA-84A</b>	Knife Rack for Rolled Rim Tables	<b>\$512 ea.</b>
<b>TA-84B</b>	Knife Rack for Poly Top Tables	<b>512 ea.</b>
<b>TA-84C</b>	Knife Rack for Square Edge Tables	<b>512 ea.</b>
<b>TA-86</b>	Stainless Steel Pot Hooks	<b>34 ea.</b>
<b>TA-89</b>	Double Sided Plated Pot Hooks (Package of 4)	<b>91 /pack</b>
<b>TA-89A</b>	Single Sided Plated Pot Hooks (Package of 4)	<b>84 /pack</b>
<b>TA-98</b>	Stainless Steel Flat Bar in lieu of Chain	<b>414 ea.</b>
<b>TA-99</b>	16 Ga. S/S 304 Upgrade for Wall & Over Shelves	<b>35 /lin. ft.</b>
<b>TA-100A</b>	Bull Nose All Sides of Shelf	<b>144</b>
<b>TA-100R</b>	Bull Nose Three Sides of Shelf w/ Rear Turn Up	<b>165</b>
<b>TA-102</b>	24" x 24" Extension for Microwave or Computer Shelf (Add to OTS and ODS Shelves. See page 68)	<b>595 ea.</b>
<b>TA-103</b>	24" Wide PT Shelf (36" Min Length. Mid mt only. See Pg. 73. Add to 18" Wide Shelf)	<b>177 /lin. ft.</b>
<b>TA-104</b>	Additional Length Over 12' (Add to 18" Shelf. (PA & CU Shelving Only. Max. Length is 14' as Single Piece)	<b>383 /lin. ft.</b>

### UNDERSHELF MODIFICATIONS

<b>TA-9</b>	1-1/2" Turn-Up for Undershelves	<b>\$59 /lin. ft.</b>
<b>TA-17</b>	Upgrade Undershelf to a Marine Edge (Must add TA-23)	<b>644 ea.</b>
<b>TA-48</b>	12"x12" Cut-Out in Back Panel/Undershelf for Plumbing	<b>337</b>

<b>TA-94</b>	Upgrade 16 Ga. 304 S/S Undershelf	<b>\$75 /lin. ft.</b>
<b>TA-94A</b>	Upgrade 14 Ga. 304 S/S Undershelf	<b>95 /lin. ft.</b>
<b>TA-366</b>	Reinforced Understructure For Undershelves	<b>466 /table</b>

### SIZE MODIFICATIONS

<b>TA-33</b>	Special Working Height	<b>\$141</b>
<b>TA-33C</b>	Special Working Height For Enclosed Base Tables Up To 39" (For Heights Over 39", Contact Factory).	<b>355 ea.</b>
<b>TA-59</b>	36" Wide Equipment Stand	<b>407 ea.</b>
<b>TA-6</b>	Extra Length for Standard Tables Over 12' (Tables Over 14' Require Field Joint TA-57)	<b>537 /lin. ft.</b>
<b>TA-61</b>	Special Sizing Charge (Larger Unit Cut Down to Smaller Size)	<b>N/C</b>

<b>TA-61A</b>	Special Modification Charge	<b>\$355</b>
<b>TA-65</b>	Enclosed Base Units Over 12' (Open Base Table)	<b>697 /lin. ft.</b>
<b>TA-66</b>	Enclosed Base Units Over 12' (Sliding Door Units)	<b>1015 /lin. ft.</b>
<b>TA-67</b>	Enclosed Base Units Over 12' (Hinged Door Units)	<b>1076 /lin. ft.</b>
<b>TA-105</b>	Modify Enclosed Base Table w/ Drawers to 24" Width	<b>428 /table</b>
<b>TA-110</b>	Modify Enclosed Base Table w/ Drawers to 36" Width	<b>80 /lin. ft.</b>

### LEG MODIFICATIONS

<b>TA-16</b>	Galvanized Leg w/ Plastic Bullet Foot (34 1/2" Total Length)	<b>\$85 ea.</b>
<b>TA-16-4</b>	Galvanized Legs w/ Plastic Bullet Feet (34 1/2" Total Length)	<b>341 set/4</b>
<b>TA-16-6</b>	Galvanized Legs w/ Plastic Bullet Feet (34 1/2" Total Length)	<b>510 set/6</b>
<b>TA-19</b>	Flanged Stainless Steel Bullet Foot (34 1/2" Total Length)	<b>81 ea.</b>
<b>TA-19L</b>	Flanged S/S Bullet Foot For Enclosed Base Table	<b>111 ea.</b>
<b>TA-20</b>	Stainless Steel Leg w/ S/S Bullet Foot (34 1/2" Total Length)	<b>99 ea.</b>
<b>TA-20-4</b>	Stainless Steel Legs w/ S/S Bullet Feet (34 1/2" Total Length)	<b>392 set/4</b>

<b>TA-20-6</b>	Stainless Steel Legs w/ S/S Bullet Feet (34 1/2" Total Length)	<b>\$590 set/6</b>
<b>TA-21</b>	Stainless Steel Bullet Foot	<b>39 ea.</b>
<b>TA-68</b>	Relocate rear cross rail to center (for chairs/stools on both sides of table. For Open Base Tables Only)	<b>154 ea.</b>
<b>TA-72</b>	Leg to Wall Brace (Set per table)	<b>435 /table</b>
<b>TA-95</b>	Upgrade 16 Ga. 304 S/S Legs Only	<b>185 /table</b>

# TABLE ACCESSORIES

## Smart Table Accessories

Faucets Included Meet  
Federal Lead Free Standards



## COUNTERTOP INSTALLED HAND SINKS

- 4" Side Splashes
- K-52 Lead Free Compliant Deck Mounted Faucet
- Undermount Towel Dispenser
- 3-1/2" Basket Drain



### 7-PS-42 \$3908

Bowl Size: 10" x 14" x 5"  
Overall Size: 18-1/4" x 17-5/8"  
30 lbs. 2 cu. ft. 20 gauge

- 4" Side Splashes
- Deck Mounted Lead Free Compliant Gooseneck Spout
- Undermount Towel Dispenser
- Knee Operated Valve
- 3-1/2" Basket Drain



### 7-PS-42A \$3908

Bowl Size: 9" x 9" x 5"  
Overall Size: 17-5/8" x 13"  
30 lbs. 2 cu. ft. 20 gauge

### 7-PS-43 \$4524

Bowl Size: 10" x 14" x 5"  
Overall Size: 18-1/4" x 17-5/8"  
36 lbs. 2 cu. ft. 20 gauge



7-PS-43 Shown in Table

For Factory Installation Add TA-503 \$613  
Can Be Purchased Separately For In-Field Installation

## DROP-IN HAND SINKS & WATER STATIONS

For Custom Cut-Out Add TA-34 \$323 For Factory Installation Add TA-502 \$703

**IMPROVED!**  
Stronger Actuator



### DI-1-5SP \$2159

#### 6" Tapered Side Splash

Splash on Rear and Both Sides  
**10" x 14" x 5" Bowl**  
Overall: 13" x 19"  
Cut-out: 12 1/4" x 18 1/4"  
16 lbs. 2 cu. ft. 20 gauge



### DI-1-10SP \$2319

#### 6" Tapered Side Splash

Splash on Rear and Both Sides  
**10" x 14" x 10" Bowl**  
Overall: 13" x 19"  
Cut-out: 12 1/4" x 18 1/4"  
18 lbs. 2 cu. ft. 20 gauge



### DI-1-9 \$1466

Removable Electro-Polished  
Stainless Steel Grill  
1 1/2" IPS Basket Drain  
Overall: 12" x 14"  
Cut-Out Size: 11 1/4" x 13 1/4"  
15 lbs. 3 cu. Ft.

## Water Stations with Ice Bins

Includes K-54 8-1/4" Filler Faucet With "Push-Back" Acrylic Lever Arm (Excludes D-24-SIBL)

**IMPROVED!**  
Stronger Actuator



Ice Bin Inside Dim.:  
8" x 13 1/2" x 10 13/16"  
Ice Capacity: 23 lbs.

### D-24-WSIBL \$1969

Removable Grate Covers Drip Pan  
13" Deep Insulated Ice Bin w/ S/S Steel Cover  
1" IPS Drain  
Outside Dim. 21" x 18"  
Cut-Out Size: 20 5/8" x 15 1/4"  
30 lbs. 5 cu. Ft.

**IMPROVED!**  
Stronger Actuator



Ice Bin Inside Dim.:  
13 1/2" x 18 3/4" x 10 13/16"  
Ice Capacity: 50 lbs.

### D-24-WSIBL2 \$2355

Removable Grate Covers Drip Pan  
13" Deep Insulated Ice Bin w/ S/S Steel Cover  
1" IPS Drain  
Outside Dim.: 18" x 21"  
Cut-Out Size: 15 1/4" x 20 5/8"  
47 lbs. 5 cu. Ft.

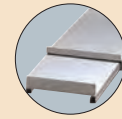

Includes Sliding  
Stainless Steel Cover



### D-24-SIBL \$2104

K-51 Deck Mounted Faucet  
Insulated Ice Bin w/ S/S Cover  
1" IPS Drain In Ice Bin  
Outside Dim.: 21" x 18"  
Cut-Out Size: 20 5/8" x 15 1/4"  
Factory Installed Only  
20 Gauge Galvanized Steel  
30 lbs. 5 cu. Ft.

Hand Sink Size:  
9 1/2" x 11 1/2" x 6"

Ice Bin Inside Dim.:  
8" x 13 1/2" x 10 13/16"

Ice Capacity: 23 lbs.

Upgrade to a 12" Filler Faucet

Use K-54OMIT, Deduct -\$420 and Add K-54A \$845

(K-54OMIT MUST be ordered with K-54A to receive upgrade)



# INTEGRAL SINKS

## Integral Sinks

### WELDED SINKS INTO TABLE TOP

Includes Lead Free Compliant Faucet & K-6 Basket Drain(s)



#### Flat Top, 1", 1-1/2" & 5 Backsplash Include Deck Mount Faucet

- **Single Sink Bowl** provided with K-50 Swing Spout Faucet
- **Double Sink Bowls** provided with K-53 Swing Spout Faucet

#### 10" Backsplash Include Splash Mount Faucet

- **Single & Double Sink Bowls** provided with K-1 Swing Spout Faucet
- Splash Mount Faucet Available On 5" Backsplash** - Add TA-11Z \$62/lin. ft.



Flat Top  
w/ K-50  
Deck Mount  
Faucet Shown



10" Backsplash  
w/ K-1  
Splash Mount  
Faucet Shown

Size		Single Bowl		Double Bowl	
A	B	Model#	Price	Model#	Price
10"	14" x 5"	TA-11Q	\$1595	TA-11Q-2 <sup>†</sup>	\$2914
10"	14" x 10"	TA-11F	1717	TA-11F-2 <sup>†</sup>	3285
14"	16" x 12"	TA-11J	1807	TA-11J-2	3380
16"	20" x 8"	TA-11A**	1795	TA-11A-2**	3340
16"	20" x 12"	TA-11B**	2005	TA-11B-2**	3686
16"	20" x 14"	TA-11V**	2333	TA-11V-2**	3957
16"	24" x 14"	TA-11K**	2341	TA-11K-2**	3966
18"	18" x 14"	TA-11N	2046	TA-11N-2	3692
18"	24" x 14"	TA-11L	2071	TA-11L-2	3722
20"	20" x 8"	TA-11C*	1895	TA-11C-2*	3665
20"	20" x 12"	TA-11D*	2157	TA-11D-2*	3879
20"	20" x 14"	TA-11W*	2259	TA-11W-2*	4144
20"	24" x 14"	TA-11P	2198	TA-11P-2	3949
20"	28" x 12"	TA-11G*	2522	TA-11G-2*	4563
20"	30" x 14"	TA-11S*	2399	TA-11S-2*	4469
24"	24" x 14"	TA-11E*	2518	TA-11E-2*	4248
24"	30" x 14"	TA-11T*	2467	TA-11T-2*	4703
24"	36" x 14"	TA-11R*	2549	TA-11R-2*	4774

\* Only Installed In Tables 30" Wide or Wider

\*\* Bowls Are Turned with 16" Front to Back on 24" Wide Tables

† K-50 Swing Spout Faucet (Double Bowl)

#### FLAT TOP, 1" or 1-1/2" REAR SPLASH

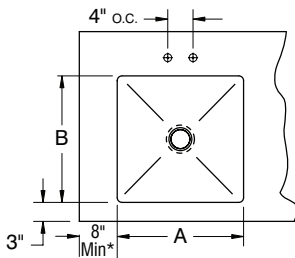

#### 5" REAR SPLASH with 1" RETURN

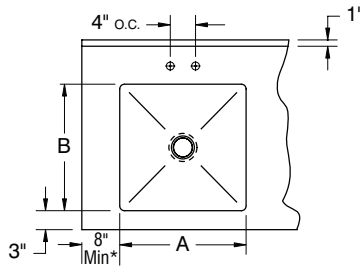

#### 10" REAR SPLASH with 2" RETURN

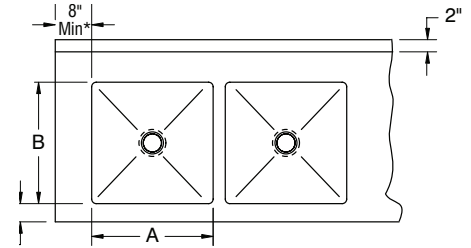

## Modifications

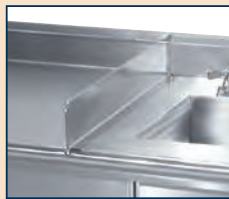

TA-56 \$650  
5" NSF Partition



TA-92 \$237  
Add 12" Apron  
In Front Of Sink



TA-11Z \$62/lin. ft.  
(Return Only)  
Modify 5" Splash To Have 2" Return  
For Splash Mounted Faucet

## Faucets & Accessories

K-2B	Poly-Vance Sink Cutting Board for 14" x 16" Bowls	\$413 ea.	K-54A	12" Water Filler Faucet	\$845
K-2C	Poly-Vance Sink Cutting Board for 16" x 20" Bowls	413 ea.	K-55	8 1/2" Spout 4" O.C. Deck Mounted Gooseneck Faucet	626
K-2D	Poly-Vance Sink Cutting Board for 18" x 24" Bowls	413 ea.	K-60	4" O.C. Splash Mounted Gooseneck Faucet	812
K-2E	Poly-Vance Sink Cutting Board for 20" x 20" Bowls	413 ea.	K-62	X.H.D. 4" O.C. Deck Mounted Gooseneck Faucet	644
K-2F	Poly-Vance Sink Cutting Board for 24" x 24" Bowls	413 ea.	K-105	14" Splash Mounted 8" O.C. Faucet	704
K-2J	Poly-Vance Sink Cutting Board for 18" x 18" Bowls	413 ea.	K-112	Extra Heavy Duty 12" Splash Mounted Faucets	674
K-4	Lever Drain Bracket	178	K-316-LU	Wrist Handles For Splash Mounted Faucets	167
K-5	Lever Drain	388	K-350	Residential Finish & Packaging	503
K-12	Deck Mounted Soap Dispenser	211	K-452	6" x 9" Control Bracket	373
K-15	Lever Drain With Overflow	688	K-453	14" x 16" Control Bracket	400
K-50	8" Deck Mounted 4" O.C. Swing Spout Faucet	377	K-460	Installation Of Disposal Cone w/ 6" x 9" Control Bracket	1115
K-50OMIT	Omit Swing Spout	-24	K-461	Installation Of Collar w/ 6" x 9" Control Bracket	1115
K-52	3 1/2" Spout Deck Mounted 4" O.C. Gooseneck Faucet	325	K-470	14" Deep Bowls	242
K-52OMIT	Omit Swing Spout Gooseneck Faucet	-24	K-472	Faucet Hole Revision	176
K-53	12" Deck Mounted 4" O.C. Swing Spout Faucet	626	DTA-100	Prerinse Basket for 20" x 20" Bowls	905
K-54	8-1/4" Water Filler Faucet	744	DTA-125	Prerinse Basket for 16" x 20" Bowls	790

**WARNING:** Equipment that includes a faucet may expose you to chemicals, including lead, that are known to the State of California to cause cancer or birth defects or other reproductive harm. For more info, visit [www.p65warnings.ca.gov](http://www.p65warnings.ca.gov).

# DRAWERS

## Integral Drawer Slides

Ship Via UPS



**PATENT PENDING**

Shown With  
3 Tier Drawer Set Up

## REVOLUTIONARY NEW SHD SERIES DRAWER WITH INTEGRAL DRAWER SLIDES

- Stainless Steel Front & Sides
- Self Closing Drawer with Noise Control
- Drawer "Safety Stop" Tab
- Removable Stainless Steel Insert
- Units Can Be Stacked to Create Multiple Tier Drawers
- Hardware Included
- NSF Approved

**Drawers Stack With Ease  
To Create Tier Drawers!  
Easily Installs In Field**

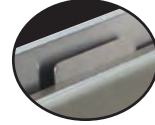

Features a  
"Safety Stop" Tab



NSF

### Insert Size

SHD-2015	20" x 15" x 5" Overall Dim. 24 5/8" x 17 1/2"	\$1443	
SHD-1520	15" x 20" x 5" Overall Dim. 17 1/2" x 24 5/8"	\$1443	
SHD-2020	20" x 20" x 5" Overall Dim. 24 5/8" x 22 11/16"	\$1541	

### Optional Concealed Side Panels FOR 20" x 20" DRAWERS (1 Needed For Each Side)

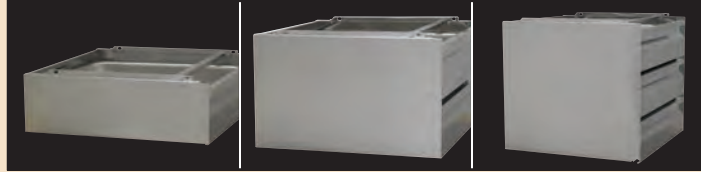

1 Drawer:  
TA-SHD-1  
\$224

2 Drawers:  
TA-SHD-2 \$282  
each side

3 Drawers:  
TA-SHD-3  
\$339

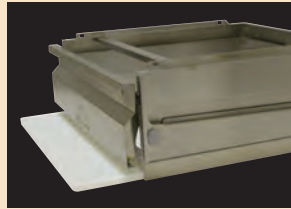

TA-97SHD \$441  
Poly Board Storage Bracket  
(Installs In Field. Hardware Included)



Rear View of Multiple Stacked  
Drawers. Seams Exposed

### SHD Series Modifications & Accessories

TA-2	Concealed Side Panel For 20" x 15" Drawer .....	\$55 ea.
(Add Additional Cost to TA-SHD-1, 2, or 3 Price)		
TA-13	Padlockable Drawer Lock .....	380
TA-14SHD	Drawer Lock For SHD Drawers .....	218
TA-97SHD	Poly Board Storage Brackets For SHD Drawers .....	441
TA-41SHD	5/8" Thick Poly Cutting Board For SHD Drawers .....	213 ea.

### DELUXE SERIES DRAWERS

- Stainless Steel Front
- Ball Bearing Slides
- Removable Insert



Insert Size	All Stainless Steel		All Stainless Steel with Keyed Lock	
	Model #	Price	Model #	Price
20" x 15" x 5"	SS-2015	\$791	SS-2015-DL	\$978
15 x 20" x 5"	SS-1520	791	SS-1520-DL	978
20 x 20" x 5"	SS-2020	856	SS-2020-DL	1045

### Deluxe and Budget Drawer Accessories

<b>Padlockable Drawer Lock</b> (Does not include lock. Fits padlocks up to 3/8" Dia. lock shaft)	
TA-13 .....	\$380
<b>Keyed Drawer Lock for SS Series Drawers</b>	
TA-14 .....	196
<b>Drawer Adapter/Non Catalog Tables</b> (specify table width)	
TA-90 .....	91
<b>Replacement Drawer Slides (For Discontinued Models FS &amp; FG Series)</b>	
TA-SL-15 .....	202
<b>Replacement Drawer Slides (SS Series)</b>	
TA-SL-20 .....	218

### CONCEALED HAND SINK DRAWER Take Back Your Countertop Space!

- Easily Installs into Existing Advance Tabco Work Tables/Countertops or Integrates into Custom Fabrication
- Overall Size: 22 5/8" W x 19 7/8" L x 19 1/4" H
- 10" x 14" x 5" Deep Sink Bowl
- Pre-Drilled Holes In Flanges For Easy Mounting
- Integral Drawer Slides For Smooth Operation
- "Safety Stop" Tab
- K-50 Swing Spout Faucet
- 1-1/2" Sink Drain with Strainer Plate
- Drainage Pan with 1-1/2" Drain & Strainer Plate (Drain Pipe & Fittings Included.)

**7-PS-47 \$3813**  
70 lbs. 7 cu. ft. 18 gauge



K-50 Faucet



Drawer  
Safety Stop Tab

NSF

All Units on this Page Feature  
SHD Series Drawers!

# DRAWERS

Integral Drawer Slides

## MOBILE DRAWER CABINETS

- Stainless Steel Top Features Countertop Edge
- 5" Swivel Plate Casters (2 with Brakes)
- Available with Three or Four Tier Drawers

Model #	Overall Size L x W x H	# Of Drawers	Drawer Size	Price
MDC-2020	25 1/4" x 25 3/4" x 29 1/2"	3	20" x 20" x 5"	<b>\$5947</b>
MDC-4-2020	25 1/4" x 25 3/4" x 29 1/2"	4	20" x 20" x 5"	<b>7242</b>
MDC-2015	25 1/4" x 21 3/4" x 29 1/2"	3	20" x 15" x 5"	<b>5753</b>
MDC-4-2015	25 1/4" x 21 3/4" x 29 1/2"	4	20" x 15" x 5"	<b>7019</b>



## FACTORY INSTALLED "SHD SERIES" TIER DRAWERS

**3 or 4 Tiers Available**  
Factory Installation Only

Model #	# Of Tiers	Inset Size	Price
TA-38	3 Tiers	20" x 20" x 5"	<b>\$5433</b>
TA-384	4 Tiers	20" x 20" x 5"	<b>6567</b>



TA-38 SHOWN

For Tier Drawers on 24" Tables,  
Add TA-380 **\$213** (Drawers will be 20" x 15" x 5")

New 4 Tier Unit Offers More Storage,  
Same Height as 3 Tier Units!

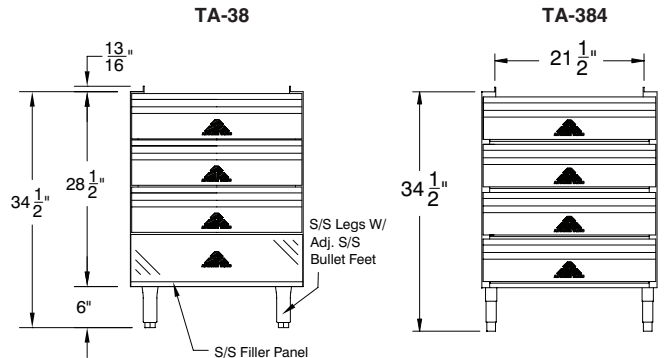

ADT-3-2020 SERIES SHOWN  
(Table Not Included)



## ADD-A-TIER DRAWERS

Fits Under 24", 30" and 36" Wide  
Open Base Work Tables!

**Features:**

- Units Come Fully Assembled!
- Includes 2 or 3 SHD-2020 Series Drawers Stacked with 2 TA-SHD Series Concealed Side Panels (See Photos).
- Hangs From Underside of Open Base Table with Included Hardware.

(See Page 60 for SHD Series Drawer Details)

Includes 2 Concealed Side Panels



2 Drawer Concealed Panel  
Model ADT-2-2020 Shown



3 Drawer Concealed Panel  
Model ADT-3-2020 Shown



Rear View of Stacked Drawers  
Drawer Seams Exposed

Model #	Overall Size L x W x H	# Of Drawers	Drawer Size	Price
ADT-2-2020	23" x 23" x 14"	2	20" x 20" x 5"	<b>\$3621</b>
ADT-3-2020	23" x 23" x 21"	3	20" x 20" x 5"	<b>5254</b>
ADT-3-2015	23" x 18" x 21"	3	20" x 15" x 5"	<b>4965</b>

# CASTERS

Casters

All Casters Ship Via UPS

## WORK TABLE CASTERS



### Standard Casters

Legs Cut To Maintains Standard 35-1/2" Working Height

200 lbs. Load Capacity Per Caster

#### When Used w/ Stainless Steel Legs

TA-25S-4 **\$594/set of 4** (Two with Brakes)

TA-25S-6 **\$897/set of 6** (Two with Brakes)

#### When Used w/ Galvanized Legs

TA-25G-4 **\$594/set of 4** (Two with Brakes)

TA-25G-6 **\$897/set of 6** (Two with Brakes)

### Casters For Special Height Tables (TA-33) and Open Base Tables (T Series)

TA-25 **\$594/set of 4**  
(Two with Brakes)

TA-25A **\$897/set of 6**  
(Two with Brakes)

200 lbs. Load Capacity Per Caster



### Single Replacement Casters

Available With Or Without Brake (Legs Not Included)

200 lbs. Load Capacity Per Caster

TA-25R **\$114 ea.**  
(No Brake)

TA-25RB **\$140 ea.**  
(With Brake)

#### Optional Standard Caster Upgrades:

TA-25B **\$284/set**

For brakes on all wheels (Standard Casters) - Add price to the following models: TA-25, TA-25A, TA-25S-4, TA-25S-6, TA-25G-4, TA-25G-6

TA-25C **\$50/Per Caster**

Upgrade Standard Caster with Heavy Duty Urethane Wheels (Per Caster)

## EQUIPMENT STAND CASTERS



### Standard Casters

5" Urethane Wheels.

Maintains the Standard 24" Working Height

200 lbs. Load Capacity Per Caster

#### w/ Stainless Steel Legs

TA-25ES **\$594/set of 4** (Two with Brakes)

#### w/ Galvanized Legs

TA-25EG **\$594/set of 4** (Two with Brakes)

### HEAVY DUTY Casters

5" Urethane Wheels

400 lbs. Load Capacity Per Caster

TA-255 **\$791** Super Heavy Duty  
Set of 4 (Two with Brakes)

TA-256 **\$1047** Super Heavy Duty  
Set of 6 (Two with Brakes)



### Enclosed Base Table Casters Easy Bolt-On Style



TA-255P **\$934** Set of 4 (Two with Brakes)

TA-255AP **\$1360** Set of 6 (Two with Brakes)

300 lbs. Load Capacity Per Caster

For brakes on all wheels (Enclosed Base Casters) -  
Add price to models: TA-255P or TA-255AP

TA-255PB **\$448**

#### Optional Equipment Stand Caster Upgrade:

TA-255B **\$387** For brakes on all wheels (Equipment Casters) - Add price to any of the following models: TA-255, TA-256, TA-25ES, TA-25EG

## MID-SHELF & UNDERSHELVES



Shelf Capacity  
20 lbs./sq. ft.



### Stainless Steel

### Galvanized

Length	24" Wide	Price	30" Wide	Price	36" Wide	Price	24" Wide	Price	30" Wide	Price	36" Wide	Price
2'	US-24-24	<b>\$473</b>	US-30-24	<b>\$535</b>	NOT AVAILABLE		UG-24-24	<b>\$270</b>	UG-30-24	<b>\$319</b>	NOT AVAILABLE	
30"	US-24-30	<b>535</b>	US-30-30	<b>590</b>	US-36-30	<b>\$677</b>	UG-24-30	<b>319</b>	UG-30-30	<b>327</b>	UG-36-30	<b>\$334</b>
3'	US-24-36	<b>557</b>	US-30-36	<b>677</b>	US-36-36	<b>814</b>	UG-24-36	<b>339</b>	UG-30-36	<b>334</b>	UG-36-36	<b>343</b>
4'	US-24-48	<b>628</b>	US-30-48	<b>763</b>	US-36-48	<b>869</b>	UG-24-48	<b>347</b>	UG-30-48	<b>356</b>	UG-36-48	<b>359</b>
5'	US-24-60	<b>727</b>	US-30-60	<b>827</b>	US-36-60	<b>979</b>	UG-24-60	<b>356</b>	UG-30-60	<b>370</b>	UG-36-60	<b>388</b>
6'	US-24-72	<b>820</b>	US-30-72	<b>941</b>	US-36-72	<b>1154</b>	UG-24-72	<b>359</b>	UG-30-72	<b>388</b>	UG-36-72	<b>397</b>
7'	US-24-84	<b>932</b>	US-30-84	<b>1010</b>	US-36-84	<b>1221</b>	UG-24-84	<b>370</b>	UG-30-84	<b>397</b>	UG-36-84	<b>413</b>
8'	US-24-96	<b>1010</b>	US-30-96	<b>1151</b>	US-36-96	<b>1329</b>	UG-24-96	<b>388</b>	UG-30-96	<b>404</b>	UG-36-96	<b>448</b>
9'	US-24-108	<b>1051</b>	US-30-108	<b>1318</b>	US-36-108	<b>1585</b>	UG-24-108	<b>404</b>	UG-30-108	<b>463</b>	UG-36-108	<b>481</b>
10'	US-24-120	<b>1107</b>	US-30-120	<b>1373</b>	US-36-120	<b>1641</b>	UG-24-120	<b>438</b>	UG-30-120	<b>494</b>	UG-36-120	<b>510</b>
11'	US-24-132	<b>1376</b>	US-30-132	<b>1621</b>	US-36-132	<b>1810</b>	UG-24-132	<b>486</b>	UG-30-132	<b>532</b>	UG-36-132	<b>550</b>
12'	US-24-144	<b>1417</b>	US-30-144	<b>1674</b>	US-36-144	<b>1910</b>	UG-24-144	<b>546</b>	UG-30-144	<b>593</b>	UG-36-144	<b>608</b>

TA-94 **\$75 lin. ft.**  
16 ga. S/S 304 Series Upgrade for any shelf

TA-9 **\$59 lin. ft.**  
1-1/2" Turn-Up for Undershelves

# Sleek Shields™

# FOOD SHIELDS

## Food Shields

## MULTI-USE FOOD SHIELDS

Protected By: U.S. Patent No. 11,129,484



**Quickly Converts From Cafeteria Style To Self-Serve Style**

### With Stainless Steel Shelf

18" Standard Shelf Height (Top of Table to Top of Shelf). 24" Wide Shelving Also Available



DSG-12S-48 Glass Positioned For Self-Serve Style

DSG-12S-48 Glass Positioned For Cafeteria Style

- Bottom front glass locks in place at 3 fixed positions
- Entire glass front rotates for easy cleaning
- Stainless Steel 1" diameter Posts.
- Includes Two 18" Wide Glass Side Panels
- 1/4" Thick Heat-Tempered Glass Side Panels
- 3/8" Thick Heat-Tempered Glass Fronts
- Stainless Steel Top Shelf (DSG "S" Series)
- 3/8" Glass Top Shelf (DSG "G" Series)

\*Requires a Single Pair of Center Legs (Factory Print Included)  
 \*\*Requires Two Pair of Center Legs (Factory Print Included)

12" WIDE	Price	Approx. Wt.	15" WIDE	Price	Approx. Wt.	18" WIDE	Price	Approx. Wt.	Approx. Cubes
DSG-12S-36	\$6403	131 lbs.	DSG-15S-36	\$7180	133 lbs.	DSG-18S-36	\$7487	136 lbs.	14
DSG-12S-48	6624	166 lbs.	DSG-15S-48	7341	169 lbs.	DSG-18S-48	7648	173 lbs.	18
DSG-12S-60	7535	191 lbs.	DSG-15S-60	7888	196 lbs.	DSG-18S-60	8194	199 lbs.	22
DSG-12S-72	7833	237 lbs.	DSG-15S-72	8287	245 lbs.	DSG-18S-72	8787	250 lbs.	26
DSG-12S-84†	8105	276 lbs.	DSG-15S-84†	8663	279 lbs.	DSG-18S-84†	8972	286 lbs.	30
DSG-12S-96†	8804	312 lbs.	DSG-15S-96†	9263	314 lbs.	DSG-18S-96†	9568	323 lbs.	34
DSG-12S-108†	9057	346 lbs.	DSG-15S-108†	9754	353 lbs.	DSG-18S-108†	10061	359 lbs.	38
DSG-12S-120†	9321	382 lbs.	DSG-15S-120†	10052	389 lbs.	DSG-18S-120†	10339	397 lbs.	42
DSG-12S-132†	9552	420 lbs.	DSG-15S-132†	10277	428 lbs.	DSG-18S-132†	10585	437 lbs.	46
DSG-12S-144††	9998	455 lbs.	DSG-15S-144††	10474	465 lbs.	DSG-18S-144††	10782	473 lbs.	50



Bottom Glass Flips All The Way Up To Become A Self-Serve Unit



Bottom Glass Can be Used As a Shelf



Easy To Use Mechanism For Changing Front Glass Positions



Entire Glass Shield Rotates For Easy Cleaning

### With 3/8" Glass Top

18" Standard Shelf Height (Top of Table to Top of Glass Shelf)



DSG-12G-72 Glass Positioned For Self-Serve Style

DSG-12G-72 Glass Positioned For Cafeteria Style

12" WIDE	Price	Approx. Wt.	15" WIDE	Price	Approx. Wt.	18" WIDE	Price	Approx. Wt.	Approx. Cubes
DSG-12G-36	\$7635	139 lbs.	DSG-15G-36	\$8472	143 lbs.	DSG-18G-36	\$9086	147 lbs.	18
DSG-12G-48	7853	179 lbs.	DSG-15G-48	8631	182 lbs.	DSG-18G-48	9248	187 lbs.	23
DSG-12G-60	8764	228 lbs.	DSG-15G-60	9178	235 lbs.	DSG-18G-60	9778	242 lbs.	29
DSG-12G-72	9066	279 lbs.	DSG-15G-72	9580	266 lbs.	DSG-18G-72	10197	275 lbs.	34
DSG-12G-84†	9342	298 lbs.	DSG-15G-84†	9955	305 lbs.	DSG-18G-84†	10568	316 lbs.	39
DSG-12G-96†	10033	330 lbs.	DSG-15G-96†	10552	346 lbs.	DSG-18G-96†	11169	357 lbs.	44
DSG-12G-108†	10287	373 lbs.	DSG-15G-108†	11045	383 lbs.	DSG-18G-108†	11660	397 lbs.	49
DSG-12G-120†	10551	412 lbs.	DSG-15G-120†	11322	424 lbs.	DSG-18G-120†	11938	439 lbs.	55
DSG-12G-132†	10782	453 lbs.	DSG-15G-132†	11570	467 lbs.	DSG-18G-132†	12185	483 lbs.	60
DSG-12G-144††	11228	495 lbs.	DSG-15G-144††	11765	511 lbs.	DSG-18G-144††	12416	528 lbs.	65

# FOOD SHIELDS

## Adjustable Food Shields

### Sleek Shields™

Protected By: Patent No. US 9,010,883 B2

### With Stainless Steel Shelf

18" Standard Shelf Height (Top of Table to Top of Shelf) • 24" Wide Shelving Also Available

#### SELF SERVE STYLE

12" WIDE	Price	Approx. Wt.	15" WIDE	Price	Approx. Wt.	18" WIDE	Price	Approx. Wt.	Approx. Cubes
NSG-12-36	\$4270	120 lbs.	NSG-15-36	\$4662	122 lbs.	NSG-18-36	\$5788	124 lbs.	18
NSG-12-48	4390	152 lbs.	NSG-15-48	4862	155 lbs.	NSG-18-48	5803	159 lbs.	23
NSG-12-60*	5356	191 lbs.	NSG-15-60*	5408	194 lbs.	NSG-18-60*	6392	198 lbs.	29
NSG-12-72*	5542	221 lbs.	NSG-15-72*	5808	228 lbs.	NSG-18-72*	6794	230 lbs.	34
NSG-12-84†	5812	254 lbs.	NSG-15-84†	6182	260 lbs.	NSG-18-84†	7167	265 lbs.	39
NSG-12-96†	6508	288 lbs.	NSG-15-96†	6779	293 lbs.	NSG-18-96†	7763	299 lbs.	44
NSG-12-108†*	6763	314 lbs.	NSG-15-108†*	7269	321 lbs.	NSG-18-108†*	8253	327 lbs.	49
NSG-12-120†*	7025	363 lbs.	NSG-15-120†*	7548	370 lbs.	NSG-18-120†*	8532	376 lbs.	55
NSG-12-132†*	7257	398 lbs.	NSG-15-132†*	7797	406 lbs.	NSG-18-132†*	8782	413 lbs.	60
NSG-12-144††	7702	422 lbs.	NSG-15-144††	7996	430 lbs.	NSG-18-144††	8980	439 lbs.	65

- †Requires a Single Pair of Center Legs (Factory Print Included)
- ††Requires Two Pair of Center Legs (Factory Print Included)
- \*3/8" Thick Heat-Tempered Glass Required For Front Glass

#### Exclusive Features Of NSG/NDSG/NSGC Sleek Shields:

- Front glass locks in place at 15° intervals
- Stainless Steel 1" diameter Posts
- Includes Two 1/4" Heat-Tempered Side Glass
- 1/4" or 3/8" Thick Heat-Tempered Glass Front Panels (See Chart For "\*" Symbol)
- Shelves have two rolled edges on front & rear and square edges on left & right sides

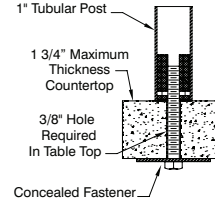

Includes Standard Concealed Mounting Hardware  
(Access To Underside Of Counter Required)

**Sleek Shields™ w/ Stainless Steel or Glass Shelf Can Be Added To All Hot/Cold Food Tables On Pages 123-131**  
See Sleek Shield Models For Food Tables  
On Page 138



#### SELF SERVE STYLE - DOUBLE TIER

12" WIDE	Price	Approx. Wt.	15" WIDE	Price	Approx. Wt.	18" WIDE	Price	Approx. Wt.	Approx. Cubes
NDSG-12-36	\$6743	155 lbs.	NDSG-15-36	\$7040	160 lbs.	NDSG-18-36	\$8026	166 lbs.	26
NDSG-12-48	7032	194 lbs.	NDSG-15-48	7238	199 lbs.	NDSG-18-48	8220	206 lbs.	34
NDSG-12-60*	7944	243 lbs.	NDSG-15-60*	7785	250 lbs.	NDSG-18-60*	8771	258 lbs.	41
NDSG-12-72*	8245	277 lbs.	NDSG-15-72*	8185	290 lbs.	NDSG-18-72*	9174	308 lbs.	49
NDSG-12-84†	8521	324 lbs.	NDSG-15-84†	8560	330 lbs.	NDSG-18-84†	9544	344 lbs.	56
NDSG-12-96†	9216	353 lbs.	NDSG-15-96†	9158	365 lbs.	NDSG-18-96†	10144	376 lbs.	64
NDSG-12-108†*	9468	399 lbs.	NDSG-15-108†*	9648	405 lbs.	NDSG-18-108†*	10628	411 lbs.	71
NDSG-12-120†*	9733	443 lbs.	NDSG-15-120†*	9929	445 lbs.	NDSG-18-120†*	10912	457 lbs.	79
NDSG-12-132†*	9963	483 lbs.	NDSG-15-132†*	10174	496 lbs.	NDSG-18-132†*	11161	503 lbs.	86
NDSG-12-144††	10090	513 lbs.	NDSG-15-144††	10372	546 lbs.	NDSG-18-144††	11490	546 lbs.	94



10-1/2" Standard Glass Opening (Maximum 13")  
From Table To Bottom Of Glass.

#### CAFETERIA STYLE

12" WIDE	Price	Approx. Wt.	15" WIDE	Price	Approx. Wt.	18" WIDE	Price	Approx. Wt.	Approx. Wt.
NSGC-12-36	\$4763	125 lbs.	NSGC-15-36	\$5541	128 lbs.	NSGC-18-36	\$5848	130 lbs.	18
NSGC-12-48	4985	160 lbs.	NSGC-15-48	5701	163 lbs.	NSGC-18-48	6008	167 lbs.	23
NSGC-12-60*	5894	185 lbs.	NSGC-15-60*	6249	190 lbs.	NSGC-18-60*	6556	193 lbs.	29
NSGC-12-72*	6193	231 lbs.	NSGC-15-72*	6650	239 lbs.	NSGC-18-72*	7147	244 lbs.	34
NSGC-12-84†	6467	270 lbs.	NSGC-15-84†	7022	274 lbs.	NSGC-18-84†	7332	281 lbs.	39
NSGC-12-96†	7164	306 lbs.	NSGC-15-96†	7624	308 lbs.	NSGC-18-96†	7927	317 lbs.	44
NSGC-12-108†*	7418	340 lbs.	NSGC-15-108†*	8113	347 lbs.	NSGC-18-108†*	8419	353 lbs.	49
NSGC-12-120†*	7680	376 lbs.	NSGC-15-120†*	8412	383 lbs.	NSGC-18-120†*	8698	391 lbs.	55
NSGC-12-132†*	7913	414 lbs.	NSGC-15-132†*	8638	422 lbs.	NSGC-18-132†*	8946	431 lbs.	60
NSGC-12-144††	8357	450 lbs.	NSGC-15-144††	8835	574 lbs.	NSGC-18-144††	9143	467 lbs.	65



1-1/2" Standard Glass Opening (Maximum 1-1/2")  
From Table To Bottom Of Glass.

**CUSTOM UNITS & SIZES AVAILABLE ON ALL FOOD SHIELDS**

Food Shield Prices May Change Due To Customer Specifications & Design



### With Glass Top

3/8" Thick Heat-Tempered Glass Top

\*Requires a Single Pair of Center Legs (Factory Print Included)  
 \*\*Requires Two Pair of Center Legs (Factory Print Included)  
 \*3/8" Thick Heat-Tempered Glass Required For Front Glass

#### Exclusive Features Of GSG/GSGC/NSGD Sleek Shields:

- Front glass locks in place at 15° intervals
- Stainless Steel 1" diameter Posts
- Includes Two 1/4" Heat-Tempered Side Glass
- 1/4" or 3/8" Thick Heat-Tempered Glass Front Panels (See Chart For "\*" Symbol)
- Glass Top Features 3/8" Heat-Tempered Glass Top

### SELF SERVE STYLE

12" WIDE	Price	Approx. Wt.	15" WIDE	Price	Approx. Wt.	18" WIDE	Price	Approx. Wt.	Approx. Cubes
GSG-12-36	\$4798	127 lbs.	GSG-15-36	\$5480	146 lbs.	GSG-18-36	\$6097	133 lbs.	18
GSG-12-48	5004	162 lbs.	GSG-15-48	5680	187 lbs.	GSG-18-48	6295	173 lbs.	23
GSG-12-60*	5930	202 lbs.	GSG-15-60*	6226	234 lbs.	GSG-18-60*	6842	216 lbs.	29
GSG-12-72†	6113	238 lbs.	GSG-15-72†	6629	274 lbs.	GSG-18-72†	7242	253 lbs.	34
GSG-12-84†	6387	274 lbs.	GSG-15-84†	7004	316 lbs.	GSG-18-84†	7619	292 lbs.	39
GSG-12-96†	7085	309 lbs.	GSG-15-96†	7559	357 lbs.	GSG-18-96†	8216	330 lbs.	44
GSG-12-108†*	7333	338 lbs.	GSG-15-108†*	8092	392 lbs.	GSG-18-108†*	8685	362 lbs.	49
GSG-12-120†*	7598	391 lbs.	GSG-15-120†*	8369	451 lbs.	GSG-18-120†*	8983	417 lbs.	55
GSG-12-132†*	7831	427 lbs.	GSG-15-132†*	8644	495 lbs.	GSG-18-132†*	9233	457 lbs.	60
GSG-12-144††	8276	455 lbs.	GSG-15-144††	8815	529 lbs.	GSG-18-144††	9431	489 lbs.	65



10-1/2" Standard Glass Opening (Maximum 13")  
 From Table To Bottom Of Glass.  
 Max. Load For Top Glass Is 100 Lbs. Even Dist. Wt.

### CAFETERIA STYLE

12" WIDE	Price	Approx. Wt.	15" WIDE	Price	Approx. Wt.	18" WIDE	Price	Approx. Wt.	Approx. Cubes
GSGC-12-36	\$5338	133 lbs.	GSGC-15-36	\$6178	137 lbs.	GSGC-18-36	\$6793	141 lbs.	18
GSGC-12-48	5555	173 lbs.	GSGC-15-48	6336	176 lbs.	GSGC-18-48	6952	182 lbs.	23
GSGC-12-60*	6467	222 lbs.	GSGC-15-60*	6883	229 lbs.	GSGC-18-60*	7482	236 lbs.	29
GSGC-12-72†	6772	274 lbs.	GSGC-15-72†	7285	260 lbs.	GSGC-18-72†	7902	269 lbs.	34
GSGC-12-84†	7046	292 lbs.	GSGC-15-84†	7659	300 lbs.	GSGC-18-84†	8273	311 lbs.	39
GSGC-12-96†	7740	330 lbs.	GSGC-15-96†	8256	340 lbs.	GSGC-18-96†	8873	351 lbs.	44
GSGC-12-108†*	7994	367 lbs.	GSGC-15-108†*	8748	377 lbs.	GSGC-18-108†*	9362	391 lbs.	49
GSGC-12-120†*	8253	406 lbs.	GSGC-15-120†*	9027	419 lbs.	GSGC-18-120†*	9642	434 lbs.	55
GSGC-12-132†*	8487	447 lbs.	GSGC-15-132†*	9274	461 lbs.	GSGC-18-132†*	9888	477 lbs.	60
GSGC-12-144††	8932	489 lbs.	GSGC-15-144††	9470	505 lbs.	GSGC-18-144††	10121	522 lbs.	65

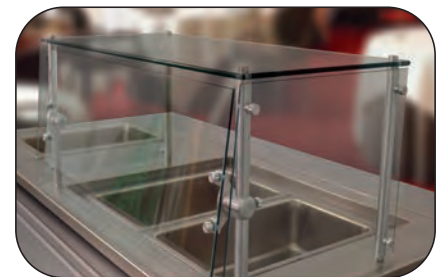

1-1/2" Standard Glass Opening (Maximum 1-1/2")  
 From Table To Bottom Of Glass.  
 Max. Load For Top Glass Is 100 Lbs. Even Dist. Wt.

### SELF SERVE STYLE - DOUBLE SIDED

w/ Stainless Steel Shelf			w/ Glass Top			
Model #	Price	Approx. Wt.	Model #	Price	Approx. Wt.	Approx. Cubes
NSGD-40-36	\$7827	339 lbs.	GSGD-40-36	\$8001	368 lbs.	32
NSGD-40-48	8037	391 lbs.	GSGD-40-48	8213	437 lbs.	42
NSGD-40-60*	8962	451 lbs.	GSGD-40-60*	9137	509 lbs.	51
NSGD-40-72†	9143	518 lbs.	GSGD-40-72†	9319	592 lbs.	61
NSGD-40-84†	9417	604 lbs.	GSGD-40-84†	9593	660 lbs.	70
NSGD-40-96†	10113	667 lbs.	GSGD-40-96†	10289	729 lbs.	79
NSGD-40-108†*	10365	725 lbs.	GSGD-40-108†*	10937	798 lbs.	89
NSGD-40-120†*	10626	782 lbs.	GSGD-40-120†*	11331	868 lbs.	98
NSGD-40-132†*	10860	840 lbs.	GSGD-40-132†*	11561	932 lbs.	107
NSGD-40-144††	11308	909 lbs.	GSGD-40-144††	11817	1001 lbs.	117



GSGD Series Shown  
 10-1/2" Standard Glass Opening (Maximum 13")  
 From Table To Bottom Of Glass.  
 Max. Load For Top Glass Is 100 Lbs. Even Dist. Wt.

**Sleek Shields™ w/ Stainless Steel or Glass Shelf Can Be Added To Hot/Cold Food Tables**  
 With 2, 3 or 4 Wells, Listed On Pages 127 - 135  
 See Sleek Shield Models For Food Tables On Page 138



# FOOD SHIELDS

## Adjustable & Fixed Front Food Shields



For Accessories & Modifications Available - See Page 73

### Sleek Shields™ SELF SERVE FOOD SHIELD

14 3/4" Standard Front Glass

Glass Clearance is 10" From Table to Bottom of Glass

Single Front Glass				Dual Front Glass (Includes Center Post)			
Model #	Price	Approx. Wt.	Approx. Cubes	Model #	Price	Approx. Wt.	Approx. Cubes
GS-36	\$5337	136	20	GS-84	\$6933	280	40
GS-48	5509	171	26	GS-96	8190	317	44
GS-60	5678	266	31	GS-120	8577	358	48
GS-66	5904	238	34	GS-132	9018	396	52
GS-72	6713	243	37	GS-144	9275	434	56



FEATURING  
CHAMBER LOCK™  
ROTATION SYSTEM  
Protected By: Patent No. US  
9,010,883 B2

- 3/8" Thick Heat-Tempered Glass Front
- 2 - 21 7/8" Wide x 22" High,  
1/4" Thick Heat-Tempered Side Glass
- 1" Stainless Steel Tubing Posts

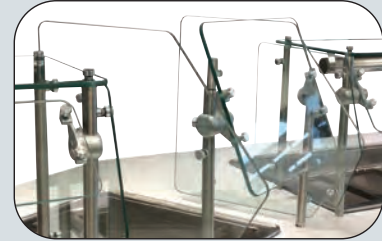

### FIXED FRONT GLASS TOP FOOD SHIELDS

Includes Front & Side Glass • 15" Wide Glass Top Also Available

- 3/8" Thick Heat-Tempered Top Glass
- 1/4" Thick Heat-Tempered Front Glass\*
- Two 1/4" Thick Heat-Tempered Glass Side Panels
- 1" Stainless Steel Round Tubing
- Includes Standard Concealed Mounting Hardware  
(Access To Underside Of Counter Required)



STFS-12-36 Series shown



STFC-12-36 Series shown

Self-Serve Style 8" Standard Front Glass Height						New Design!	Cafeteria Style 18" Standard Front Glass Height						
L	12" WIDE	Price	Wt.	18" WIDE	Price	Wt.	12" WIDE	Price	Wt.	18" WIDE	Price	Wt.	Cubes
36"	STFS-12-36	\$3331	127 lbs.	STFS-18-36	\$4630	133 lbs.	STFC-12-36	\$3871	133 lbs.	STFC-18-36	\$5326	141 lbs.	18
48"	STFS-12-48	3539	162 lbs.	STFS-18-48	4829	173 lbs.	STFC-12-48	4089	173 lbs.	STFC-18-48	5486	182 lbs.	23
60"	STFS-12-60*	4464	202 lbs.	STFS-18-60*	5376	216 lbs.	STFC-12-60*	5001	222 lbs.	STFC-18-60*	6016	236 lbs.	29
72"	STFS-12-72*	4646	238 lbs.	STFS-18-72*	5777	253 lbs.	STFC-12-72*	5305	274 lbs.	STFC-18-72*	6435	269 lbs.	34
84"	STFS-12-84†	4920	274 lbs.	STFS-18-84†	6151	292 lbs.	STFC-12-84†	5579	292 lbs.	STFC-18-84†	6807	311 lbs.	39
96"	STFS-12-96†	5619	309 lbs.	STFS-18-96†	6749	330 lbs.	STFC-12-96†	6272	330 lbs.	STFC-18-96†	7405	351 lbs.	44
108"	STFS-12-108*†	5866	338 lbs.	STFS-18-108*†	7218	362 lbs.	STFC-12-108*†	6526	367 lbs.	STFC-18-108*†	7896	391 lbs.	49
120"	STFS-12-120*†	6131	391 lbs.	STFS-18-120*†	7516	417 lbs.	STFC-12-120*†	6787	406 lbs.	STFC-18-120*†	8175	434 lbs.	55
132"	STFS-12-132*†	6365	427 lbs.	STFS-18-132*†	7768	457 lbs.	STFC-12-132*†	7019	447 lbs.	STFC-18-132*†	8421	477 lbs.	60
144"	STFS-12-144††	6809	455 lbs.	STFS-18-144††	7965	489 lbs.	STFC-12-144††	7465	489 lbs.	STFC-18-144††	8655	522 lbs.	65

\*3/8" Thick Heat-Tempered Glass Required For Front † Requires a single pair of center legs †† Requires two pair of center legs

### 45° ANGLED FIXED FRONT FOOD SHIELDS

Self-Serve Style  
w/ Angled Top & Side Glass

Model #	Price	Approx. Wt.	Approx. Cubes
AFS-36	\$4727	130 lbs.	6
AFS-48	5380	164 lbs.	8
AFS-60*	5903	207 lbs.	10



Shown With Black Powder Coating

- 1/4" Thick Heat-Tempered Front Glass
- 1/4" Thick Side Glass
- 1" Stainless Steel Tubing with End Caps
- Includes Standard Concealed Mounting Hardware  
(Access To Underside Of Counter Required)

Cafeteria Style  
w/ Angled Top, Front & Side Glass

Model #	Price	Approx. Wt.	Approx. Cubes
AFC-36	\$5594	143 lbs.	6
AFC-48	6235	178 lbs.	8
AFC-60*	6402	235 lbs.	10



### FIXED FRONT VERTICAL FOOD SHIELDS



- 24" Standard Front Glass height
- 1/4" Thick Heat-Tempered Glass
- Two 18" Wide Glass Side Panels
- 1" Stainless Steel Tubing with End Caps  
(1 5/8" Tubing Also Available)
- Includes Standard Concealed Mounting Hardware  
(Access To Underside Of Counter Required)
- NSF Requires 60" Minimum Height Above Finished Floor
- NSF Requires 6" Maximum Height From Top of Table  
to Bottom of Glass

Custom Food Shield Sizes Available

Call Our Smart Fabrication™ Department At  
800-645-3166

Model #	Price	Approx. Wt.	Approx. Cubes
SGCC-36	\$6368	139 lbs.	9
SGCC-48	7033	194 lbs.	11
SGCC-60*	7927	219 lbs.	13
SGCC-72	10038	240 lbs.	15
SGCC-84	9955	271 lbs.	17
SGCC-96	10474	311 lbs.	19
SGCC-108*	11320	357 lbs.	22
SGCC-120*	12404	412 lbs.	25
SGCC-132	13186	451 lbs.	26
SGCC-144	14130	518 lbs.	27

\*3/8" Thick Heat-Tempered Glass Required For Front

For Enclosed Base Table Options See Pages 50-51

### SLEEK SHIELDS™ ACCESSORIES & MODIFICATIONS

#### LED Display Lighting

**Factory Installed**

- Aluminum Rail with Shatter-Proof Optics
- Standard Natural Aluminum Finish. Available in White or Black
- Includes Class 2 Low Voltage Power Supply-120V-277V
- High Impact Resistant Mounting Clips



**FACTORY INSTALLED ONLY**  
Includes Installation Charge

L	S/S Shelf Mounted		Glass Top Mounted	
	Model #	Price	Model #	Price
1'	LED-S-12	<b>\$548</b>	LED-G-12	<b>\$803</b>
2'	LED-S-24	<b>660</b>	LED-G-24	<b>944</b>
3'	LED-S-36	<b>761</b>	LED-G-36	<b>1045</b>
4'	LED-S-48	<b>849</b>	LED-G-48	<b>1139</b>
5'	LED-S-60	<b>944</b>	LED-G-60	<b>1202</b>
6'	LED-S-72	<b>1076</b>	LED-G-72	<b>1331</b>

**Shelves Require 6" Clearance On Both Sides To Fit Above Led Lighting.**

**PRINT REQUIRED FOR PROPER LED LOCATION**

#### Heat Lamp Mounting Provisions

Customers To Supply Heat Lamp

**All Food Shields With Glass Tops Require Factory Installation Only**

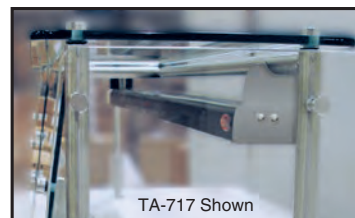

**FACTORY INSTALLED**

**TA-717 \$279 /lin. ft.**  
MINIMUM OF 3 FEET REQUIRED.  
MUST ORDER SAME LENGTH AS FOOD SHIELD.

- Welded Tubular Stainless Steel Posts
- Chase-Way for Concealing Wiring
- Pre-Wiring Available
- Print Required For Proper Installation

**INSTALLED BY OTHERS**

(Provision for mounting to Stainless Steel Shelves only)

**TA-71 \$228 ea.**

#### Revolutionary Sleek Shield™ Horizontal Swivel Bracket

- Bracket Connects Multiple Sleek Shields™ And Swivels Freely for Custom Line Up
- Easily Adjusts In Field Without Tools
- Factory Installed Only

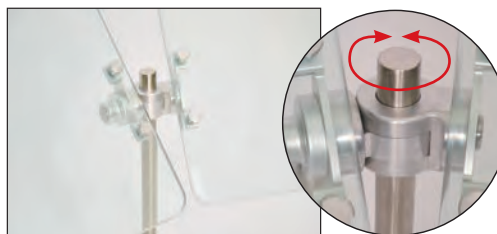

**SG-S \$1762**  
Per Section



**SG-1**

#### SURFACE MOUNTING BRACKET

(For 1" Posts)

**SG-1 \$164 ea.**

**REDUCE LENGTH OR WIDTH OF SHELF**  
Start With Next Largest Size Then Add To Model Number  
**TA-60 N/C**

#### CANTILEVER SUPPORT BRACKET UPGRADE

(Omits Front or Rear Support Leg To Equipment in Counter)

**SG-C \$609 per leg**

**SPECIAL HEIGHT FOR FOOD SHIELDS**  
Please Specify Height  
**TA-33F \$70**



**SG-PC Shown**

#### CUSTOM COLORS SG-AN Call For Pricing

Color Anodizing For Sleek Shields™ (For Aluminum Components)

#### SG-PC Call For Pricing

Powder Coating For Sleek Shields™ (For Stainless Steel Components)

### PORTABLE FOOD SHIELDS

- 15" Front Panel
- 1/4" Thick Thermoplastic Polymer Sneeze Guard
- 1" Stainless Steel Posts
- 1-1/2" Wide x 14-1/2" Front to Back Black Support Base
- Shipped K.D.

Length	Model #	Price	Approx. Wt.	Approx. Cubes
24"	PFS-24B	<b>\$2530</b>	11 lbs.	5
36"	PFS-36B	<b>2776</b>	12 lbs.	6
48"	PFS-48B	<b>3214</b>	15 lbs.	18
60"	PFS-60B	<b>3615</b>	18 lbs.	8
72"	PFS-72B	<b>3945</b>	21 lbs.	9



#### OPTIONAL 18" WIDE SIDE PANELS

18" x 20" x 1/4" Acrylic Side Panels  
Factory Installed Only

**PFS-SP \$1148 /set of 2**

Approx. 5 lbs.

# SHELVING

## Stainless Steel Shelving



Shelves Mount to Underside of Table with Single Expansion Bolt to Maximize Space

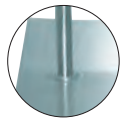

### TABLE MOUNTED ALL STAINLESS STEEL SHELVING



#### SINGLE DECK SHELVING

Ft.	12" WIDE	Price	15" WIDE <sup>†</sup>	Price	Approx. Wt.	Approx. Cubes
3'	OTS-12-36	\$1057	OTS-15-36	\$1265	24 lbs.	2
4'	OTS-12-48	1112	OTS-15-48	1372	25 lbs.	3
5'	OTS-12-60	1206	OTS-15-60	1548	31 lbs.	3
6'	OTS-12-72	1284	OTS-15-72	1712	37 lbs.	4
7'	OTS-12-84	1372	OTS-15-84	1791	43 lbs.	5
8'	OTS-12-96*	1657	OTS-15-96*	1929	50 lbs.	5
9'	OTS-12-108*	1760	OTS-15-108*	2297	59 lbs.	6
10'	OTS-12-120*	1807	OTS-15-120*	2353	68 lbs.	7
11'	OTS-12-132*	1901	OTS-15-132*	2638	82 lbs.	7
12'	OTS-12-144*	1958	OTS-15-144*	2697	98 lbs.	8

\* SHELVES 8' OR LONGER INCLUDE CENTER LEG SUPPORT

Check It Out  
Post Height can be customized!  
Use TA-33A \$70

#### DOUBLE DECK SHELVING

12" WIDE	Price	15" WIDE <sup>†</sup>	Price	Approx. Wt.	Approx. Cubes
ODS-12-36	\$2105	ODS-15-36	\$2277	24 lbs.	4
ODS-12-48	2165	ODS-15-48	2452	29 lbs.	5
ODS-12-60	2308	ODS-15-60	2751	35 lbs.	6
ODS-12-72	2461	ODS-15-72	3017	40 lbs.	7
ODS-12-84	2636	ODS-15-84	3273	46 lbs.	8
ODS-12-96*	3143	ODS-15-96*	3661	55 lbs.	10
ODS-12-108*	3385	ODS-15-108*	3983	60 lbs.	11
ODS-12-120*	3443	ODS-15-120*	4144	66 lbs.	12
ODS-12-132*	3676	ODS-15-132*	4369	72 lbs.	13
ODS-12-144*	3733	ODS-15-144*	4563	78 lbs.	14

\*8' or longer includes center leg support

For 1" Rear Turn Up, add "R" after model # (Example: OTS-12-60R) • †15" Wide Shelving has 1-5/8" Tubing

For 10" Wide Shelving – Use 12" Models & Price. Replace "12" with "10" (Example: ODS-10-36)

### TABLE MOUNTED FULLY ADJUSTABLE SHELVING WITH 14" OR 30" CHROME POSTS

#### SINGLE DECK SHELVING

Ft.	12" WIDE	Price	Approx. Wt.	Approx. Cubes
3'	TS-12-36	\$990	13 lbs.	2
4'	TS-12-48	1051	15 lbs.	3
5'	TS-12-60	1123	17 lbs.	3
6'	TS-12-72	1200	20 lbs.	4
7'	TS-12-84	1282	23 lbs.	5
8'	TS-12-96*	1563	28 lbs.	5
9'	TS-12-108*	1662	30 lbs.	6
10'	TS-12-120*	1717	33 lbs.	7
11'	TS-12-132*	1818	36 lbs.	7
12'	TS-12-144*	1878	39 lbs.	8

#### DOUBLE DECK SHELVING

Ft.	12" WIDE	Price	Approx. Wt.	Approx. Cubes
3'	DS-12-36	\$1953	24 lbs.	4
4'	DS-12-48	2012	29 lbs.	5
5'	DS-12-60	2166	35 lbs.	6
6'	DS-12-72	2319	40 lbs.	7
7'	DS-12-84	2474	46 lbs.	8
8'	DS-12-96*	3000	55 lbs.	10
9'	DS-12-108*	3253	60 lbs.	11
10'	DS-12-120*	3314	66 lbs.	12
11'	DS-12-132*	3562	72 lbs.	13
12'	DS-12-144*	3615	78 lbs.	14

\*8' or longer includes center leg support

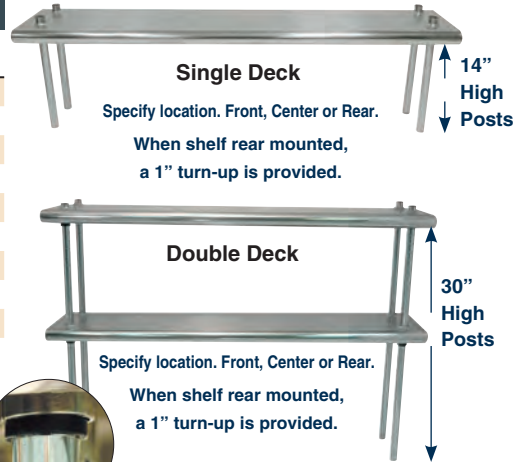

For 10" Wide Shelving  
Use 12" Models & Price.  
Replace "12" with "10" (Example: DS-10-36)

Tapered Split Sleeve Installation & Numbered Posts



For 1" Rear Turn Up, add "R" after model # (Example: TS-12-60R) • For 15" Wide Shelving (w/ 1-5/8" Tubing) Use OTS/ODS Series

### ADJUSTABLE 18" WIDE DOUBLE OVERSHELF WITH 6" OFFSET

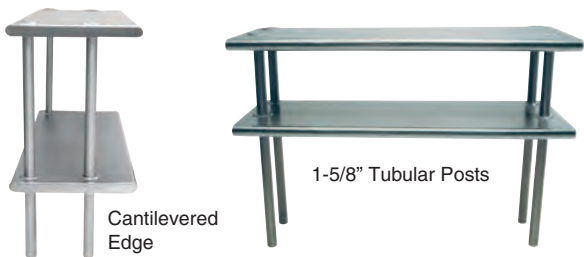

Length	Model #	Price	Approx. Wt.	Approx. Cubes
3'	CDS-18-36	\$3714	24 lbs.	4
4'	CDS-18-48	3786	29 lbs.	5
5'	CDS-18-60	4261	35 lbs.	6
6'	CDS-18-72	4353	40 lbs.	7
7'	CDS-18-84	4446	46 lbs.	8
8'	CDS-18-96	4688	55 lbs.	10
9'	CDS-18-108	4967	60 lbs.	11
10'	CDS-18-120	5044	66 lbs.	12
11'	CDS-18-132	5247	72 lbs.	13
12'	CDS-18-144	5302	78 lbs.	14

# 18" & 24" WIDE TABLE MOUNTED SHELVING



# SHELVING Specialty Shelving

## For Existing Equipment For SMART FABRICATION™ CHEF'S LINE

- Stainless Steel Shelving (1 Tier or 2 Tier Shelves)
- Stainless Steel Posts (1" Posts Available)
- Mounting Brackets Included

Customer To Specify Models Of Buyout Equipment.  
Print Required.

### Call For a Custom Quote

Quote Prints Available On Request  
- A Service Only Advance Tabco Offers!  
Call Our Estimating Department At 800-645-3166  
or email smartFab@advancetabco.com

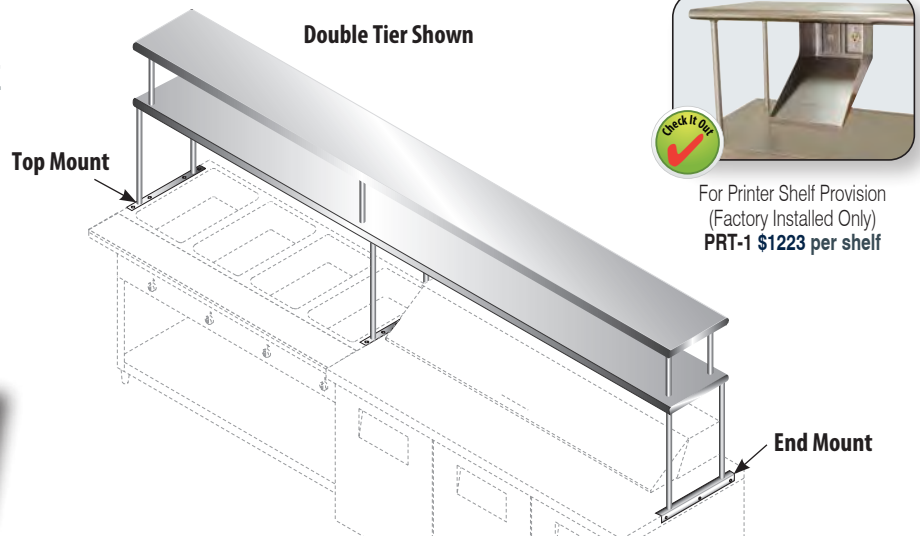

Single Tier Shelving							Double Tier Shelving						
Ft.	Approx. Cubes	18" WIDE	Approx. Price	Approx. Wt.	24" WIDE	Approx. Price	Approx. Wt.	18" WIDE	Approx. Price	Approx. Wt.	24" WIDE	Approx. Price	Approx. Wt.
4'	12	CU-18-48	\$2158	42 lbs.	CU-24-48	\$2668	55 lbs.	CU-18-48-2	\$4154	76 lbs.	CU-24-48-2	\$4569	114 lbs.
5'	15	CU-18-60	2228	53 lbs.	CU-24-60	2858	61 lbs.	CU-18-60-2	4352	95 lbs.	CU-24-60-2	4786	131 lbs.
6'	17	CU-18-72	2310	64 lbs.	CU-24-72	2983	70 lbs.	CU-18-72-2	4550	115 lbs.	CU-24-72-2	5004	152 lbs.
7'	20	CU-18-84	2617	75 lbs.	CU-24-84	3398	81 lbs.	CU-18-84-2	4938	135 lbs.	CU-24-84-2	5435	176 lbs.
8'	23	CU-18-96	2820	89 lbs.	CU-24-96	3658	98 lbs.	CU-18-96-2	5122	160 lbs.	CU-24-96-2	5634	207 lbs.
9'	26	CU-18-108	3042	95 lbs.	CU-24-108	4037	104 lbs.	CU-18-108-2	5347	121 lbs.	CU-24-108-2	5715	239 lbs.
10'	29	CU-18-120	3220	105 lbs.	CU-24-120	4344	113 lbs.	CU-18-120-2	5432	189 lbs.	CU-24-120-2	5800	283 lbs.
11'	32	CU-18-132	3396	118 lbs.	CU-24-132	4446	129 lbs.	CU-18-132-2	5431	212 lbs.	CU-24-132-2	5973	331 lbs.
12'	35	CU-18-144	3505	130 lbs.	CU-24-144	4948	146 lbs.	CU-18-144-2	5679	235 lbs.	CU-24-144-2	6249	387 lbs.

## Shelving Modifications

### Undermount Paper/Accessories Shelf

TA-117 \$386 /lin. ft.

#### Additional Fixed Partitions

(Specify Location For Factory Installation) TA-117A \$151 ea.

- 7" Wide x 12" High
- Two Adjustable Partitions To Create Separate Compartments

FACTORY INSTALLED ONLY

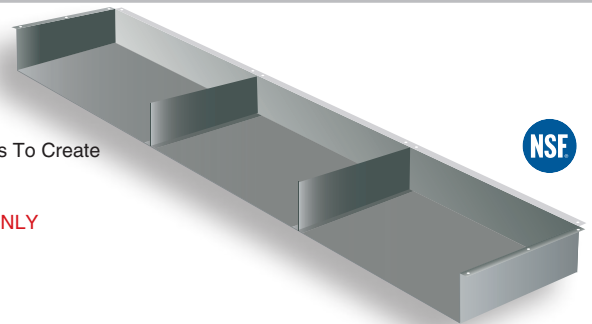

TA-9A	Partial 1" Turn-Up for all Table Mt. Shelves .....	\$62 /lin. ft.	TA-71	Heat Lamp Mounting Provision .....	\$228 ea.
TA-22A	Square Edge on Overshelf .....	144 ea.	TA-71A	Heat Lamp Remote Control Bracket.....	448 ea.
TA-26-10	Welded Wall Shelf Brackets for 10" Shelf.....	358 /shelf	TA-77	Check Minder Shelf Provision (Factory Install Only) .....	81 /lin. ft.
TA-26-12	Welded Wall Shelf Brackets for 12" Shelf.....	358 /shelf	TA-85	30" Wide CU Shelf (Add to price of 24" Shelf. For double tier, add twice) .....	288 /lin. ft.
TA-26-15	Welded Wall Shelf Brackets for 15" Shelf.....	358 /shelf	TA-99	16 Ga. S/S 304 Upgrade for Wall & Over Shelves .....	35 /lin. ft.
TA-26-18	Welded Wall Shelf Brackets for 18" Shelf.....	358 /shelf	TA-99A	14 Ga. S/S 304 Upgrade for Wall & Over Shelves .....	65 /lin. ft.
TA-33A	Customize Post Height (Specify Height) .....	70 /Shelf	TA-100A	Bull Nose Edge On all 4 Sides of Shelf .....	144 ea.
TA-47	Shelf Mounting Bracket for Existing Table .....	131 /shelf	TA-102	24" x 24" Extension for Microwave or Computer Shelf (Add to OTS and ODS Shelves. See page 45) .....	595 ea.
TA-49	Wall Shelf 2" Offset .....	253 /shelf	TA-103	24" Wide PT Shelf (36" Min Length. Mid mount only. PT Series Shelf, see pg. 48. Add to 18" Wide Shelf) .....	177 /lin. ft.
TA-60	Special Sizing Charge for Shelves (Must Order Larger Unit to be Cut Down to Smaller Size) .....	N/C	TA-104	Add'l Length Over 12' - Add to 18" or 24" Shelf (CU Shelving Only. Maximum Length is 14' as Single Piece) .....	383 /lin. ft.
TA-62C	Duplex Electrical Outlet (Under Flat Top) .....	671 ea.			
TA-62D	GFI Duplex Outlet in a Doghouse Box .....	713 ea.			

## PASS-THRU SHELVING

### Standard Pass-Thru Shelf

- "Hat Channel" Design Allows Shelf To Be Freely Positioned
- Includes Wall Mounting Brackets For Securing Shelf To Desired Position



Pass-Thru shown with Cantilever Brackets

18" WIDE	Price	24" WIDE	Price	# of Length Brackets
PA-18-24	<b>\$1444</b>	PA-24-24	<b>\$1625</b>	24" 2
PA-18-36	<b>1773</b>	PA-24-36	<b>1784</b>	36" 2
PA-18-48	<b>1929</b>	PA-24-48	<b>2409</b>	48" 2
PA-18-60	<b>2076</b>	PA-24-60	<b>2594</b>	60" 2
PA-18-72	<b>2149</b>	PA-24-72	<b>2779</b>	72" 2
PA-18-84	<b>2224</b>	PA-24-84	<b>3039</b>	84" 3
PA-18-96	<b>2302</b>	PA-24-96	<b>3252</b>	96" 3
PA-18-108	<b>2400</b>	PA-24-108	<b>3268</b>	108" 3
PA-18-120	<b>2444</b>	PA-24-120	<b>3312</b>	120" 3
PA-18-132	<b>2668</b>	PA-24-132	<b>3615</b>	132" 4
PA-18-144	<b>3039</b>	PA-24-144	<b>3879</b>	144" 4

#### Mounting Brackets Included

With Pass-Thru Shelving



**\*2" x 4" - L Bracket**  
For 18" Wide Shelves



**\*\*5" x 5" - Cantilever Bracket**  
For 24" Wide Shelves

### Pass-Thru Shelf with Overshelf

- 1 CU Series Overshelf welded to a PA Series Pass-Thru shelf
- 1-5/8" Stainless Steel Tubing
- Shipped as Welded Set-Up



Pass-Thru with CU Series Shelf & Cantilever Bracket Shown

**Pre-Wiring Available!**  
Contact our **Smart Fab Department** at [smartfab@advancetabco.com](mailto:smartfab@advancetabco.com)

18" WIDE	Price	24" WIDE	Price	# of Length Brackets
PA-18-48-2	<b>\$3966</b>	PA-24-48-2	<b>\$5008</b>	48" 2
PA-18-60-2	<b>4184</b>	PA-24-60-2	<b>5376</b>	60" 2
PA-18-72-2	<b>4332</b>	PA-24-72-2	<b>5680</b>	72" 2
PA-18-84-2	<b>4699</b>	PA-24-84-2	<b>6351</b>	84" 3
PA-18-96-2	<b>4973</b>	PA-24-96-2	<b>6813</b>	96" 3
PA-18-108-2	<b>5279</b>	PA-24-108-2	<b>7207</b>	108" 3
PA-18-120-2	<b>5496</b>	PA-24-120-2	<b>7564</b>	120" 3
PA-18-132-2	<b>5885</b>	PA-24-132-2	<b>7956</b>	132" 4
PA-18-144-2	<b>6354</b>	PA-24-144-2	<b>8710</b>	144" 4

### PASS-THRU MODIFICATION

Includes Side & Top • Minimum Length = 36"

#### Pass-Thru Frame

Length	Model	Price
36"	TA-84F-36	<b>\$1780</b>
48"	TA-84F-48	<b>1975</b>
60"	TA-84F-60	<b>2176</b>
72"	TA-84F-72	<b>2329</b>
84"	TA-84F-84	<b>2450</b>



**Print Required For Proper Location**

## Electrical Utility Chases

**Call For Wiring Installation!**



FLOOR CHASE



CEILING CHASE

- Conceals Wires
- Removable Panel For Wire Access.
- Wiring Available Upon Request.

Available only for CU Series & OTS Series Shelving (Pages 68-69)

MODEL	FEED TYPE	PRICE
UCC-1	Ceiling	<b>\$2353</b>
UCF-1	Floor	<b>2080</b>

**Print required for proper chase location.**  
**Utility Chase is FACTORY INSTALLATION only.**



PIPE CHASE

- Conceals Wires For Heat Lamps.
- Required Installation Of Buyout Equipment

Consult Factory for Wiring

MODEL	PRICE
PC-1	<b>\$924 ea.</b>

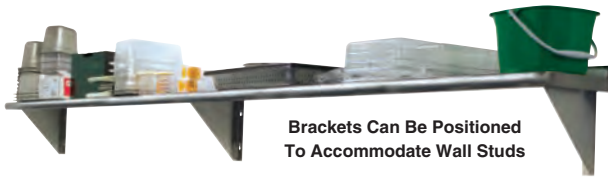

Brackets Can Be Positioned To Accommodate Wall Studs



# SHELVING

## Wall Mounted Shelving

- 1 1/2" Rolled Rim With A 1 1/2" Turn-Up At Rear Ends Are Turned Down Square

### 16 GA. WALL MOUNTED SHELVING

#### 304 Type Stainless Steel

Length	10" WIDE	Price	12" WIDE	Price	15" WIDE	Price	18" WIDE	Price	Approx. Wt.	Approx. Cubes
2'	WS-10-24-16	\$496	WS-12-24-16	\$512	WS-15-24-16	\$840	WS-18-24-16	\$1166	10 lbs.	3
30"	-	-	WS-12-30-16	585	-	-	-	-	11 lbs.	3
3'	WS-10-36-16	534	WS-12-36-16	587	WS-15-36-16	893	WS-18-36-16	1220	12 lbs.	4
42"	-	-	WS-12-42-16	660	-	-	-	-	13 lbs.	5
4'	WS-10-48-16	562	WS-12-48-16	663	WS-15-48-16	948	WS-18-48-16	1272	14 lbs.	5
5'	WS-10-60-16	626	WS-12-60-16	727	WS-15-60-16	1085	WS-18-60-16	1408	17 lbs.	6
6'	WS-10-72-16	673	WS-12-72-16	772	WS-15-72-16	1230	WS-18-72-16	1547	19 lbs.	7
7'	WS-10-84-16	770	WS-12-84-16	854	WS-15-84-16	1322	WS-18-84-16	1623	22 lbs.	8
8'	WS-10-96-16	881	WS-12-96-16	936	WS-15-96-16	1528	WS-18-96-16	1690	26 lbs.	10
9'	WS-10-108-16	967	WS-12-108-16	1016	WS-15-108-16	1642	WS-18-108-16	1826	28 lbs.	11
10'	WS-10-120-16	1090	WS-12-120-16	1159	WS-15-120-16	1690	WS-18-120-16	2031	31 lbs.	12
11'	WS-10-132-16	1077	WS-12-132-16	1219	WS-15-132-16	1937	WS-18-132-16	2109	35 lbs.	13
12'	WS-10-144-16	1162	WS-12-144-16	1251	WS-15-144-16	2060	WS-18-144-16	2187	38 lbs.	14

### 18 GA. WALL MOUNTED SHELVING

#### 430 Type Stainless Steel

Length	10" WIDE	Price	12" WIDE	Price	15" WIDE	Price	18" WIDE	Price	Approx. Wt.	Approx. Cubes
2'	WS-10-24	\$397	WS-12-24	\$409	WS-15-24	\$474	WS-18-24	\$860	10 lbs.	3
30"	-	-	WS-12-30	464	-	-	-	-	12 lbs.	4
3'	WS-10-36	420	WS-12-36	466	WS-15-36	535	WS-18-36	904	12 lbs.	4
42"	-	-	WS-12-42	525	-	-	-	-	14 lbs.	5
4'	WS-10-48	449	WS-12-48	527	WS-15-48	605	WS-18-48	1024	14 lbs.	5
5'	WS-10-60	521	WS-12-60	581	WS-15-60	644	WS-18-60	1062	17 lbs.	6
6'	WS-10-72	564	WS-12-72	620	WS-15-72	697	WS-18-72	1159	19 lbs.	7
7'	WS-10-84	614	WS-12-84	684	WS-15-84	713	WS-18-84	1266	22 lbs.	8
8'	WS-10-96	710	WS-12-96	748	WS-15-96	827	WS-18-96	1341	26 lbs.	10
9'	WS-10-108	736	WS-12-108	814	WS-15-108	1106	WS-18-108	1561	28 lbs.	11
10'	WS-10-120	879	WS-12-120	927	WS-15-120	1136	WS-18-120	1623	31 lbs.	12
11'	WS-10-132	905	WS-12-132	974	WS-15-132	1297	WS-18-132	1705	35 lbs.	13
12'	WS-10-144	943	WS-12-144	999	WS-15-144	1373	WS-18-144	1785	38 lbs.	14

TA-22A	Square Edge Shelf	\$144 ea.	TA-60	Special Sizing Charge For Shelves (Must Order Larger Unit To Be Cut Down To Smaller Size)	N/C
TA-26-10	Weld Support Brackets To Wall Shelf For 10" Deep Wall Shelves	358 ea.	TA-71	Heat Lamp Mounting Provision	228 ea.
TA-26-12	Weld Support Brackets To Wall Shelf For 12" Deep Wall Shelves	358 ea.	TA-77	Check Minder Provision On Any Shelf	81 /lin. ft.
TA-26-15	Weld Support Brackets To Wall Shelf For 15" Deep Wall Shelves	358 ea.	TA-99A	14 Ga. S/S 304 Upgrade For Wall & Over Shelves	65 /lin. ft.
TA-26-18	Weld Support Brackets To Wall Shelf For 18" Deep Wall Shelves	358 ea.	TA-100A	Bullnose Edge On All 4 Sides Of Shelf	144 ea.
TA-49	2" Wall Shelf Offset	253 /shelf			

### K.D. WALL SHELVES

Length	STAINLESS STEEL w/ Stainless Steel Brackets		ALUMINUM w/ Aluminum Brackets		Approx. Wt.	Approx. Cubes
	Model #	Price	Model #	Price		
2'	WS-KD-24	\$349	AWS-KD-24	\$286	10 lbs.	2
3'	WS-KD-36	362	AWS-KD-36	309	12 lbs.	3
4'	WS-KD-48	403	AWS-KD-48	343	14 lbs.	4
5'	WS-KD-60	452	AWS-KD-60	370	17 lbs.	5



Width Of Shelf Is 11-1/8"

Single Shipping Container Can Be Shipped U.P.S.



Custom Sizes are Available. Contact Our SMART FABRICATION™ Department. 800-645-3166

# SHELVING

## Wall Mounted Shelving



## WALL SHELVES

### Slotted Cook Line Wall Shelf



- Heavy Duty
- 304 Type Stainless Steel
- 21" Wide
- 1 1/2" Square Tubes
- 1 1/4" Spacing
- Tubular Support Brackets (Shipped Loose To Suit Wall Stud Location)

TA-26-21 **\$480 per shelf**  
Optional Factory Welded Shelf Brackets (Print Required)

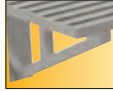

L	Model #	Price	# of Brackets	Approx. Wt.	Approx. Cubes
48"	DT21-4	<b>\$5134</b>	2	90 lbs.	6
72"	DT21-6	<b>7701</b>	3	105 lbs.	8
96"	DT21-8	<b>10266</b>	3	145 lbs.	10
120"	DT21-10	<b>12835</b>	4	190 lbs.	13
144"	DT21-12	<b>15399</b>	4	210 lbs.	15

**NOTE: Recommend Field Welding Brackets To Underside Of Cook Line Shelf**

### Built-In Check Minder



Floating Ball Mechanism Quickly Grabs Checks And Holds Them In Place

L	12" WIDE	Price	Approx. Wt.	Approx. Cubes
3'	WS-12-36CM	<b>\$551</b>	15 lbs.	4
4'	WS-12-48CM	<b>609</b>	19 lbs.	5
5'	WS-12-60CM	<b>658</b>	21 lbs.	6
6'	WS-12-72CM	<b>702</b>	25 lbs.	7
8'	WS-12-96CM	<b>831</b>	32 lbs.	10

### Under Mounted Multi-Purpose Shelf

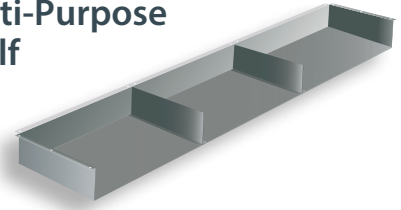

- Heavy Duty
- Mounts below shelving or table top
- Supplied with mounting holes.
- 1 stationary divider included 36" lengths & under 2 stationary dividers included over 36" lengths

Model #	Price	Approx. Wt.
TA-117	<b>\$386 lin. ft.</b>	22 lbs. per sq. ft.

TA-117A **\$151 ea.**  
Additional Dividers

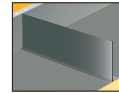

**FACTORY INSTALLED ONLY**

### with Built-In Pot Rack



Length	12" WIDE	Price	15" WIDE	Price	18" WIDE	Price	# of Hooks	Approx. Wt.	Approx. Cubes
3'	PS-12-36	<b>\$1118</b>	PS-15-36	<b>\$1349</b>	PS-18-36	<b>\$1716</b>	6	30 lbs.	5
4'	PS-12-48	<b>1178</b>	PS-15-48	<b>1417</b>	PS-18-48	<b>1837</b>	6	40 lbs.	6
5'	PS-12-60	<b>1229</b>	PS-15-60	<b>1456</b>	PS-18-60	<b>1876</b>	9	50 lbs.	7
6'	PS-12-72	<b>1269</b>	PS-15-72	<b>1507</b>	PS-18-72	<b>1970</b>	9	60 lbs.	8
7'	PS-12-84	<b>1332</b>	PS-15-84	<b>1528</b>	PS-18-84	<b>2080</b>	9	70 lbs.	10
8'	PS-12-96	<b>1398</b>	PS-15-96	<b>1639</b>	PS-18-96	<b>2153</b>	9	80 lbs.	11
9'	PS-12-108	<b>1465</b>	PS-15-108	<b>1916</b>	PS-18-108	<b>2372</b>	9	90 lbs.	12
10'	PS-12-120	<b>1577</b>	PS-15-120	<b>1948</b>	PS-18-120	<b>2434</b>	9	100 lbs.	13
11'	PS-12-132	<b>1623</b>	PS-15-132	<b>2109</b>	PS-18-132	<b>2518</b>	9	110 lbs.	14
12'	PS-12-144	<b>1650</b>	PS-15-144	<b>2187</b>	PS-18-144	<b>2597</b>	9	120 lbs.	26

- TA-60 Special Sizing Charge for Wall Shelves
- TA-99 16 ga. 304 Upgrade for Wall and Over Shelves
- TA-99A 14 Ga. S/S 304 Upgrade for Wall & Over Shelves

**N/C - Add to next longer shelf \$35 / lin. ft. 65 / lin. ft.**



**FOR CHECK MINDER PROVISION**  
On Any Shelf Use

TA-77  
**\$81/lin. ft.**



### Wall Shelf w/Multipurpose Undershef



Shown with Microwave Units (Not Included)

- 5 1/2" Undershef
- Upper & Lower Grommet Holes



Size W x L	Model #	Price	Approx. Wt.	Approx. Cubes
24" x 24"	MS-24-24-PS	<b>\$2039</b>	58 lbs.	11
24" x 36"	MS-24-36-PS	<b>2384</b>	85 lbs.	16
24" x 48"	MS-24-48-PS	<b>2731</b>	110 lbs.	21

### Microwave Shelf

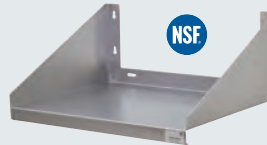

Size W x L	Model #	Price	Approx. Wt.	Approx. Cubes
18" x 24"	MS-18-24	<b>\$779</b>	27 lbs.	5
24" x 24"	MS-24-24	<b>883</b>	32 lbs.	5
24" x 36"	MS-24-36	<b>1230</b>	38 lbs.	7
20" x 30"	MS-20-30	<b>1139</b>	36 lbs.	5

TA-108 **\$191**  
2" Hole with Grommet For Appliance Cord. (Please Specify Hole Size And Location)



### 8" Wide Utility Shelf

Length	Model #	Price	Approx. Wt.	Approx. Cubes
24"	K-245	<b>\$1104</b>	50 lbs.	1
36"	K-246	<b>1253</b>	55 lbs.	2



## Single Shelf

 = Ship Via UPS

Length	Model #	Price	Approx. Wt.	Approx. Cubes
3'	CM-18-36	\$3770	24 lbs.	4
4'	CM-18-48	4043	29 lbs.	5
5'	CM-18-60	4309	35 lbs.	6
6'	CM-18-72	4578	40 lbs.	7
7'	CM-18-84	4585	46 lbs.	8
8'	CM-18-96	4703	51 lbs.	9

## Double Shelves

Length	Model #	Price	Approx. Wt.	Approx. Cubes
3'	DCM-18-36	\$4846	55 lbs.	5
4'	DCM-18-48	5655	60 lbs.	6
5'	DCM-18-60	5924	66 lbs.	7
6'	DCM-18-72	6734	72 lbs.	8
7'	DCM-18-84	6829	78 lbs.	9
8'	DCM-18-96	7052	84 lbs.	10

- Stainless Steel
- 1 5/8" Stainless Steel Posts
- Shipped KD
- Load Capacity is 5 lbs. per sq. ft. (Evenly Distributed)

**CUSTOMER MUST SPECIFY CEILING HEIGHT**

# SHELVING

## Shelving & Modifications

### 18" WIDE CEILING MOUNTED SHELVING

SINGLE

DOUBLE



## SHELVING MODIFICATIONS

FACTORY INSTALLED ONLY

### Printer Shelf

- Heavy gauge stainless steel
- 8"x16" Printer Deck
- 10" height
- 1 Data Port Receptacle
- 1 Electrical Receptacle
- Rear Gem Box with Removable Enclosure
- Turned up front edge to hold Printer in place



**PRT-1 \$1223 /shelf** Back of Shelf Shown

### Check Minder



- Extruded Anodized Aluminum
- Holds checks with ease
- Floating ball mechanism quickly grabs checks & holds them in place
- Mounts to any shelf

**TA-77 \$81 /lin. ft.**

**TA-77A \$58 /lin. ft.**

Concealer for Heat Lamp. (Requires a TA-77)

### Microwave Shelf Extension



24" Front to Back  
1-5/8" Posts

Use the full length of OTS Shelves found on page 74 and then add **TA-102 \$595** extension. Specify Right or Left.

### Table Mounted Equipment Shelf



1-5/8" Posts

L	Model #	Price	Approx. Wt.	Approx. Cubes
2'	MST-24-24	\$1613	32 lbs.	1
3'	MST-24-36	1885	38 lbs.	2

### 6" Shelf Offset



- Posts located towards rear shelf
- Provides shelf reach
- Available for 18" or Wider shelving Only (CU Series Shelving)

**TA-120 \$178 /Per level**

## Accessories

### Check Minder Accessory



- Holds Checks With Ease
- Floating Ball Mechanism Quickly Grabs Checks & Holds Them In Place
- Mounts To Existing Wall Or Shelf

Length	Model #	Price	Approx. Wt.
2'	CM-24	\$77	1.5 lbs.
3'	CM-36	97	2.25 lbs.
4'	CM-48	111	3 lbs.
5'	CM-60	125	4.25 lbs.

### Wall Cap



- 16 ga., 304 Stainless Steel
- 2" x Wall Thickness x 2" x Height

Model #	Price
<b>WALLCAP</b>	<b>\$79 Lin. ft.</b>

**MUST SPECIFY:**

**Wall thickness** (maximum 6")

**Height** (Maximum of 10 feet)

Minimum charge 4 linear feet

### Bumper Guards



- 16 ga., 304 Stainless Steel
- Bracket Included

Model #	Size	Price
<b>BG-48</b>	2" x 4" x 48"	<b>\$298</b>
<b>BG-60</b>	2" x 4" x 60"	<b>403</b>

### Corner Guards



- 16 ga., 304 Stainless Steel
- Adhesive Tape Backing

Model #	Size	Price
<b>CG-48</b>	2" x 2" x 48"	<b>\$202</b>
<b>CG-60</b>	2" x 2" x 60"	<b>266</b>
<b>CG-72</b>	2" x 2" x 72"	<b>296</b>
<b>CG-84</b>	2" x 2" x 84"	<b>349</b>
<b>CG-96</b>	2" x 2" x 96"	<b>382</b>
<b>CG-120</b>	2" x 2" x 120"	<b>414</b>
	<b>4" x 4"</b>	
<b>OCG-48-SS</b>	4" x 4" x 48"	<b>382</b>

# POT RACKS

## Adjustable Pot Rack Components



**#1** HOW TO ORDER  
Select from  
3 Mounting  
Provisions

*Mid, Rear or Splash*

**#2** Choose  
Desired  
Components



### TABLE with POT RACK, SHELVING & UTENSIL RACK MID MOUNT DESIGN



MIX & MATCH to Maximize Your Work Area. Components are Adjustable. You set the Height to Meet Your Demanding Requirement.

#### SPECIFY MOUNTING PROVISION

FOR MID MOUNT  
Add TA-228 N/C



FOR REAR MOUNT  
ADD TA-229 N/C



FOR SPLASH MOUNT  
ADD TA-227 N/C



#### Pot Racks (Includes Utensil Rack)

#### Utensil Racks

Length	Model #	# of Pot Hooks	Price	Approx. Wt.	Approx. Cubes	Utensil Racks				
						Model #	# of Pot Hooks	Price	Approx. Wt.	Approx. Cubes
36"	SCT-36	12	\$2033	30	5	AUR-36	6	\$768	30	2
48"	SCT-48	12	2109	34	6	AUR-48	6	780	34	3
60"	SCT-60	18	2167	37	7	AUR-60	9	836	37	3
72"	SCT-72	18	2987	46	9	AUR-72	9	876	46	4
84"	SCT-84	18	3059	50	10	AUR-84	9	1026	50	5
96"	SCT-96	18	3267	55	12	AUR-96	9	1123	55	5
108"	SCT-108	18	3978	60	13	AUR-108	9	1412	60	6
120"	SCT-120	18	4310	65	15	AUR-120	9	1498	65	7
132"	SCT-132	18	4429	68	16	AUR-132	9	1696	68	7
144"	SCT-144	18	4516	72	18	AUR-144	9	1883	72	8
36"	SWT-36	12	\$1616	30	5	AUR-36	6	\$768	30	2
48"	SWT-48	12	1657	34	6	AUR-48	6	780	34	3
60"	SWT-60	18	1675	37	7	AUR-60	9	836	37	3
72"	SWT-72	18	1696	46	9	AUR-72	9	876	46	4
84"	SWT-84	18	2033	50	10	AUR-84	9	1026	50	5
96"	SWT-96	18	2070	55	12	AUR-96	9	1123	55	5
108"	SWT-108	18	2460	60	13	AUR-108	9	1412	60	6
120"	SWT-120	18	2487	65	15	AUR-120	9	1498	65	7
132"	SWT-132	18	2547	68	16	AUR-132	9	1696	68	7
144"	SWT-144	18	2606	72	18	AUR-144	9	1883	72	8
36"	SWT-36	12	\$1616	30	5	AUR-36	6	\$768	30	2
48"	SWT-48	12	1657	34	6	AUR-48	6	780	34	3
60"	SWT-60	18	1675	37	7	AUR-60	9	836	37	3
72"	SWT-72	18	1696	46	9	AUR-72	9	876	46	4
84"	SWT-84	18	2033	50	10	AUR-84	9	1026	50	5
96"	SWT-96	18	2070	55	12	AUR-96	9	1123	55	5
108"	SWT-108	18	2460	60	13	AUR-108	9	1412	60	6
120"	SWT-120	18	2487	65	15	AUR-120	9	1498	65	7
132"	SWT-132	18	2547	68	16	AUR-132	9	1696	68	7
144"	SWT-144	18	2606	72	18	AUR-144	9	1883	72	8

Pot Racks 8' Or Longer, Include Center Leg Support

# SHELVING

## Adjustable Shelving Components Convert Your Table into an Effective Work Station

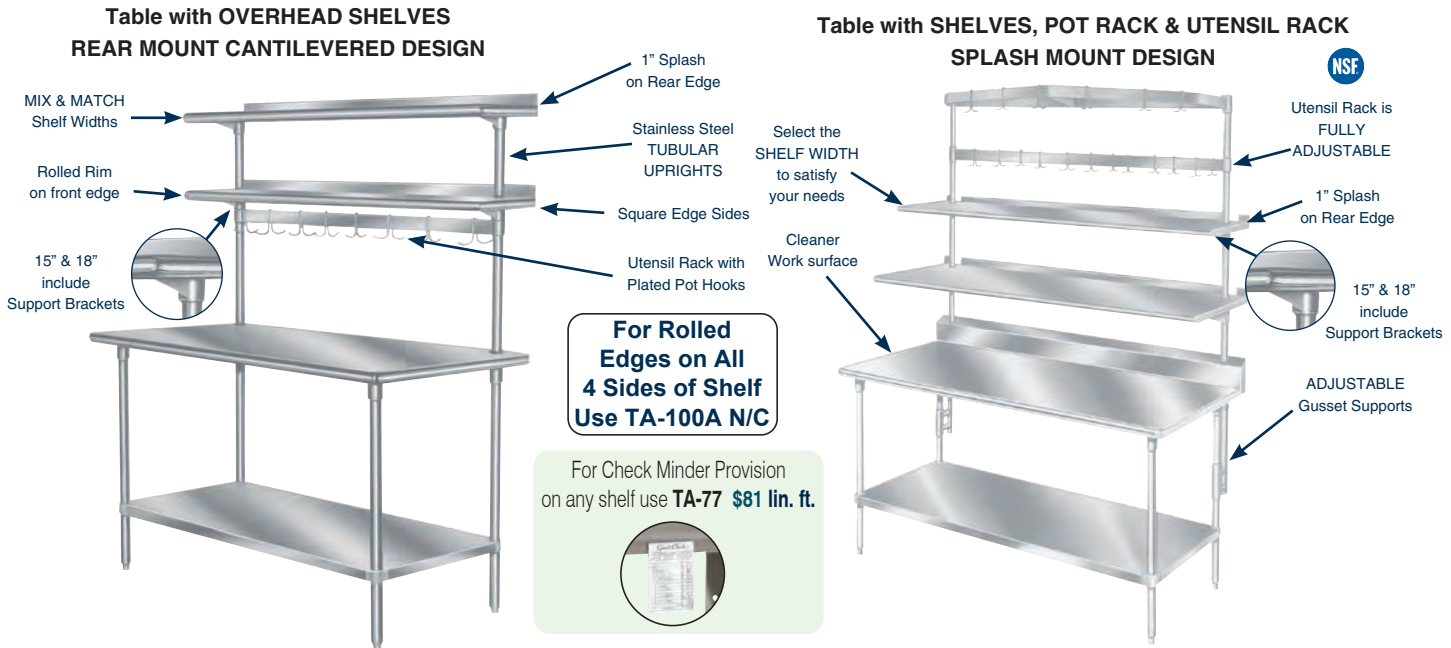

ADD - CHANGE - MODIFY with Components to Meet the Demanding Prep-Requirements of an Upgrading or Changing Food Service Environment

### Adjustable Shelves

Length	10" WIDE	Price	12" WIDE	Price	15" WIDE	Price	18" WIDE	Price	Approx. Wt.	Approx. Cubes
36"	PT-10-36	\$678	PT-12-36	\$711	PT-15-36	\$796	PT-18-36	\$887	30	2
48"	PT-10-48	728	PT-12-48	760	PT-15-48	850	PT-18-48	950	34	3
60"	PT-10-60	763	PT-12-60	814	PT-15-60	912	PT-18-60	1018	37	3
72"	PT-10-72	800	PT-12-72	860	PT-15-72	964	PT-18-72	1076	46	4
84"	PT-10-84	836	PT-12-84	904	PT-15-84	1013	PT-18-84	1130	50	5
96"	PT-10-96	1170	PT-12-96	1264	PT-15-96	1417	PT-18-96	1581	55	5
108"	PT-10-108	1312	PT-12-108	1417	PT-15-108	1585	PT-18-108	1770	60	6
120"	PT-10-120	1467	PT-12-120	1585	PT-15-120	1778	PT-18-120	1983	65	7
132"	PT-10-132	1643	PT-12-132	1778	PT-15-132	1990	PT-18-132	2222	68	7
144"	PT-10-144	1841	PT-12-144	1990	PT-15-144	2229	PT-18-144	2487	72	8
36"	PT-10R-36	\$800	PT-12R-36	\$832	PT-15R-36	\$932	PT-18R-36	\$1040	30	2
48"	PT-10R-48	838	PT-12R-48	886	PT-15R-48	994	PT-18R-48	1109	34	3
60"	PT-10R-60	886	PT-12R-60	943	PT-15R-60	1056	PT-18R-60	1179	37	3
72"	PT-10R-72	936	PT-12R-72	999	PT-15R-72	1119	PT-18R-72	1250	46	4
84"	PT-10R-84	985	PT-12R-84	1058	PT-15R-84	1185	PT-18R-84	1324	50	5
96"	PT-10R-96	1376	PT-12R-96	1482	PT-15R-96	1661	PT-18R-96	1852	55	5
108"	PT-10R-108	1542	PT-12R-108	1661	PT-15R-108	1859	PT-18R-108	2075	60	6
120"	PT-10R-120	1727	PT-12R-120	1859	PT-15R-120	2083	PT-18R-120	2324	65	7
132"	PT-10R-132	1936	PT-12R-132	2083	PT-15R-132	2333	PT-18R-132	2605	68	7
144"	PT-10R-144	2167	PT-12R-144	2333	PT-15R-144	2611	PT-18R-144	2914	72	8
36"	PT-10S-36	\$1020	PT-12S-36	\$1058	PT-15S-36	\$1185	PT-18S-36	\$1324	30	2
48"	PT-10S-48	1075	PT-12S-48	1117	PT-15S-48	1251	PT-18S-48	1396	34	3
60"	PT-10S-60	1117	PT-12S-60	1166	PT-15S-60	1305	PT-18S-60	1459	37	3
72"	PT-10S-72	1162	PT-12S-72	1230	PT-15S-72	1377	PT-18S-72	1538	46	4
84"	PT-10S-84	1213	PT-12S-84	1286	PT-15S-84	1439	PT-18S-84	1608	50	5
96"	PT-10S-96	1701	PT-12S-96	1801	PT-15S-96	2016	PT-18S-96	2251	55	5
108"	PT-10S-108	1870	PT-12S-108	1982	PT-15S-108	2220	PT-18S-108	2475	60	6
120"	PT-10S-120	2057	PT-12S-120	2178	PT-15S-120	2441	PT-18S-120	2724	65	7
132"	PT-10S-132	2263	PT-12S-132	2398	PT-15S-132	2684	PT-18S-132	2996	68	7
144"	PT-10S-144	2488	PT-12S-144	2638	PT-15S-144	2954	PT-18S-144	3295	72	8

Shelves 8' Or Longer, Include Center Leg Support

# POT RACKS

## Additional Pot Racks

### STAINLESS STEEL WALL MOUNTED POT RACKS

Includes Pot Hooks

#### Single Bar

Length	Stainless Steel		Aluminum				
	Model #	Price	Model #	Price	# Of Hooks	Wt.	Cu.
2'	NOT AVAILABLE		ALW-24	\$469	6	5 lbs.	1.0
3'	SW1-36	\$880	ALW-36	581	6	6 lbs.	1.5
4'	SW1-48	905	ALW-48	633	6	7 lbs.	2.0
5'	SW1-60	969	NOT AVAILABLE				2.5
6'	SW1-72	961					3.0
7'	SW1-84	985					3.5
8'	SW1-96	1082					4.0
9'	SW1-108	1191					4.5
10'	SW1-120	1295	5.0				

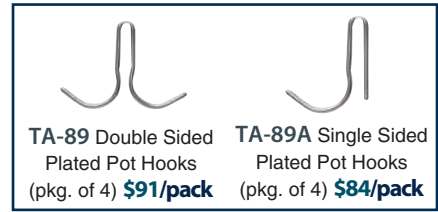

SW1-36 Shown

#### Double Bar

Length	Model #	Price	# Of Hooks	Wt.	Cu.
2'	SW-24	\$1219	12	18 lbs.	4
3'	SW-36	1320	12	22 lbs.	5
4'	SW-48	1364	12	26 lbs.	6
5'	SW-60	1466	18	30 lbs.	7
6'	SW-72	1540	18	34 lbs.	9
7'	SW-84	1701	18	44 lbs.	10
8'	SW-96	1764	18	48 lbs.	12
9'	SW-108	2086	18	52 lbs.	13
10'	SW-120	2281	18	56 lbs.	15
11'	SW-132	2475	18	60 lbs.	16
12'	SW-144	2617	18	64 lbs.	18



SW-36 Shown

## CEILING MOUNTED STAINLESS STEEL POT RACKS

Hangs 36" From Ceiling • Includes Pot Hooks



Length	Model #	Price	# Of Hooks	Wt.	Cu.
3'	SC-36	\$2265	12	42 lbs.	5
4'	SC-48	2308	12	48 lbs.	6
5'	SC-60	2404	18	54 lbs.	7
6'	SC-72	2508	18	60 lbs.	9
7'	SC-84	2796	18	66 lbs.	10
8'	SC-96	3165	18	80 lbs.	12
9'	SC-108	3528	18	86 lbs.	13
10'	SC-120	3950	18	92 lbs.	15
11'	SC-132	4162	18	98 lbs.	16
12'	SC-144	4621	18	104 lbs.	18

TA-98 Stainless Steel Flat Bar in lieu of Chain **\$414/pot rack**

## LEG MOUNTED POT RACK

For 30" Wide Tables

Includes 6 Pot Hooks Per Unit



**Stainless Steel**

**UB-30**  
**\$579**  
Wt. 10 lbs.

For Adjustable Pot Rack Components  
See Page 80

# DISHTABLE STANDARDS



Shown with 8" Deep Sink Bowl, Pre-rinse Basket & Slide Bar

## Features and Benefits

- 3/4" Radius Corner Sink Bowls
- 10 1/2" Tile Edge Backsplash
- 1 5/8" Tubular Legs
- Economical Savings
- Satin Finish

## SPEC-LINE "30" Series

- 14 ga. 304 Stainless Steel Top
- Stainless Steel Cross Bracing on Sides
- 16 ga. 304 Stainless Steel Legs & Adjust. Bullet Feet
- 10 1/2" Backsplash
- 8" Deep Sink Bowls (Soil Units)



## STANDARD "70" Series

- 16 ga. 304 Stainless Steel Top
- Stainless Steel Cross Bracing on Sides
- Stainless Steel Legs and Adjust. Bullet Feet
- 10 1/2" Backsplash
- 5" Deep Sink Bowls (Soil Units)



## SUPERSAVER "60" Series

- 16 ga. 304 Stainless Steel Top
- Galvanized Legs & Adjust. Plastic Bullet Feet
- 10 1/2" Backsplash
- 5" Deep Sink Bowls (Soil Units)



**WHEN PLACING AN ORDER, PLEASE PROVIDE THE DISH MACHINE MODEL NUMBER TO ENSURE PROPER DISHTABLE COMPATIBILITY.**

**Due to some machine manufacturer's recommendations for specific service access, the following modifications will apply...**

### **DTA-76 (Relocate sink location)**

*Dish Machines that require a **DTA-76**:*

ES-4400, ES-6600, WH-series, APEX TSC-V  
CMA 180 (Right-side), 44, 66  
Hobart AM-15 (corner configuration) C-series, CL-series,  
CCS-66/77/86/110, CRS-series  
Jackson AJ-series, TS-series, TSC-series  
Meiko K-series  
Stero SCT-series

**DTA-76: No Charge**

### **DTA-78 (Notch in backsplash to clear handle)**

*Dish Machines that require a **DTA-78**:*

ADS HT-25, SS-25  
Blakeslee D-8, D-9  
Ecolab ES-4000  
Electrolux WT65  
Hobart AM-15 (Corner Configuration)

**DTA-78: \$204**

# DISHTABLES

## Soil Dishtables



**! ATTENTION:**  
See Dish Machine Information on Pg. 83 to ensure proper compatibility

### STRAIGHT SOIL DISHTABLES

Spec-Line S30 Series

Standard S70 Series

Super Saver S60 Series

14 Ga.

16 Ga.

16 Ga. w/ Galvanized Legs

Nominal Size	Length	Model #	Price	Model #	Price	Model #	Price	Approx. Weight	Approx. Cu. Ft.
3 Ft.	35"	DTS-S30-36LorR	\$4963	DTS-S70-36LorR	\$4187	DTS-S60-36LorR	\$3984	70 lbs.	12
4 Ft.	47"	DTS-S30-48LorR	5203	DTS-S70-48LorR	4324	DTS-S60-48LorR	4128	85 lbs.	17
5 Ft.	59"	DTS-S30-60LorR	5321	DTS-S70-60LorR	4469	DTS-S60-60LorR	4271	100 lbs.	19
6 Ft.	71"	DTS-S30-72LorR	5530	DTS-S70-72LorR	4699	DTS-S60-72LorR	4500	115 lbs.	23
7 Ft.	83"	DTS-S30-84LorR	5689	DTS-S70-84LorR	5041	DTS-S60-84LorR	4754	125 lbs.	27
8 Ft.	95"	DTS-S30-96LorR	5770	DTS-S70-96LorR	5350	DTS-S60-96LorR	4835	135 lbs.	31
9 Ft.	107"	DTS-S30-108LorR	6852	DTS-S70-108LorR	5755	DTS-S60-108LorR	5517	235 lbs.	45
10 Ft.	119"	DTS-S30-120LorR	7332	DTS-S70-120LorR	6326	DTS-S60-120LorR	6043	290 lbs.	50
12 Ft.	143"	DTS-S30-144LorR	8487	DTS-S70-144LorR	6933	DTS-S60-144LorR	6651	320 lbs.	60

Faucet Holes are Splash Mounted 8" O.C.

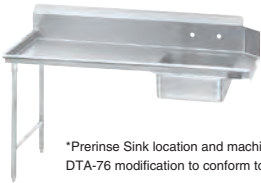

\*Pre-rinse Sink location and machine opening may require DTA-76 modification to conform to Dishmachine requirements.

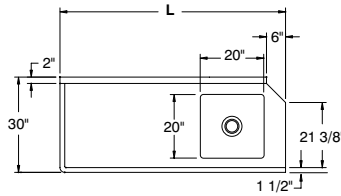

LEFT SOIL TABLE

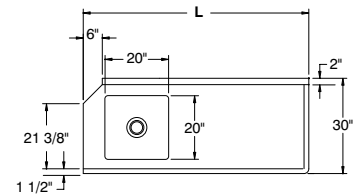

RIGHT SOIL TABLE



### CORNER SOIL DISHTABLES

Spec-Line K30 Series

Standard K70 Series

Super Saver K60 Series

14 Ga.

16 Ga.

16 Ga. w/ Galvanized Legs

Nominal Size	Length	Model #	Price	Model #	Price	Model #	Price	Approx. Weight	Approx. Cu. Ft.
4 Ft.	47"	DTS-K30-48LorR	\$9119	DTS-K70-48LorR	\$8337	DTS-K60-48LorR	\$7968	128 lbs.	29
5 Ft.	59"	DTS-K30-60LorR	9336	DTS-K70-60LorR	8472	DTS-K60-60LorR	8151	138 lbs.	37
6 Ft.	71"	DTS-K30-72LorR	9501	DTS-K70-72LorR	8683	DTS-K60-72LorR	8380	149 lbs.	44
7 Ft.	83"	DTS-K30-84LorR	9765	DTS-K70-84LorR	8877	DTS-K60-84LorR	8643	163 lbs.	51
8 Ft.	95"	DTS-K30-96LorR	9928	DTS-K70-96LorR	9097	DTS-K60-96LorR	8731	182 lbs.	58
9 Ft.	107"	DTS-K30-108LorR	10291	DTS-K70-108LorR	9562	DTS-K60-108LorR	9115	355 lbs.	83
10 Ft.	119"	DTS-K30-120LorR	10789	DTS-K70-120LorR	10388	DTS-K60-120LorR	9321	380 lbs.	92
12 Ft.	143"	DTS-K30-144LorR	11919	DTS-K70-144LorR	10075	DTS-K60-144LorR	10720	390 lbs.	110

Faucet Holes are Splash Mounted 8" O.C.



\*Pre-rinse Sink location and machine opening may require DTA-76 modification to conform to Dishmachine requirements.

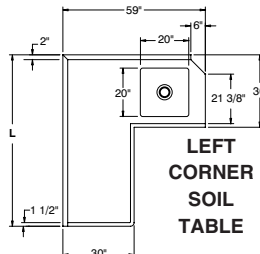

LEFT CORNER SOIL TABLE

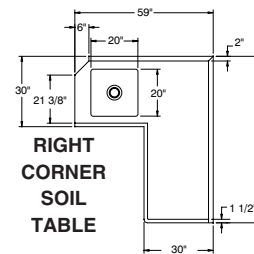

RIGHT CORNER SOIL TABLE

**! ATTENTION:**

See Dish Machine Information on Pg. 83 to ensure proper compatibility



# DISHTABLES

## Soil Dishtables

### ISLAND SOIL DISHTABLES

Spec-Line G30 Series

Standard G70 Series

Super Saver G60 Series

14 Ga.

16 Ga.

16 Ga. w/ Galvanized Legs

Nominal Size	Length	Model #	Price	Model #	Price	Model #	Price	Approx. Weight	Approx. Cu. Ft.
4 Ft.	47"	DTS-G30-48LorR	\$8539	DTS-G70-48LorR	\$7821	DTS-G60-48LorR	\$7478	129 lbs.	29
5 Ft.	59"	DTS-G30-60LorR	8733	DTS-G70-60LorR	7964	DTS-G60-60LorR	7651	138 lbs.	37
6 Ft.	71"	DTS-G30-72LorR	8958	DTS-G70-72LorR	8151	DTS-G60-72LorR	7878	150 lbs.	44
7 Ft.	83"	DTS-G30-84LorR	9150	DTS-G70-84LorR	8391	DTS-G60-84LorR	8131	162 lbs.	51
8 Ft.	95"	DTS-G30-96LorR	9309	DTS-G70-96LorR	8565	DTS-G60-96LorR	8212	178 lbs.	58
9 Ft.	107"	DTS-G30-108LorR	9551	DTS-G70-108LorR	8979	DTS-G60-108LorR	8815	335 lbs.	83
10 Ft.	119"	DTS-G30-120LorR	9951	DTS-G70-120LorR	9744	DTS-G60-120LorR	9562	365 lbs.	92
12 Ft.	143"	DTS-G30-144LorR	10493	DTS-G70-144LorR	10285	DTS-G60-144LorR	10119	380 lbs.	110



\*Prerinse Sink location and machine opening may require DTA-76 modification to conform to Dishmachine requirements.

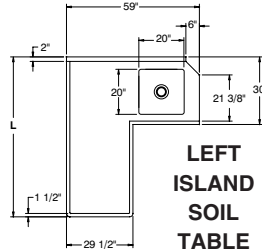

LEFT ISLAND SOIL TABLE

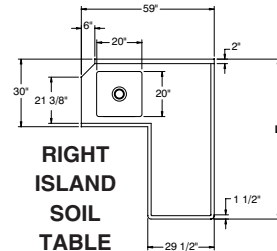

RIGHT ISLAND SOIL TABLE

Faucet Holes are Splash Mounted 8" O.C.

### DISHLANDING SOIL DISHTABLES

Spec-Line D30 Series

Standard D70 Series

Super Saver D60 Series

14 Ga.

16 Ga.

16 Ga. w/ Galvanized Legs

Nominal Size	Length	Model #	Price	Model #	Price	Model #	Price	Approx. Weight	Approx. Cu. Ft.
4 Ft.	47"	DTS-D30-48LorR	\$10225	DTS-D70-48LorR	\$9314	DTS-D60-48LorR	\$9117	139 lbs.	33
5 Ft.	59"	DTS-D30-60LorR	10439	DTS-D70-60LorR	9504	DTS-D60-60LorR	9357	147 lbs.	41
6 Ft.	71"	DTS-D30-72LorR	10712	DTS-D70-72LorR	9716	DTS-D60-72LorR	9539	160 lbs.	50
7 Ft.	83"	DTS-D30-84LorR	11040	DTS-D70-84LorR	9932	DTS-D60-84LorR	9757	175 lbs.	58
8 Ft.	95"	DTS-D30-96LorR	11117	DTS-D70-96LorR	10156	DTS-D60-96LorR	9935	205 lbs.	66
9 Ft.	107"	DTS-D30-108LorR	11642	DTS-D70-108LorR	10382	DTS-D60-108LorR	10167	320 lbs.	93
10 Ft.	119"	DTS-D30-120LorR	12112	DTS-D70-120LorR	10986	DTS-D60-120LorR	10720	365 lbs.	103
12 Ft.	143"	DTS-D30-144LorR	12641	DTS-D70-144LorR	11458	DTS-D60-144LorR	11250	390 lbs.	123



\*Prerinse Sink location and machine opening may require DTA-76 modification to conform to Dishmachine requirements.

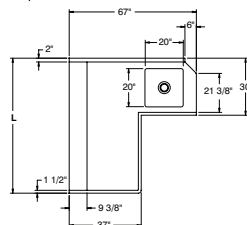

LEFT DISHLANDING SOIL TABLE

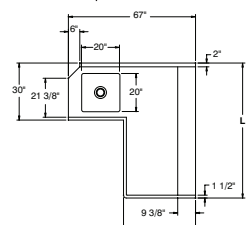

RIGHT DISHLANDING SOIL TABLE

# DISHTABLES

## Clean Dishtables

**! ATTENTION:**  
See Dish Machine Information on Pg. 83 to ensure proper compatibility

### STRAIGHT CLEAN DISHTABLES

Spec-Line S30 Series

Standard S70 Series

Super Saver S60 Series

14 Ga.

16 Ga.

16 Ga. w/ Galvanized Legs

Nominal Size	Length	Model #	Price	Model #	Price	Model #	Price	Approx. Weight	Approx. Cu. Ft.
2 Ft.	23"	DTC-S30-24LorR	\$2450	DTC-S70-24LorR	\$2314	DTC-S60-24LorR	\$2107	35 lbs.	12
3 Ft.	35"	DTC-S30-36LorR	2969	DTC-S70-36LorR	2658	DTC-S60-36LorR	2451	45 lbs.	12
4 Ft.	47"	DTC-S30-48LorR	3109	DTC-S70-48LorR	2894	DTC-S60-48LorR	2687	60 lbs.	17
5 Ft.	59"	DTC-S30-60LorR	3313	DTC-S70-60LorR	3066	DTC-S60-60LorR	2856	70 lbs.	19
6 Ft.	71"	DTC-S30-72LorR	3495	DTC-S70-72LorR	3213	DTC-S60-72LorR	3007	85 lbs.	23
7 Ft.	83"	DTC-S30-84LorR	4243	DTC-S70-84LorR	3570	DTC-S60-84LorR	3278	100 lbs.	27
8 Ft.	95"	DTC-S30-96LorR	4440	DTC-S70-96LorR	3871	DTC-S60-96LorR	3358	110 lbs.	31
9 Ft.	107"	DTC-S30-108LorR	4937	DTC-S70-108LorR	4366	DTC-S60-108LorR	4117	225 lbs.	45
10 Ft.	119"	DTC-S30-120LorR	5133	DTC-S70-120LorR	4704	DTC-S60-120LorR	4418	250 lbs.	50
12 Ft.	143"	DTC-S30-144LorR	5643	DTC-S70-144LorR	5151	DTC-S60-144LorR	4852	270 lbs.	60



**NSF**  
Optional Undershelf

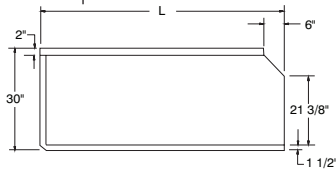

LEFT CLEAN TABLE

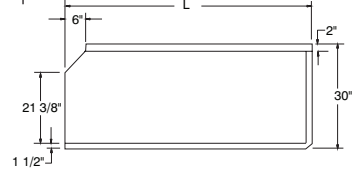

RIGHT CLEAN TABLE

### CORNER CLEAN DISHTABLES

Spec-Line K30 Series

Standard K70 Series

Super Saver K60 Series

14 Ga.

16 Ga.

16 Ga. w/ Galvanized Legs

Nominal Size	Length	Model #	Price	Model #	Price	Model #	Price	Approx. Weight	Approx. Cu. Ft.
4 Ft.	47"	DTC-K30-48LorR	\$6559	DTC-K70-48LorR	\$6097	DTC-K60-48LorR	\$5721	105 lbs.	29
5 Ft.	59"	DTC-K30-60LorR	6744	DTC-K70-60LorR	6265	DTC-K60-60LorR	5871	115 lbs.	37
6 Ft.	71"	DTC-K30-72LorR	7033	DTC-K70-72LorR	6723	DTC-K60-72LorR	6133	125 lbs.	44
7 Ft.	83"	DTC-K30-84LorR	7366	DTC-K70-84LorR	6982	DTC-K60-84LorR	6397	138 lbs.	51
8 Ft.	95"	DTC-K30-96LorR	7444	DTC-K70-96LorR	7068	DTC-K60-96LorR	6476	157 lbs.	58
9 Ft.	107"	DTC-K30-108LorR	9228	DTC-K70-108LorR	8731	DTC-K60-108LorR	8231	330 lbs.	83
10 Ft.	119"	DTC-K30-120LorR	9669	DTC-K70-120LorR	9133	DTC-K60-120LorR	8544	360 lbs.	92
12 Ft.	143"	DTC-K30-144LorR	10635	DTC-K70-144LorR	9987	DTC-K60-144LorR	9401	380 lbs.	110



**NSF**

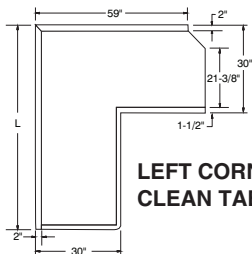

LEFT CORNER CLEAN TABLE

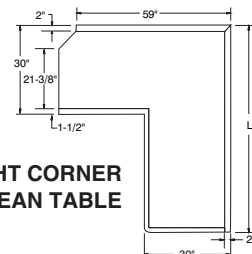

RIGHT CORNER CLEAN TABLE



**! ATTENTION:**

See Dish Machine Information on Pg. 83 to ensure proper compatibility

# DISHTABLES

## Clean Dishtables

### ISLAND CLEAN DISHTABLES

Spec-Line G30 Series

Standard G70 Series

Super Saver G60 Series

14 Ga.

16 Ga.

16 Ga. w/ Galvanized Legs

Nominal Size	Length	Model #	Price	Model #	Price	Model #	Price	Approx. Weight	Approx. Cu. Ft.
4 Ft.	47"	DTC-G30-48LorR	\$6373	DTC-G70-48LorR	\$5750	DTC-G60-48LorR	\$5531	102 lbs.	29
5 Ft.	59"	DTC-G30-60LorR	6562	DTC-G70-60LorR	5993	DTC-G60-60LorR	5688	112 lbs.	37
6 Ft.	71"	DTC-G30-72LorR	6850	DTC-G70-72LorR	6136	DTC-G60-72LorR	5942	125 lbs.	44
7 Ft.	83"	DTC-G30-84LorR	7172	DTC-G70-84LorR	6410	DTC-G60-84LorR	6207	135 lbs.	51
8 Ft.	95"	DTC-G30-96LorR	7255	DTC-G70-96LorR	6500	DTC-G60-96LorR	6285	148 lbs.	58
9 Ft.	107"	DTC-G30-108LorR	8980	DTC-G70-108LorR	8001	DTC-G60-108LorR	7734	310 lbs.	83
10 Ft.	119"	DTC-G30-120LorR	9297	DTC-G70-120LorR	8560	DTC-G60-120LorR	8171	340 lbs.	92
12 Ft.	143"	DTC-G30-144LorR	10227	DTC-G70-144LorR	9588	DTC-G60-144LorR	9000	360 lbs.	110

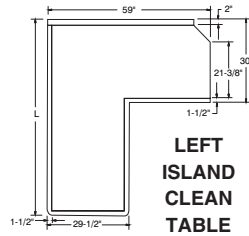

LEFT ISLAND CLEAN TABLE

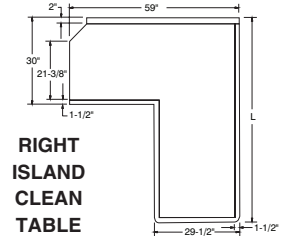

RIGHT ISLAND CLEAN TABLE

### U-SHAPED SOIL DISHTABLES

Nominal Size	Length	Model #	Price	Approx. Weight	Approx. Cu. Ft.
6 Ft.	71"	DTS-U30-72LorR	\$16491	450 lbs.	99
7 Ft.	83"	DTS-U30-84LorR	16809	470 lbs.	114
8 Ft.	95"	DTS-U30-96LorR*	17454	490 lbs.	130
9 Ft.	107"	DTS-U30-108LorR*	17904	525 lbs.	145
10 Ft.	119"	DTS-U30-120LorR*	18358	550 lbs.	160
11 Ft.	131"	DTS-U30-132LorR*	18648	575 lbs.	176
12 Ft.	143"	DTS-U30-144LorR*	18966	600 lbs.	192

\*Includes Field Joint (To be welded in field by others)

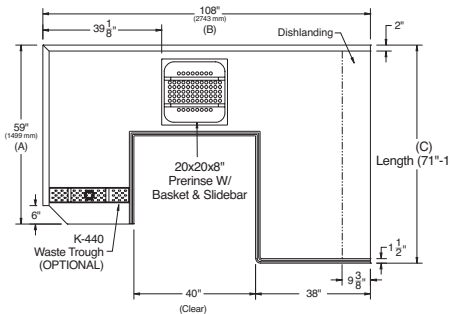

- Includes Prerinse sink basket and bar slide and dishlanding.
- Additional length on any leg of dishtables, use DTA-56 \$301 per ft. (Field joint may be required)
- Additional custom lengths available on all sides.
- If any 2 sides are larger than 90°, a welded field joint is required (WELDED BY OTHERS). USE K-57 \$391.
- For additional accessories and modifications, see pages 88-90. Dishlanding may be replaced with backsplash or rolled edge at no additional charge.

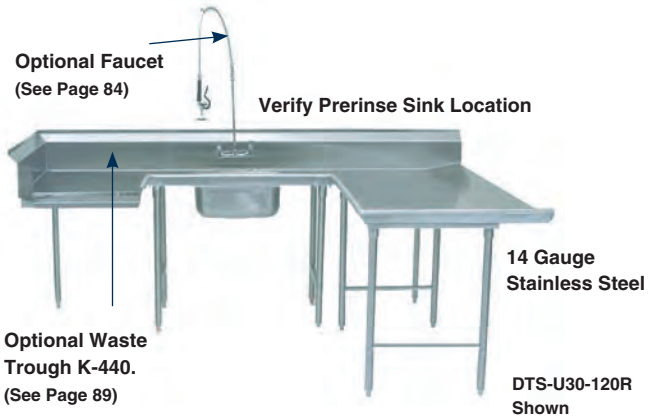

#### Prerinse Basket with Welded Slide Bar

All Stainless Steel  
Type 304 Series  
Perforated Basket for  
3/4" Radius Bowls

Model #	Size	Price
DTA-100	19 1/2" x 19 1/2"	\$905
	12 lbs. 1 Cu. Ft.	



4" Depth

#### Prerinse Slide Bar

Model #	Size	Price
DTA-60	19 1/2" x 19 1/2"	\$520
	9 lbs. 1 Cu. Ft.	

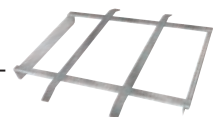

# DISHTABLES

## Specialty Dishtables

Faucets Can Be Found  
On Page 90

**ATTENTION:**  
See Dish Machine Information on  
Pg. 83 to ensure proper compatibility

## DISHTABLE WITH 3 COMPARTMENT BOWLS



Multiple Bowl Choices & Lengths

• 16 Gauge Stainless Steel • Stainless Steel Legs and Cross Rails • Stainless Steel Bullet Feet



DTC93-2020-8R Shown

### DEEP DRAWN BOWLS

Model #	Price	Length	Bowl Size	Drainboard Size	Approx. Weight
DTC93-1620-6LorR	<b>\$8224</b>	72"	16" x 20" x 12"	4"	200 lbs.
DTC93-1620-7LorR	<b>8562</b>	84"	16" x 20" x 12"	16"	220 lbs.
DTC93-1620-8LorR	<b>8840</b>	96"	16" x 20" x 12"	28"	240 lbs.
DTC93-1620-9LorR	<b>9295</b>	108"	16" x 20" x 12"	40"	275 lbs.
DTC93-2020-8LorR	<b>9230</b>	96"	20" x 20" x 12"	16"	260 lbs.
DTC93-2020-9LorR	<b>9683</b>	108"	20" x 20" x 12"	28"	310 lbs.
DTC93-2020-10LorR	<b>9996</b>	120"	20" x 20" x 12"	40"	310 lbs.

**BOWLS ARE LOCATED 12" IN FROM MACHINE**

For Other Configurations, Contact Factory

(Must Verify Machine For Control Box Or Drive Unit Interference)



DTC-3-1620-84L Shown

### FABRICATED BOWLS

Model #	Price	Length	Bowl Size	Drainboard Size	Approx. Weight
DTC-3-1620-66LorR	<b>\$8939</b>	66"	16" x 20" x 12"	12"	200 lbs.
DTC-3-1620-84LorR	<b>9306</b>	83"	16" x 20" x 12"	23"	220 lbs.
DTC-3-1620-96LorR	<b>9609</b>	95"	16" x 20" x 12"	35"	240 lbs.
DTC-3-1620-120LorR	<b>10869</b>	119"	16" x 20" x 12"	59"	265 lbs.
DTC-3-1620-144LorR	<b>11380</b>	143"	16" x 20" x 12"	83"	290 lbs.
DTC-3-1824-144LorR	<b>11882</b>	143"	18" x 24" x 14"	77"	365 lbs.
DTC-3-2020-96LorR	<b>10031</b>	95"	20" x 20" x 12"	23"	260 lbs.
DTC-3-2020-108LorR	<b>10525</b>	107"	20" x 20" x 12"	35"	285 lbs.
DTC-3-2020-120LorR	<b>10864</b>	119"	20" x 20" x 12"	48"	310 lbs.
DTC-3-2020-144LorR	<b>11803</b>	143"	20" x 20" x 12"	71"	340 lbs.
DTC-3-2424-144LorR*	<b>12322</b>	143"	24" x 24" x 14"	59"	380 lbs.

\* Requires Two Faucets

For Upgrade To 14 Gauge Use "DTA-49" \$862

### PRERINSE BASKETS & WELDED SLIDE BARS

#### Prerinse Baskets with Slide Bar

Model #	Fits Bowls	Price	Wt.	Cu.
DTA-125	16" x 20" x 4"	<b>\$790</b>	9 lbs.	1
DTA-100	20" x 20" x 4"	<b>905</b>	12 lbs.	1
Large Size Baskets				
DTA-58	18" x 24" x 4"	<b>1154</b>	11 lbs.	1
DTA-59	24" x 24" x 4"	<b>1315</b>	20 lbs.	1



DTA-100  
Shown

#### Prerinse Slide Bars

Model #	Fits Bowls	Price	Wt.	Cu.
DTA-64	16" x 20"	<b>\$448</b>	7 lbs.	1
DTA-60	20" x 20"	<b>520</b>	9 lbs.	1
Large Size Prerinse Slide Bars				
DTA-51	18" x 24"	<b>655</b>	8 lbs.	1
DTA-52	24" x 24"	<b>778</b>	10 lbs.	1

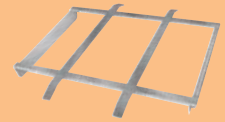

Prerinse Baskets & Slide Bar For Deep Drawn Bowls, See Page 87

### UNDERCOUNTER DISHTABLE

20" x 20" x 5"  
Sink Bowl

Length	Model #	Price	Approx. Weight	Approx. Cu. Ft.
48"	DTU-U60-48LorR	<b>\$4008</b>	80 lbs.	17
60"	DTU-U60-60LorR	<b>4221</b>	95 lbs.	19
72"	DTU-U60-72LorR	<b>4390</b>	115 lbs.	23

Left Or Right Designation Is Determined By Sink Location.

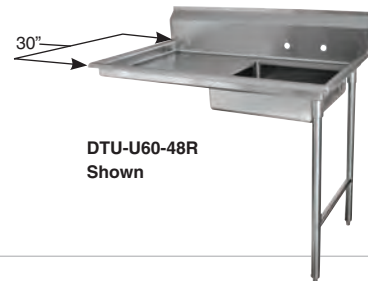

DTU-U60-48R  
Shown



### STAINLESS STEEL CONDENSATE HOODS



8" x 10" vent opening.  
Collar is centered 2" in height.

Model #	Length	Width	Height	Price
CH-3636	36"	36"	20"	<b>\$6054</b>
CH-4242	42"	42"	20"	<b>6519</b>
CH-4848	48"	48"	20"	<b>7216</b>
CH-61	Specify Alternate Collar Location			<b>254</b>
CH-56	Additional Length Or Width			<b>741 /lin. Ft.</b>

This Item Is Not UL Or NFPA Listed.

### VENT RISER

- Type 300 Stainless Steel
- Adjustable Ceiling Trim Collar
- Accommodates Standard 4" x 16" Vent Hood Duct

(Custom Sizes Available - Consult Factory)

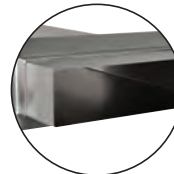

View of Opening

Model #	Length	Width	Height	Price
VR-1	16"	4"	60"	<b>\$2888</b>

This Item Is Not UL Or NFPA Listed.



# DISHTABLE MODS

## Dishtable Modifications & Accessories

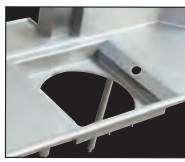

DTA-95

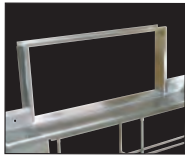

DTA-87



DTA-82



DTA-45

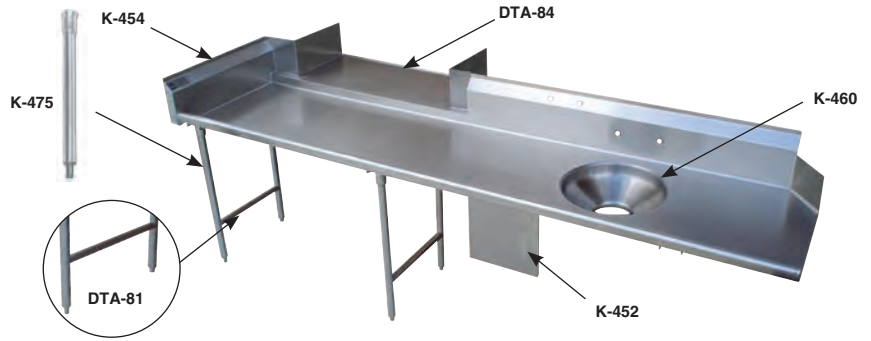

### MODIFICATIONS

K-23	Dishtable Legs Welded To Undershelf Or Left-To-Right Cross Rails, Shipped Set Up & Crated. (Top Is Not Welded To Legs)	\$561 /sink
K-23A	Dishtable Legs Welded To Leg Gussets Under Sink Top & To Undershelf Or Left-To-Right Cross Rails, Shipped Set Up & Crated	741 /sink
K-24	Shell Crating	433
K-37	Anti-Siphon Vacuum Breaker Hole	168
K-57	Welded Field Joint (Welded In Field By Others)	391
K-76	Paint On Sound Deadening	746 /sink
K-77	Splash Cut-Out (Pipe Chase)	265
K-440	Waste Trough Installation Welded Into Table And Furnished With A 2" Deep Removable Basket	1277
K-452	Control Bracket 8" x 12"	373 ea.
K-453	Control Bracket 14" x 16"	400 ea.
K-454	Side Splash	581 ea.
K-456	Scrap Block Installed (Includes Rubber Scrap Block)	546 ea.
K-460	Disposal Cone Welded Into Table And Furnished With 8" x 12" Control Bracket & Faucet Holes (Supplied By Others)	1115
K-460A	Installation Of Disposal Cone With 14" x 16" Control Bracket, Faucet Holes (Cone Supplied By Others)	1184
K-461	Disposal Collar Welded Into Sink Bowl And Furnished With 8" x 12" Control Bracket (Supplied By Others)	1115
K-461A	Disposal Collar Welded Into Sink Bowl And Furnished With 14" x 16" Control Bracket (Supplied By Others)	1184
K-472	Special Faucet Hole Location	176 ea.
K-495	Turn Down Backsplash (Incl. 2 Brackets. See K-397 For Add'l Sets)	233
K-508A	Special Modification Charge	355
K-550	Stainless Steel Tubular Rack Storage	279 lin. ft.

DTA-40	Drain Hole (For Sorting Table)	\$191
DTA-45	Scrap Trough Welded To Dump Sink - Min. Scrap Trough Length Is 3'. Max. Length Is 8'. For 20" x 20" x 8" Bowl Spec-Line Soil S30 Series Only. - Consult Factory For Trough Lengths Exceeding 8 Feet	505 lin. ft.
DTA-46	Inside Mitered Corner	751
DTA-66	Provision For Dishlanding On Straight Soil Table (Min 4")	369 /lin. Ft.
DTA-70	Install Booster Heater Brackets (Brackets By Others)	237
DTA-72	Provision For Side Loader	1538
DTA-75	Provision For Limit Switch (Limit Switch By Others)	270
DTA-76	Move Prerinse Sink To Conform To Dishmachine Requirements. Please Specify Machine When Placing Order	N/C
DTA-78	Notch In Backsplash Return To Clear Handle Please Specify Machine When Placing Order	204
DTA-81	S/S Welded Leg Assembly with S/S Feet	431 /bowl
DTA-82	15" x 20" x 8" Undercounter Dump Sink	3631 /bowl
DTA-84	Simple Pass-Thru (Specify Wall Thickness - Min. Length 36")	895 /Ft.
DTA-87	Pass-Thru Wall Frame (Specify Wall Thickness - Min. Length 36")	512 /lin. Ft.
DTA-95	Install Scrapper Top	2473
DTA-96	Install Trough Collector	3043
DTA-99A	16" x 20" x 12" Sink Bowls	1912 /bowl
DTA-99B	20" x 20" x 12" Sink Bowls	2054 /bowl
DTA-99C	10" x 14" x 5" Dump Sink	1636 /bowl
DTA-99D	18" x 24" x 14" Sink	2244 /bowl
DTA-99E	24" x 24" x 14" Sink	2390 /bowl
DTA-106	Mirror Highlight To Dishtable Upgrade	590

### ACCESSORIES

K-4	Lever Drain Bracket	\$189
K-5	Twist Handle Operated Drain	388
K-15	Twist Handle Operated Drain With Overflow	712
K-397	Wall Brackets (2 Each. Brackets Included With K-495)	119 /set
K-455C	Stainless Steel Sink Cover 16" x 20"	691
K-455E	Stainless Steel Sink Cover 20" x 20"	691
K-457	Replacement Rubber Scrap Block (See K-456 For Install Cost)	166 ea.
K-475	Replacement S/S Leg With Stainless Steel Bullet Foot	100 ea.
K-478	Replacement Stainless Steel Bullet Foot	40 ea.
K-488	Flanged S/S Bullet Foot	85 ea.
K-550	Stainless Steel Tubular Rack Storage	279 /lin. Ft.
K-610	Perforated Stainless Steel Sink Grid (Specify Bowl Size)	1066 ea.
K-700D	12" High Removable Side Splash For Dishtables (Specify Model)	674 ea.
DTA-53	SPEC-LINE Heavy Duty Prerinse Faucet	1266
DTA-51	Pre-Rinse Slide Bar for 18" x 24" Fab. Sink Bowls	655

DTA-52	Pre-Rinse Slide Bar for 24" x 24" Fab. Sink Bowls	\$778
DTA-55	Column Notch (Includes Splash)	1066
DTA-56	Add'l Length On 59" Side Of Corner Or Straight Tables	301 /lin. Ft.
DTA-58	Pre-Rinse Basket w/ Slide Bar for 18" x 24" Fab. Sink Bowls	1154
DTA-59	Pre-Rinse Basket w/ Slide Bar for 24" x 24" Fab. Sink Bowls	1315
DTA-60	Prerinse Slide Bar for 20" x 20" Fab. Sink Bowls	520
DTA-62	Prerinse Basket For 20" x 20" Deep Drawn Bowls	1135
DTA-63	Prerinse Slide Bar For 20" x 20" Deep Drawn Bowls	520
DTA-64	Prerinse Slide Bar For 16" x 20" Fab. Sink Bowls	448
DTA-65	Prerinse Slide Bar For 16" x 20" Deep Drawn Bowls	448
DTA-67	Stainless Steel Rear Cross-Bracing (Factory Installed Only)	50 /lin. Ft.
DTA-69	Prerinse Basket For 16" x 20" Deep Drawn Bowls	1080
DTA-100	Prerinse Basket with Slide Bar for 20" x 20" Fab. Sink Bowls	905
DTA-125	Prerinse Basket with Slide Bar for 16" x 20" Fab. Sink Bowls	790
DTA-125A	Prerinse Scrap Basket For DTA-82 Undermount Dump Sink	1056

# Dishtables

## Dishtable Faucets & Accessories

 = Ships via UPS

### SPEC-LINE EXTRA HEAVY DUTY 14" Splash Mounted Swing Spout Faucet



8" O.C.

**K-105 \$704** 

T&S Equivalent Model # B231

 Splash Mounted  
Prerinse Faucet

**K-116 \$1758** 

 12" Add-A-Faucet

**K-117-TS \$771**

(Fits K-116 Only) 

### Prerinse Faucets

Prerinse Features:

- 8" O.C.
- Wall Bracket
- Continuous Spray Ring
- Heavy Duty Chrome Plated Spring

SPEC-LINE  
HEAVY DUTY  
Splash Mounted

**DTA-53 \$1266** 

T&S Equivalent

Model # B133-B

12" Add-A-Faucet

**K-117 \$495**

(Fits DTA-53 Only)



### Table Mounted SORTING SHELVES



Mounts to backsplash and end roll of dishtable  
(D, G and U-shaped Dishtables only)

Shelf Shipped Separate From Table To Reduce Freight  
Costs And Chance Of Shipping Damage.



New Versatile Design allows for  
Different Glass Rack Applications

- Drip Tubes For Water Drainage
- 14 Gauge End Plates
- 18 Gauge, 1 5/8" Tubes

**DTA-79 \$671 /lin. Ft.**



- Drip Tubes For Water Drainage
- 14 Gauge End Plates & Base
- 18 Gauge, 1 5/8" Tube

**DTA-79S \$853 /lin. Ft.**

### STAINLESS STEEL UNDERSHELVES

Additional Storage

Shelving Is Reversible (Left Or Right)



Size Undershell To Be At Least  
6" Shorter Than Dishtable.

Now With Stainless Steel Legs!

Length	Model #	Price	Approx. Wt.	Approx. Cubes
18"	DTA-SS-18	\$633	11 lbs.	1
24"	DTA-SS-24	722	13 lbs.	1
30"	DTA-SS-30	762	15 lbs.	1
42"	DTA-SS-42	812	20 lbs.	2
54"	DTA-SS-54	926	23 lbs.	2
66"	DTA-SS-66	1044	30 lbs.	3
78"	DTA-SS-78	1107	35 lbs.	3
90"	DTA-SS-90	1180	39 lbs.	4
102"	DTA-SS-102	1338	45 lbs.	5
114"	DTA-SS-114	1394	50 lbs.	5
126"	DTA-SS-126	1643	55 lbs.	6
138"	DTA-SS-138	1714	59 lbs.	6

### SORTING SHELVES

Traditional Design

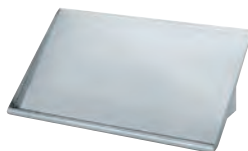

KD Tubular Design



FOR TABLE MOUNTED, ADD DTA-88 \$851

Length	Model #	Racks	Price	Approx.		Length	Model #	Racks	Price	Approx.	
				Wt.	Cubes					Wt.	Cubes
22"	DT-6R-11	1	\$1821	20 lbs.	1	22"	DT-6R-21	1	\$1356	15 lbs.	1
42"	DT-6R-12	2	1948	30 lbs.	2	42"	DT-6R-22	2	1530	23 lbs.	2
62"	DT-6R-13	3	2046	40 lbs.	4	62"	DT-6R-23	3	1631	30 lbs.	4
82"	DT-6R-14	4	2180	50 lbs.	5	82"	DT-6R-24	4	1733	38 lbs.	5

### SORTING TABLES

16 Gauge 304 Stainless Steel • 3" Raised Edge  
**STAINLESS STEEL CROSS BRACING ON ALL SIDES**

#### Standard

Model #	Price	Size	Approx. Wt.	Approx. Cubes
SR-48	\$2966	48" x 30"	84 lbs.	12
SR-60	3138	60" x 30"	98 lbs.	15
SR-72	3313	72" x 30"	109 lbs.	18
SR-96	3704	96" x 30"	143 lbs.	21





Shown With  
Optional Casters

#### 10 1/2" Backsplash

Model #	Price	Size	Approx. Wt.	Approx. Cubes
BSR-48	\$2999	48" x 30"	88 lbs.	12
BSR-60	3161	60" x 30"	103 lbs.	15
BSR-72	3331	72" x 30"	115 lbs.	18
BSR-96	3830	96" x 30"	150 lbs.	21



-  TA-255 Super Heavy Duty Casters ..... \$791
- DTA-40 Drain Hole ..... 191

 **WARNING:** Faucets on this page may contain a chemical known to the State of California to cause cancer, birth defects or other reproductive harm.

# Underbar Basics™

## Featuring New Extended Widths!

Sinks, Blender Stations, Drainboards & Liquor Racks now have a new flush design for a clean, linear appearance when adding SRK Speed Rails.



### Features and Benefits

- 18", 21", 23" & 26" Widths
- 4" Backsplash
- All Units Come with 4 Galvanized Legs w/ Adjustable Plastic Bullet Feet
- Selected Models Feature Adjustable Galvanized Cross-Bracing (Front to Back)
- Embossed & Seamless Drainboards (Where Applies)
- Blender Stations Include Hidden Duplex Electrical Outlet



# UNDERBAR DROP-INS



## Drop-In Ice Bins, Water Stations & Hand Sinks

### DROP-IN WATER STATIONS

Includes K-54 Deck Mount Faucet With "Push-Back" Acrylic Lever Arm



Ice Bin Inside Dim.:  
8" x 13 1/2" x 10 13/16"  
Ice Capacity: 23 lbs.

Ice Bin Inside Dim.:  
13 1/2" x 18 3/4" x 10 13/16"  
Ice Capacity: 50 lbs.

### Underbar Basics™

For Custom Cut-Out Use  
Model # TA-34 \$355



Overall Size:  
12" x 14"

#### D-24-WSIBL \$1969

Removable Grate Covers Drip Pan  
13" Deep Insulated Ice Bin w/ S/S Steel Cover  
1" IPS Drain  
Outside Dim. 21" x 18"  
Cut-Out Size: 20 5/8" x 15 1/4"  
30 lbs. 5 cu. Ft.

#### D-24-WSIBL2 \$2355

Removable Grate Covers Drip Pan  
13" Deep Insulated Ice Bin w/ S/S Steel Cover  
1" IPS Drain  
Outside Dim.: 18" x 21"  
Cut-Out Size: 15 1/4" x 20 5/8"  
47 lbs. 5 cu. Ft.

Add A 7-Circuit Cold Plate  
To D-24-WSIBL2  
Add SU-49 \$2584

#### DI-1-9 \$1466

Removable Electro-Polished  
Stainless Steel Grill  
1 1/2" IPS Basket Drain  
Cut-Out Size: 11 1/4" x 13 1/4"  
15 lbs. 3 cu. Ft.

### DROP-IN BAR HAND SINKS

Featuring Deep Drawn Sink Bowls



Overall Size:  
13" x 19"



Overall Size:  
12" x 14"



Hand Sink Bowl Size:  
9" x 9" x 4"

Ice Bin Inside Dim.:  
8" x 13 1/2" x 10 13/16"

Ice Capacity: 23 lbs.

#### DI-1-5 \$825

K-52 Deck Mounted Faucet  
1 1/2" IPS Basket Drain  
Cut-Out Size: 12 1/4" x 18 1/4"  
20 Gauge Stainless Steel  
12 lbs. 2 cu. Ft.

#### DI-1-25 \$919

K-52 Deck Mounted Faucet  
1 1/2" IPS Basket Drain  
Cut-Out Size: 11 1/4" x 13 1/4"  
20 Gauge Stainless Steel  
8 lbs. 2 cu. Ft.

#### D-24-SIBL \$2104

K-51 Deck Mounted Faucet  
Insulated Ice Bin w/ S/S Cover  
1" IPS Drain In Ice Bin  
Outside Dim.: 21" x 18"  
Cut-Out Size: 20 5/8" x 15 1/4"  
Factory Installed Only  
20 Gauge Galvanized Steel  
30 lbs. 5 cu. Ft.

For Our Full Line Of Drop-in Sinks, See pages 3-5

## ACCESSORIES & MODIFICATIONS

### Replacement Sliding Stainless Steel Covers

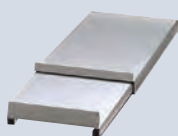

D-12  
Shown

Model #	Price	For Use With:
D-12	\$134	D-12-IBL, D-24-WSIBL, D-24-WSIBL2, D-24-SIBL
D-24	153	D-24-IBL, D-24-IBL-7
D-24V	173	D-24-IBL, D-24-IBL-7
D-30	218	Units oriented with 18" dimension left-to-right D-30-IBL, D-30-IBL-7
D-36	248	D-36-IBL, D-36-IBL-7

Cover designed to open front-to-rear, with 18" ice bin dimension front-to-rear.  
(D-24-WSIBL2 opens left to right when installed with 21" front-to-rear)



Add Wrist Handles  
K-316-LU  
\$167



6" Deck  
Mounted Faucet  
K-51 \$663  
4" O.C.

### Water Filler Faucets



K-54 8-1/4" High \$744  
K-54A 12" High \$845  
K-54OMIT -\$420  
Omit K-54 Faucet



3 1/2" Gooseneck  
Deck Mounted Faucet  
K-52 \$331



# UNDERBAR DRAIN PANS

## Drop-In Ice Bins, Bar Sinks & Drain Pans

Underbar **Basics™**

### DROP-IN ICE BINS

11" Deep Insulated Ice Bin w/ Sliding Stainless Steel Cover

- Rubber Thermal Breaker Reduces Condensation
- Optional 7-Circuit Cold Plate Sealed Into The Bottom

Model #	Price	Overall Length	Cut Out Size W x L	Ice Capacity	Approx. Weight	Approx. Cu. Ft.
D-12-IBL	\$1579	12"	15 1/4" x 9 5/8"	23 lbs.	22 lbs.	3
D-24-IBL	1731	21"	15 1/4" x 20 3/8"	50 lbs.	39 lbs.	5
D-30-IBL	1752	27"	15 1/4" x 26 3/8"	62 lbs.	62 lbs.	8
D-36-IBL	1957	33"	15 1/4" x 32 3/8"	75 lbs.	67 lbs.	9
w/ 7-CIRCUIT COLD PLATE						
D-24-IBL-7	3941	21"	15 1/4" x 20 3/8"	50 lbs.	84 lbs.	9
D-30-IBL-7	3991	27"	15 1/4" x 26 3/8"	62 lbs.	107 lbs.	13
D-36-IBL-7	4178	33"	15 1/4" x 32 3/8"	75 lbs.	113 lbs.	15

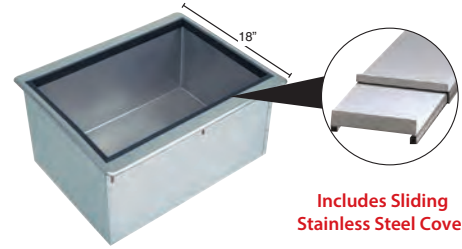

Includes Sliding Stainless Steel Cover

For Replacement Sliding Stainless Steel Covers, See Page 92.

### DROP-IN BAR SINKS

Optional Built-in Embossed Drainboard

- 10" x 14" x 10" Sink Bowls
- 9" High Overflow Pipe(s) w/ 1 1/2" IPS Drain(s)
- 4" O.C. Deck Mounted Swing Faucet
- 4" O.C. Deck Mounted Faucet

Model #	Price	# of Bowls	# of Drbds.	Drbd. Size	Drbd. Location	Outside Dim. W x L	Cut Out Size W x L	Approx. Weight	Approx. Cu. Ft.
DBS-1	\$1208	1	0	N/A	N/A	13" x 19"	12 1/4" x 18 1/4"	21 lbs.	3
DBS-2	1355	2	0	N/A	N/A	25 1/2" x 19"	24 3/4" x 18 1/4"	26 lbs.	4
DBS-3	1631	3	0	N/A	N/A	38" x 19"	37 1/4" x 18 1/4"	42 lbs.	9
DBS-43L	2457	3	1	12"	Right	21 1/8" x 48 5/16"	17" x 47"	88 lbs.	10
DBS-43R	2457	3	1	12"	Left	21 1/8" x 48 5/16"	17" x 47"	88 lbs.	10
DBS-53C	2675	3	2	12"	Left & Right	21 1/8" x 60 5/16"	17" x 59"	100 lbs.	21
DBS-63C	2793	3	2	18"	Left & Right	21 1/8" x 72 5/16"	17" x 71"	110 lbs.	24

L and R Indicate Sink Location. C Indicates Sink is Centered.



DBS-1

DBS-53C shown

### 18" WIDE COUNTERTOP DRAIN PAN

- Removable Drip Tray
- Stainless Steel Top
- 1/2" NPT Drain

**CUSTOM SIZES AVAILABLE**  
Consult Factory For Details

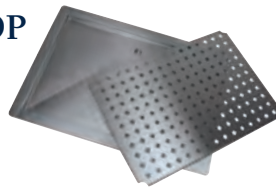

Model #	Price	Size W x L	Cut Out Size	Approx. Weight	Approx. Cu. Ft.
DP-1818	\$1113	18" x 18"	15 3/4" x 15 3/4"	18 lbs.	2
DP-1824	1137	18" x 24"	15 3/4" x 21 3/4"	23 lbs.	2
DP-1830	1162	18" x 30"	15 3/4" x 27 3/4"	28 lbs.	3
DP-1836	1202	18" x 36"	15 3/4" x 33 3/4"	33 lbs.	3
DP-1842	1293	18" x 42"	15 3/4" x 39 3/4"	38 lbs.	4
DP-1848	1394	18" x 48"	15 3/4" x 45 3/4"	43 lbs.	4

### BAR DRINK RAILS

- Type 300 Stainless Steel
- 8" Wide (Front To Back) x 3/4" Deep
- Perforated Removable Grate Allows For Easy Cleaning
- 1" Drain On Right Side
- Designed To Secure To Underside Of Wood Substrate



#### OPTIONS

- DRKC-45-IC  
45° Inside Corner
- DRKC-45-OC  
45° Outside Corner  
**\$752 ea.**
- DRKC-90-IC  
90° Inside Corner
- DRKC-90-OC  
90° Outside Corner  
**\$752 ea.**

Model #	Price	Size W x L	Approx. Weight	Approx. Cu. Ft.
DRKR-12	\$404	8" x 12"	10 lbs.	2
DRKR-18	449	8" x 18"	15 lbs.	2
DRKR-24	473	8" x 24"	20 lbs.	2
DRKR-30	543	8" x 30"	25 lbs.	2
DRKR-36	602	8" x 36"	30 lbs.	3
DRKR-42	682	8" x 42"	35 lbs.	3
DRKR-48	767	8" x 48"	40 lbs.	3

### COUNTERTOP GLASS RINSER

Rinses away any impurities that might be in the glass!

- Mounts Easily to countertop or bar equipment
- Brushed Stainless Steel
- Water Rinsers And Glass Actuator By Pushing Down On Glass
- Threaded Drain For 1/2" Drain Hose

**FACTORY INSTALLED ONLY**

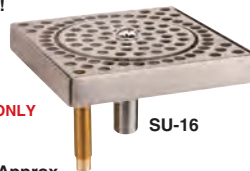

SU-16

Model #	Price	Size	Approx. Wt	Approx. Cu. Ft.
SU-16	\$993	6 3/8" x 6 3/8" x 3/4"	7 lbs.	1

### GLASS RINSER FOR PERFORATED DRAINBOARDS (Activator Only) **FACTORY INSTALLED ONLY**

SU-16P	\$993	4 1/4" Diameter	3 lbs.	1
--------	-------	-----------------	--------	---



SU-16P

### UNDERCOUNTER GLASS RINSER

Rinses away any impurities that might be in the glass!

- Mounts Easily to Underside Of Wood Substrate
- Brushed Stainless Steel
- Retrofit any liquid dispense station
- Water Rinsers And Glass Actuator By Pushing Down On Glass
- Threaded Drain For 1/2" Drain Hose



SU-16UM

Model #	Price	O.A. W x L x H	Rinsers Size W x L x H	Approx. Wt	Approx. Cu. Ft.
SU-16UM	\$1316	6 3/8" x 11 3/8" x 1"	6-3/8" x 6-3/8" x 1"	8 lbs.	1

**WARNING:** Faucets on this page may expose you to chemicals, including lead, that are known to the State of California to cause cancer or birth defects or other reproductive harm. For more info, visit [www.p65warnings.ca.gov](http://www.p65warnings.ca.gov).

# BAR HAND SINKS

## Free Standing Bar Hand/Dump Sinks

Underbar **Basics™**



### BAR HAND SINKS

Bowl Size: 10" x 14" x 10" • 29" Working Height • 4" High Backsplash  
Includes 1-1/2" IPS Drain & Galvanized Legs w/ Adjustable Galvanized Side Cross-Bracing & Adjustable Plastic Bullet Feet  
Add SU-10A For Stainless Steel Leg & Stainless Steel Bullet Foot Upgrade w/ Front-to-Back Cross-Bracing **\$360**



#### 18" Wide Units

- 4" O.C. Splash Mounted Swing Spout Faucet

Model #	Price	Overall Length	Approx. Weight	Approx. Cu. Ft.
SL-HS-12	<b>\$1337</b>	12"	31 lbs.	5
SL-HS-15	<b>1419</b>	15"	34 lbs.	6



#### 21" Wide Units

- 4" O.C. Deck Mounted Swing Spout Faucet
- Rear Deck For Extra Storage

Model #	Price	Overall Length	Approx. Weight	Approx. Cu. Ft.
CR-HS-12	<b>\$1385</b>	12"	32 lbs.	6
CR-HS-15	<b>1458</b>	15"	35 lbs.	6

## HAND SINKS w/ BUILT-IN SOAP & TOWEL DISPENSERS

Bowl & Faucet • 29" Working Height • 4" High Backsplash  
Includes 1 1/2" IPS Basket Drain & Galvanized Legs w/ Adjustable Galvanized Side Cross-Bracing & Adjustable Plastic Bullet Feet  
Add SU-10C For Stainless Steel Leg & Stainless Steel Bullet Foot Upgrade w/ Front-to-Back Cross-Bracing **\$360**



#### 21" Wide Standard Units

- 4" O.C. Deck Mounted Swing Spout Faucet
- Rear Deck For Extra Storage

Model #	Price	Overall Length	Approx. Weight	Approx. Cu. Ft.
SC-12-TS	<b>\$1733</b>	12"	45 lbs.	4
SC-15-TS	<b>1777</b>	15"	49 lbs.	4



#### 21" Wide Side Splash Units

- 4" O.C. Deck Mounted Swing Spout Faucet
- 4" High Stainless Steel Side Splashes
- Rear Deck For Extra Storage

Model #	Price	Overall Length	Approx. Weight	Approx. Cu. Ft.
SC-12-TS-S	<b>\$2169</b>	12"	50 lbs.	4
SC-15-TS-S	<b>2219</b>	15"	54 lbs.	4

**18" Wide Units Available - Consult Factory**

## HAND SINK ACCESSORIES & MODIFICATIONS



#### Add Wrist Handles

K-316-LU **\$167**

For Deck & Splash Mount Faucets



#### Replacement Deck Mount Soap Dispenser

K-12 **\$211**



#### Chrome Towel Ring

A-15 **\$136** Packed Loose



#### Replacement 6" Splash

Mount Faucet

K-125 **\$432**

4" O.C. 6" Spout

#### Add A Side Splash

SU-18R or L **\$229**

SU-18RL **\$463**

For 21" Wide Units

SU-21R or L **\$250**

SU-21RL **\$495**



#### Stainless Steel Leg Upgrade

- Includes 2 Sets of (2) S/S Legs w/ Adjustable S/S Bullet Feet & Adjustable S/S Front-to-Back Cross-Bracing

- Leg Heights Do Not Include 1 1/4" Bullet Foot Height

SU-10A **\$360** 18" Legs

SU-10C **\$360** 14" Legs



#### Replacement 6" Deck

Mount Faucet

K-51 **\$663**

4" O.C. 6" Spout

For Our Full Line Of Modifications & Accessories, See Page 118-120.



### BAR SINKS

w/ 10" x 14" x 10"

- 4" High Backsplash
- 29" working Height
- Molded Apron For Extra Durability
- Each Sink Bowl Includes an Overflow Pipe w/ 1 1/2" IPS Drain
- Galvanized Legs w/ Adjustable Galvanized Side Cross-Bracing & Adjustable Plastic Bullet Feet
- **SLB Series** Includes 1 - 4" O.C. Splash Mounted Swing Spout Faucet
- **CRB Series** Includes 1 - 4" O.C. Deck Mounted Swing Spout Faucet & Has Rear Deck For Extra Storage
- **4 Comp. Sinks** Include Two 6" Swing Spout Faucets



**SLB Series**  
18" Wide Units With  
Splash Mount Faucet



**CRB Series**  
21" Wide Units With  
Deck Mount Faucet

L And R Indicate Sink Location. C Indicates Sink Is Centered.

	SPLASH MOUNT FAUCET				DECK MOUNT FAUCET				O.A. Length	# of Drbds.	Drbd. Length	Approx. Cu. Ft.
	18" WIDE	Price	Spout Size	Approx. Wt.	21" WIDE	Price	Spout Size	Approx. Wt.				
<b>1 COMP.</b>	SLB-31C	\$2031	6"	55 lbs.	CRB-31C	\$2239	6"	55 lbs.	36"	2	12"	13
<b>2 COMP.</b>	SLB-22C	2145	6"	54 lbs.	CRB-22C	2309	6"	54 lbs.	24"	0	N/A	8
	SLB-32LorR	2277	6"	57 lbs.	CRB-32LorR	2429	6"	57 lbs.	36"	1	9"	13
	SLB-42LorR	2333	6"	62 lbs.	CRB-42LorR	2500	6"	62 lbs.	48"	1	21"	15
	SLB-42C	2333	6"	66 lbs.	CRB-42C	2520	6"	66 lbs.	48"	2	12"	15
<b>3 COMP.</b>	SLB-33C	2460	10"	65 lbs.	CRB-33C	2628	12"	65 lbs.	36"	0	N/A	13
	SLB-43LorR	2586	10"	68 lbs.	CRB-43LorR	2767	12"	68 lbs.	48"	1	9"	15
	SLB-53C	2721	10"	76 lbs.	CRB-53C	2913	12"	76 lbs.	60"	2	12"	18
	SLB-63C	2869	10"	88 lbs.	CRB-63C	3070	12"	88 lbs.	72"	2	18"	22
	SLB-73C	3190	10"	162 lbs.	CRB-73C	3413	12"	170 lbs.	84"	2	24"	39
<b>4 COMP.</b>	SLB-83C	3486	10"	183 lbs.	CRB-83C	3741	12"	191 lbs.	96"	2	30"	44
	SLB-64C*	3387	6"	92 lbs.	CRB-64C*	3608	6"	92 lbs.	72"	2	12"	22
	SLB-74C*	3603	6"	164 lbs.	CRB-74C*	3853	6"	172 lbs.	84"	2	18"	39
	SLB-84C*	3915	6"	185 lbs.	CRB-84C*	4169	6"	193 lbs.	96"	2	24"	44

\*4 Comp. Bar Sinks Include 2 - 6" Swing Spout Faucets

### BAR SINK & ICE BIN COMBO

With Removable Plastic Bottle Racks

- 4" Backsplash
- 29" Working Height
- Three or Four Compartment - 10" x 14" Bowls
- Each Sink Bowl Includes Overflow Pipe & 1-1/2" I.P.S. Drain
- Molded Apron For Extra Durability
- 24" x 15" x 8" Insulated Ice Bin; 54 lbs. Ice Capacity
- Ice Bin Includes 1" IPS Drain
- Galvanized Legs w/ Adjustable Galvanized Side Cross-Bracing & Adjustable Plastic Bullet Feet
- **SLC Series** Includes 1 - 4" O.C., 10" Splash Mounted Swing Spout Faucet
- **CRC Series** Includes 1 - 4" O.C., 12" Deck Mounted Swing Spout Faucet & Has Rear Deck For Extra Storage



SLC-83C-R

Add A 7-Circuit Cold Plate  
To SLC or CRC series  
Add SU-49 \$2584

L And R Indicates Ice Bin Location.

SPLASH MOUNT FAUCET		DECK MOUNT FAUCET		O.A. Length	# of Bowls	# of Drbds.	Drbd. Length	Approx. Weight	Approx. Cu. Ft.
18" WIDE	Price	21" WIDE	Price						
SLC-73C-LorR	\$3682	CRC-73C-LorR	\$3935	84"	3	2	12"	185 lbs.	28
SLC-83C-LorR	3817	CRC-83C-LorR	4070	96"	3	2	18"	225 lbs.	32
SLC-84C-LorR*	4274	CRC-84C-LorR*	4557	96"	4	2	12"	225 lbs.	32

\*4 Comp. Bar Sinks Include 2 - 6" Swing Spout Faucets

### BAR SINK MODIFICATIONS

#### Add A Side Splash

For 18" Wide Units  
SU-18R or L **\$229**  
SU-18RL **\$463**

For 21" Wide Units  
SU-21R or L **\$250**  
SU-21RL **\$495**

#### Stainless Steel Leg Upgrade



- Includes 2 Sets of (2) S/S Legs w/ Adj. S/S Bullet Feet & Adj. S/S Front-to-Back Cross-Bracing
- Leg Heights Do Not Include 1 1/4" Bullet Foot Ht.

SU-10A **\$360**  
18" Legs

For Our Full Line Of Speed Rails, See Page 101.

# ICE BINS

## Ice Bins

All Bottle Racks Must Be Removed For NSF Compliance & For Use With Optional Cover

Underbar **Basics™**

Quick Pour Bottles Not Included

### 12" or 16" Deep Insulated Ice Bins • 29" Working Height

- 4" Backsplash
- Includes Two Removable Plastic Bottle Racks
- Galvanized Legs w/ Adjustable Galvanized Side Cross-Bracing & Adjustable Plastic Bullet Feet
- **CRI Series** Has Rear Deck For Extra Storage
- Optional 7or 10 Circuit Cold Plate Sealed Into The Bottom



Ice Bin Depth	O.A.	Ice Bin Capacity	18" WIDE	Price	Approx. Wt.	21" WIDE	Price	Approx. Wt.	Approx. Cu. Ft.
<b>12" DEEP</b>	12"	35 lbs.	SLI-12-12	\$1462	46 lbs.	CRI-12-12	\$1484	50 lbs.	6
	24"	77 lbs.	SLI-12-24	1715	60 lbs.	CRI-12-24	1829	65 lbs.	8
	30"	98 lbs.	SLI-12-30	1895	68 lbs.	CRI-12-30	2079	72 lbs.	11
	36"	119 lbs.	SLI-12-36	2071	78 lbs.	CRI-12-36	2220	80 lbs.	12
	42"	140 lbs.	SLI-12-42	2167	84 lbs.	CRI-12-42	2311	90 lbs.	13
<b>16" DEEP</b>	48"	161 lbs.	SLI-12-48	2264	90 lbs.	CRI-12-48	2412	98 lbs.	14
	24"	100 lbs.	SLI-16-24	2196	69 lbs.	CRI-16-24	2361	72 lbs.	8
	30"	127 lbs.	SLI-16-30	2445	78 lbs.	CRI-16-30	2625	82 lbs.	12
36"	155 lbs.	SLI-16-36	2695	86 lbs.	CRI-16-36	2888	90 lbs.	17	
w/ 7-CIRCUIT COLD PLATE									
<b>12" DEEP</b>	24"	77 lbs.	SLI-12-24-7	3515	119 lbs.	CRI-12-24-7	3631	122 lbs.	8
	30"	128 lbs.	SLI-12-30-7	3697	133 lbs.	CRI-12-30-7	3826	136 lbs.	11
	36"	149 lbs.	SLI-12-36-7	3871	144 lbs.	CRI-12-36-7	4019	147 lbs.	13
	42"	170 lbs.	SLI-12-42-7	3966	157 lbs.	CRI-12-42-7	4110	163 lbs.	13
	48"	191 lbs.	SLI-12-48-7	4065	169 lbs.	CRI-12-48-7	4123	175 lbs.	14
<b>16" DEEP</b>	24"	100 lbs.	SLI-16-24-7	3993	128 lbs.	CRI-16-24-7	4159	136 lbs.	8
	30"	127 lbs.	SLI-16-30-7	4241	140 lbs.	CRI-16-30-7	4428	143 lbs.	12
	36"	155 lbs.	SLI-16-36-7	4499	153 lbs.	CRI-16-36-7	4690	59 lbs.	17
w/ 10-CIRCUIT COLD PLATE									
<b>12" DEEP</b>	30"	98 lbs.	SLI-12-30-10	5300	165 lbs.	CRI-12-30-10	4794	69 lbs.	11
	36"	119 lbs.	SLI-12-36-10	5696	177 lbs.	CRI-12-36-10	4927	181 lbs.	12
	42"	140 lbs.	SLI-12-42-10	4924	186 lbs.	CRI-12-42-10	5171	191 lbs.	13
	48"	161 lbs.	SLI-12-48-10	5133	201 lbs.	CRI-12-48-10	5357	206 lbs.	14
<b>16" DEEP</b>	30"	127 lbs.	SLI-16-30-10	5300	174 lbs.	CRI-16-30-10	5712	180 lbs.	12
	36"	155 lbs.	SLI-16-36-10	5696	185 lbs.	CRI-16-36-10	6049	192 lbs.	17

## INSULATED BOTTLE STORAGE BIN

### Featuring 12" Deep Insulated Ice Bin

- 4" Backsplash
- 29" working height
- Includes Two 3-Pack Plastic Bottle Racks
- Galvanized Legs w/ Adjustable Galvanized Side Cross-Bracing & Adjustable Plastic Bullet Feet
- 1" I.P.S. Drain

18" WIDE			21" WIDE					
Model #	Price	Approx. Weight	Model #	Price	Approx. Weight	L	Ice Bin Capacity	Approx. Cu. Ft.
SLI-12-12	\$1462	46 lbs.	CRI-12-12	\$1484	50 lbs.	12"	35 lbs.	6



SLI-12-12

## PORTABLE ICE BIN 16" Extra Deep For Beer Bottle Storage

- Insulated Ice Bin
- 29" working height
- Stainless Steel Welded Cross-Braced Legs w/ Casters (2 w/ Brakes)
- 1" IPS Drain w/ Shut Off Valve

Model #	Price	Size L x W x H	Ice Bin Capacity	Approx. Weight	Approx. Cu. Ft.
SCI-MIC-24	\$1986	24" x 18 3/4" x 29"	100 lbs.	120 lbs.	7
SCI-MIC-30	2072	30" x 18 3/4" x 29"	127 lbs.	130 lbs.	12
SCI-MIC-36	2225	36" x 18 3/4" x 29"	155 lbs.	145 lbs.	16

18 3/4" WIDE



## ICE BIN ACCESSORIES & MODIFICATIONS

### Sliding Stainless Steel Covers For Ice Bins

For SLI & CRI Series

SSC-12	For 12" Ice Bin	\$240
SSC-24	For 24" Ice Bin	268
SSC-30	For 30" Ice Bin	297
SSC-36	For 36" Ice Bin	318
SSC-42	For 42" Ice Bin	363
SSC-48	For 48" Ice Bin	374



For Older Style Ice Bins Prior to 2015

SSC-23	For 24" Ice Bin	\$311
SSC-29	For 30" Ice Bin	325
SSC-35	For 36" Ice Bin	345

### Stainless Steel Leg Upgrade

Includes 2 Sets of (2) S/S Legs w/ Adj. S/S Bullet Feet & Adj. S/S Front-to-Back Cross-Bracing

SU-10B	10" legs (16" Deep Ice Bins)	\$347
SU-10C	14" legs (12" Deep Ice Bins) Leg Heights Do Not Include 1 1/4" Bullet Foot Height	360

### Stainless Steel Ice Bin Partitions

A-38	8" High x 14 3/4" Wide Partition	174
A-39	12" High x 14 3/4" Wide Partition	174
A-40	16" High x 14 3/4" Wide Partition	174
SU-24	Provision To Connect Underbar Equipment (Price Per Every 2 Units)	199
SU-30	Soda Chase Provision (Tip-Out) (Only For Ice Bins w/Backsplash)	637

**NSF** All Drainboards Are NSF Approved



SLD-3

- Embossed & Seamless Drainboard
- 4" Backsplash
- Galvanized Legs w/ Adjustable Galvanized Side Cross-Bracing & Adjustable Plastic Bullet Feet
- 1" IPS Drain
- CRD Series Has Rear Deck For Extra Storage

### FREE-STANDING BAR DRAINBOARDS 29" Working Height

Overall Length	18" WIDE			21" WIDE				
	Model #	Price	Approx. Weight	Cu. Ft.	Model #	Price	Approx. Weight	Cu. Ft.
12"	SLD-12	\$927	26 lbs.	7	CRD-12	\$1035	28 lbs.	8
18"	SLD-18	1020	29 lbs.	7	CRD-18	1167	30 lbs.	8
24"	SLD-2	1191	35 lbs.	7	CRD-2	1267	39 lbs.	8
30"	SLD-30	1263	40 lbs.	10	CRD-30	1436	41 lbs.	12
36"	SLD-3	1384	42 lbs.	10	CRD-3	1520	47 lbs.	12
48"	SLD-4	1640	55 lbs.	12	CRD-4	1767	51 lbs.	16

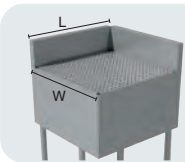

#### MAKE 24" CORNER DRAINBOARDS

Add to SLD-2 or CRD-2 Drainboards Only

Model #	Price	W x L
SU-1824R or L	\$300	18" x 24"
SU-2124R or L	334	21" x 24"

Add SU-40 To Prep Unit For Speed Rail Installation - \$116

### RECESSED BAR DRAINBOARDS

Holds Multiple Tiers Of Glasses • 23 1/2" Working Height



SL-GS-12 Shown  
23" Wide Units



CR-GS-18 shown  
26" Wide Units

- Includes Four Galvanized Legs w/ Adjustable Galvanized Side Cross-Bracing & Adjustable Plastic Bullet Feet
- Embossed And Seamless Drainboard
- 1" IPS Drain Centered In Drainboard
- CR-GS Series Has Rear Deck For Extra Storage

Overall Length	23" WIDE			26" WIDE				
	Model #	Price	Approx. Weight	Cu. Ft.	Model #	Price	Approx. Weight	Cu. Ft.
12"	SL-GS-12	\$864	20 lbs.	6	CR-GS-12	\$982	20 lbs.	6
15"	SL-GS-15	912	22 lbs.	6	CR-GS-15	1002	22 lbs.	6
18"	SL-GS-18	993	24 lbs.	7	CR-GS-18	1076	24 lbs.	8
24"	SL-GS-24	1109	28 lbs.	7	CR-GS-24	1229	28 lbs.	8

### FROZEN DRINK MACHINE STANDS

10-1/2" Working Height



SCFD-18



Creased surface to allow liquids to flow towards rear center drain

- 14" Backsplash
- Features A Lower Working Height To Accommodate The Height Of Most Drink Machines For Underbar Use
- Beveled Front
- Drain Centered In Back Of Unit
- Galvanized Legs w/ Adjustable Plastic Bullet Feet
- Adjustable Galvanized Side Cross-Bracing

**SCFD-18 \$1441**

18" x 28" x 33"  
Holds One Drink Machine  
45 lbs. 10 Cu. Ft.

# BLENDER STATIONS

## Blender Stations & Uni-Serv Speed Bar

Underbar **Basics™**

### BLENDER STATIONS

Includes Four Galvanized Legs w/ Adjustable Plastic Bullet Feet  
Featuring Adjustable Galvanized Side Cross-Bracing  
All Faucets Meet Federal Lead Free Standards



All Blender Stations Include A  
15A - 120V GFI Duplex Receptacle  
Hidden Beneath Blender Shelf

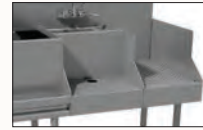

**WANT US TO CONNECT IT?**  
Add SU-24

Price Per Every Two Units **\$199**



### w/ Dump Sink & Faucet

- Dump Sink
- 4" Backsplash
- 15A - 120V GFI Duplex Outlet Hidden Beneath Shelf
- Recessed Step For Blenders
- Grommet Hole For Blender Power Cords
- 1" IPS Drain

- **SL-RS Series** Includes 4" O.C. Splash Mounted Swing Spout Faucet
- **CR-RS Series** Includes 4" O.C. Deck Mounted Swing Spout Faucet And Has Rear Deck For Extra Storage

**SL-RS Series**  
23" Wide Units With  
Splash Mount Faucet

**CR-RS Series**  
26" Wide Units With  
Deck Mount Faucet

Overall Length	23" WIDE	Price	Approx. Weight	Approx. Cu. Ft.	26" WIDE	Price	Approx. Weight	Approx. Cu. Ft.
12"	<b>SL-RS-12</b>	<b>\$1550</b>	20 lbs.	6	<b>CR-RS-12</b>	<b>\$1617</b>	21 lbs.	6
18"	<b>SL-RS-18</b>	<b>1777</b>	23 lbs.	6	<b>CR-RS-18</b>	<b>1852</b>	23 lbs.	6

### BLENDER STATION ACCESSORIES & MODIFICATIONS



A-16

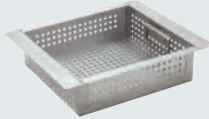

A-17

- A-15 Chrome Towel Ring (Packed Loose) ..... **\$136**
- A-16 Perforated Basket (Fits 10" x 14" x 7" & 10" x 14" x 10" Sinks) ..... **341**
- A-17 Perforated Basket (Fits 9-1/2" x 11-1/2" x 6 Sink) ..... **334**
- K-316-LU Add Wrist Handles ..... **167**
- SU-10A 18" Stainless Steel Leg Upgrade (Set of 4 -Includes Adjustable Front-to-Back Cross-Bracing) ..... **360**

6" Stainless Steel Open Waste Chute  
Fits 6" Dia. Cutout

A-6  
**\$182**



Dipper Well Faucet

A-33  
**\$224**



6" Dipper Well with Insert and Drain  
Fits 6" Dia. Cutout

A-7  
**\$476**



Water Filler Faucet

K-54  
8-1/4" High **\$744**



K-54A  
13" High **\$845**

Add **SU-34** Cutout for A6 or A-7  
**\$135**

### UNI-SERV SPEED BAR

12" Deep Ice Bin w/ Dump Sink, Recessed Drainboard & Blender Station • 29" Working Height

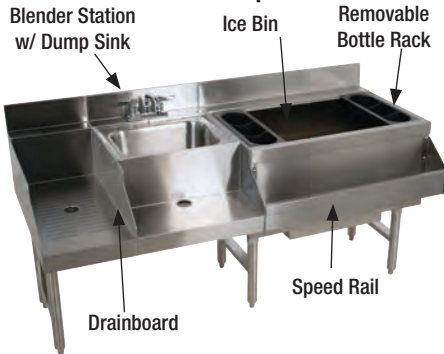

**CRU-60R Shown**

- 4" Backsplash
- 26" Front To Back
- SRK-30 - 30" Speed Rail
- 30" Insulated Ice Bin
- 98 lbs. Ice Bin Capacity
- Two Removable Plastic Bottle Racks
- Optional 7-Circuit Cold Plate Sealed Into The Bottom Of Ice Bin
- Dump Sink
- 4" O.C. Deck Mounted Swing Spout Faucet
- Recessed Drainboard for Glassware
- Dual Blender/Mixer Recess
- Galvanized Legs w/ Adjustable Plastic Bullet Feet & Adjustable Galvanized Side Cross-Bracing



15A - 120V GFI Duplex Receptacle Hidden Beneath Blender Shelf

Model #	Price	Overall Length	Approx. Weight	Approx. Cu. Ft.
<b>CRU-60L or R</b>	<b>\$4831</b>	60"	110 lbs.	23
<b>w/ 7-CIRCUIT COLD PLATE</b>				
<b>CRU-60L-7 or R-7</b>	<b>6772</b>	60"	193 lbs.	23

L And R Indicate Ice Bin Location.

### BEER BOX

18" Deep • 29" Working Height

- Perforated False Bottom Allows Melted Ice To Drain
- False Bottom Is Removable For Easy Cleaning
- 4" Backsplash
- Stainless Steel Legs w/ Adjustable Stainless Steel Bullet Feet
- 1" I.P.S. Drain



CRBB-48

#### BEER BOX COVERS

Includes Two Padded Locks & Keys



*Beer Box Covers Must Be Removed During Normal Operation*

Model #	Price	Overall Length	Ice Bin Liner Size W x L x H	Capacity of Bottled Beer	Approx. Weight	Approx. Cu. Ft.
CRBB-48	<b>\$3176</b>	48"	20 3/4" x 45 3/4" x 18"	12 cases	220 lbs.	14
CRBB-60	<b>3399</b>	60"	20 3/4" x 57 3/4" x 18"	18 cases	225 lbs.	15

Model #	Description	Price
SU-35A	For 48" Beer Box	<b>\$997</b>
SU-35B	For 60" Beer Box	<b>1253</b>

Add SU-55 For Stainless Steel Divider add **\$240 ea.**

### LIQUOR DISPLAYS NSF

Tiered Steps & Retaining Bars Securely Display Liquor Bottles



LD-1824

#### Liquor Display Rack

- Sound Deadened
- 4" Backsplash
- Galvanized Legs w/ Adjustable Plastic Bullet Feet
- Adjustable Galvanized Side Cross-Bracing
- 26" Wide Units Have Rear Deck For Extra Storage



CRLR-24

#### Liquor Display Cabinet

- Stainless Steel Cabinet
- 4" Backsplash
- Stainless Steel Legs w/ Adjustable Bullet Feet

	Model #	Price	Overall Length	Approx. Bottle Capacity	Approx. Weight	Approx. Cu. Ft.
23" WIDE	LD-1812	<b>\$1420</b>	12"	12	30 lbs.	15
	LD-1818	<b>1570</b>	18"	20	35 lbs.	20
	LD-1824	<b>1898</b>	24"	28	40 lbs.	30
26" WIDE	LD-2112	<b>1552</b>	12"	12	30 lbs.	15
	LD-2118	<b>1752</b>	18"	20	35 lbs.	20
	LD-2124	<b>1989</b>	24"	28	40 lbs.	30

	Model #	Price	Overall Length	Approx. Bottle Capacity	Approx. Weight	Approx. Cu. Ft.
21" WIDE	CRLR-12	<b>\$1697</b>	12"	15	35 lbs.	7
	CRLR-18	<b>1975</b>	18"	20	36 lbs.	10
	CRLR-24	<b>2393</b>	24"	30	42 lbs.	13
	CRLR-30	<b>2463</b>	30"	35	47 lbs.	14
	CRLR-36	<b>2620</b>	36"	45	50 lbs.	15

### REMOVABLE STAINLESS STEEL LIQUOR DISPLAY COVERS

Includes Padlock & Two Keys. Factory Installed Only.

#### Display Rack Cover

For LD Models Only



	Length	Model #	Price
18" WIDE	12"	LC-1812	<b>\$718</b>
	18"	LC-1818	<b>796</b>
	24"	LC-1824	<b>877</b>
21" WIDE	12"	LC-2112	<b>773</b>
	18"	LC-2118	<b>853</b>
	24"	LC-2124	<b>966</b>

#### Display Cabinet Cover

For CRLR Models Only



	Length	Model #	Price
21" WIDE	12"	LC-12	<b>\$869</b>
	18"	LC-18	<b>941</b>
	24"	LC-24	<b>997</b>
	30"	LC-30	<b>1115</b>
	36"	LC-36	<b>1203</b>

For Speed Rails, See Page 101.

# BAR STORAGE

## Glassware Storage

Glass Racks Not Included • Approximate Weights & Cubes Listed



Underbar Basics™

## UNDERBAR STORAGE CABINETS

With Seamless & Embossed Drainboard Top

### Drainboard Cabinets

- 21" Width (Front to Back)
- 4" Backsplash
- 1" IPS Drain In Back Right Corner Of Top
- 3" Diameter Drain Hole In Upper Right Corner Of Back Panel
- Stainless Steel Legs w/ Adjustable Bullet Feet



**OPEN BASE**  
CRD-2B Shown



**w/ MID-SHELF**  
CRD-2BM Shown



**W/ MID-SHELF & DOOR**  
CRD-2BMD Shown

Size W x L x H	OPEN BASE		2 TIER STORAGE UNIT		2 TIER STORAGE UNIT WITH HINGED DOOR		Approx. Weight	Approx. Cu. Ft.
	Model #	Price	Model #	Price	Model #	Price		
21" x 24" x 33"	CRD-2B	<b>\$2045</b>	CRD-2BM	<b>\$2503</b>	CRD-2BMD	<b>\$2732</b>	59 lbs.	14
21" x 30" x 33"	CRD-30B	<b>2143</b>	CRD-30BM	<b>2627</b>	CRD-30BMD	<b>2866</b>	99 lbs.	18
21" x 36" x 33"	CRD-3B	<b>2382</b>	CRD-3BM	<b>2874</b>	CRD-3BMD	<b>3113</b>	140 lbs.	20
21" x 48" x 33"	CRD-4B	<b>2586</b>	CRD-4BM	<b>3079</b>	CRD-4BMD	<b>3285</b>	152 lbs.	20

### 24" Glass Rack Storage Unit



CRCR-24-CT

- 21" Width (Front to Back)
- 4" Backsplash
- Holds Up To 3 Glass Racks
- Stainless Steel Glass Rack Slides
- 1" IPS Drain In Back Right Corner Of Top
- 3" Diameter Drain Hole In Upper Right Corner Of Back Panel
- Stainless Steel Legs w/ Adjustable Bullet Feet

52 lbs. 13 Cu. Ft.

**CRCR-24 \$2070**

Flat Top - Drain Not Included

**CRCR-24-CT \$2132**

Corrugated Top

### Cabinet w/ Dump Sink & Waste Chute



- 21" x 18" x 33"
- Includes 1 Hinged Door
- 9" x 9" x 4" Dump Sink
- 4" O.C. Splash Mounted Swing Spout Lead Free Compliant Faucet
- 5 1/2" Diameter Waste Chute
- Stainless Steel Legs w/ Adjustable Bullet Feet

64 lbs. 15 Cu. Ft.

**CRDW-18 \$3149**

**Shown With Optional Door Lock and Wrist Handle Faucet**

## CABINET MODIFICATIONS & ACCESSORIES



**Add A Sink \$1316**

Splash Mount Faucet Included

**SU-22A 10" x 14" x 10" Bowl**

**SU-22C 9" x 9" x 4" Bowl**



**Add A Liquid Waste Chute With Filler Faucet**

**SU-36 \$1307**

- 5 1/2" Dia. Liquid Waste Chute
- Includes K-54 Push-Back Water Filler Faucet
- (Meets Federal Lead Free Standards)*



**Add A Door Lock**

**SU-27 \$451**

- Includes 2 Keys



**Add A Dipperwell Only**

**A-7 \$476**

- 5 1/2" Diameter
- 1-1/2" NPT Drain Connection
- Factory Installed. Includes TA-34 Cutout



**WANT US TO CONNECT IT?**

**Add SU-24 \$199**

Price Per Every Two Units

### STANDARD SPEED RAILS



#### Stainless Steel Speed Rails

- Keyhole Installation

SINGLE	Price	Size W x L x H	Bottle Capacity	Wt.	Cu. Ft.	DOUBLE	Price	Size W x L x H	Bottle Capacity	Wt.	Cu. Ft.
BK-15	\$143	4 1/2" x 15" x 5 1/2"	4	4 lbs.	1	DT-15	\$267	8 1/2" x 15" x 7"	8-10	7 lbs.	1
BK-2	145	4 1/2" x 24" x 5 1/2"	4-6	5 lbs.	1	DT-2	273	8 1/2" x 24" x 7"	10-12	8 lbs.	1
BK-30	161	4 1/2" x 30" x 5 1/2"	8-9	6 lbs.	1	DT-30	292	8 1/2" x 30" x 7"	16-18	10 lbs.	1
BK-3	168	4 1/2" x 36" x 5 1/2"	9-10	6 lbs.	1	DT-3	307	8 1/2" x 36" x 7"	18-20	11 lbs.	1
BK-4	205	4 1/2" x 48" x 5 1/2"	12-13	8 lbs.	1	DT-4	371	8 1/2" x 48" x 7"	24-26	18 lbs.	1

Single Tier  
BK-2 Shown



Double Tier  
DT-30 Shown



#### Black Plastic Speed Rails

- Injection Molded Black Plastic Construction
- Packed 6 Per Carton (Must Order Qty. of 6)
- Liquor Bottle Capacity = 5 Per Speed Rail



KS-2K

Model #	Price	Size W x L x H	Wt.	Cu. Ft.
KS-2K	\$80	4 1/8" x 23" x 5 3/8"	16 lbs.	2

Add Strap Hangers  
PR-STRAP \$68  
For KS-2K Only



PR-STRAP

## HEAVY DUTY STAINLESS STEEL SPEED RAILS



Keyhole Installation

### Standard HD Speed Rails

SINGLE TIER  
SRK-2 Shown



DOUBLE TIER  
SRKD-18 Shown



SINGLE	Price	Size W x L x H	Cap.	DOUBLE	Price	Size W x L x H	Cap.	Wt. (lbs.)	Cu. Ft.
SRK-12	\$474	5 1/4" x 12" x 7 3/4"	3	SRKD-12	\$528	10 1/2" x 12" x 9 1/4"	6	8	1
SRK-15	479	5 1/4" x 15" x 7 3/4"	4	SRKD-15	534	10 1/2" x 15" x 9 1/4"	8	9	1
SRK-18	481	5 1/4" x 18" x 7 3/4"	4-5	SRKD-18	587	10 1/2" x 18" x 9 1/4"	8-10	10	1
SRK-2	510	5 1/4" x 24" x 7 3/4"	5-6	SRKD-2	682	10 1/2" x 24" x 9 1/4"	10-12	13	1
SRK-30	514	5 1/4" x 30" x 7 3/4"	7-8	SRKD-30	758	10 1/2" x 30" x 9 1/4"	14-16	16	1
SRK-3	516	5 1/4" x 36" x 7 3/4"	9-10	SRKD-3	747	10 1/2" x 36" x 9 1/4"	18-20	18	1
SRK-42	513	5 1/4" x 42" x 7 3/4"	11-12	SRKD-42	764	10 1/2" x 42" x 9 1/4"	22-24	20	2
SRK-4	522	5 1/4" x 48" x 7 3/4"	13-14	SRKD-4	805	10 1/2" x 48" x 9 1/4"	26-28	22	2
SRK-5	533	5 1/4" x 60" x 7 3/4"	15-18	SRKD-5	855	10 1/2" x 60" x 9 1/4"	30-36	26	2
SRK-6	559	5 1/4" x 72" x 7 3/4"	19-22	SRKD-6	919	10 1/2" x 72" x 9 1/4"	38-44	28	2
SRK-7	602	5 1/4" x 84" x 7 3/4"	23-26	SRKD-7	1007	10 1/2" x 84" x 9 1/4"	46-52	30	2
SRK-8	614	5 1/4" x 96" x 7 3/4"	27-28	SRKD-8	1059	10 1/2" x 96" x 9 1/4"	54-56	32	2

Make An Odd Length  
Speed Rail  
SU-41 \$96

Make Speed Rail Accommodate  
1/2 Gallon Bottles  
SU-42 \$128

### Hang-On Style

- Removable
- Hangs On First Tier Of Any SRK Series Speed Rail
- Doubles Liquor Storage



SR-2H

Model #	Price	Size W x L x H	Cap.	Wt.	Cu. Ft.
SR-12H	\$257	6 1/4" x 12" x 8 1/2"	3	4 lbs.	1
SR-15H	266	6 1/4" x 15" x 8 1/2"	4	5 lbs.	1
SR-18H	275	6 1/4" x 18" x 8 1/2"	4-5	6 lbs.	1
SR-2H	281	6 1/4" x 24" x 8 1/2"	5-6	7 lbs.	1
SR-30H	299	6 1/4" x 30" x 8 1/2"	7-8	8 lbs.	1
SR-3H	316	6 1/4" x 36" x 8 1/2"	9-10	9 lbs.	1
SR-42H	328	6 1/4" x 42" x 8 1/2"	11-12	9 lbs.	2
SR-4H	334	6 1/4" x 48" x 8 1/2"	13-14	10 lbs.	2

Hang-On Style Speed Rails Are Not To Be Used  
With Any Other Manufacturer's Speed Rails

For Liquor Racks, See Page 99.

# PRESTIGE Signature Series MODULAR BAR DIE SYSTEM

Exclusively For Advance Tabco's Prestige Bar Equipment

Sample Modular Bar Die Layout

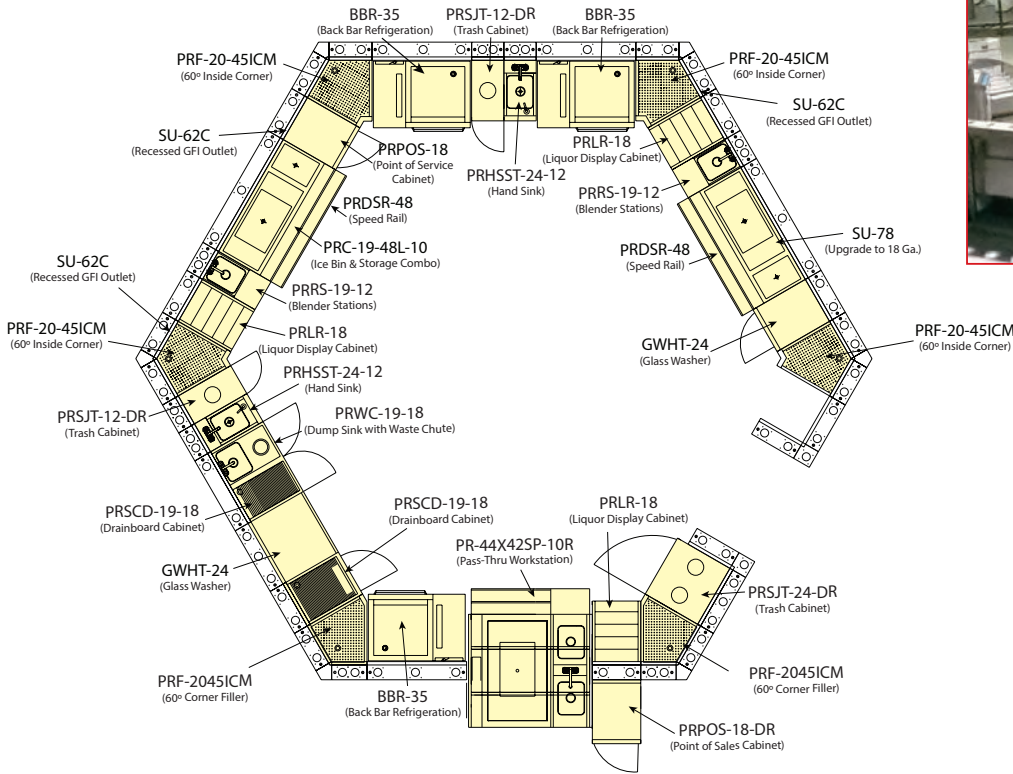

Actual Job Shown Set Up for Quality Check



**Quality & Customer Satisfaction Is Our Top Priority!**

Our factory takes the time to set up your entire Bar Die System to ensure all equipment properly fits and matches your specifications.

**Floor Templates Available SU-82**  
Call Factory For Pricing



Bar Top And Drink Rail Can Be Fabricated From Equipment Drawings Ahead Of Time.

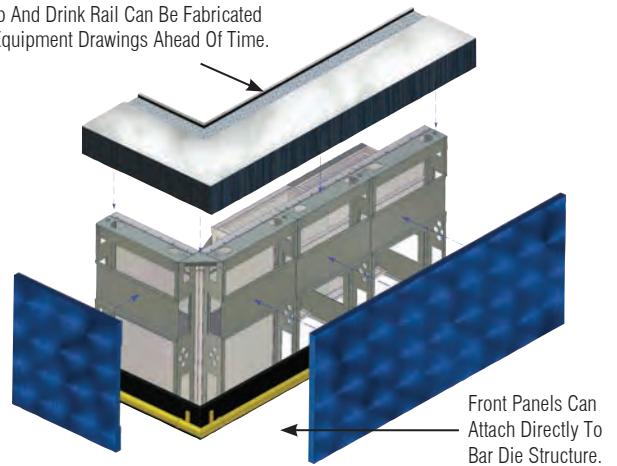

Contact Our SmartFab Department For Details at  
**800-645-3166**  
or  
SmartFab@advancetabco.com



# PRESTIGE *Signature Series* MODULAR BAR DIE SYSTEM



Exclusively For Advance Tabco's Prestige Bar Equipment

### Bartender's Side Features:

- 20 Gauge, 302 Stainless steel
- Die Wall Can Be Sealed To The Floor, Eliminating Moisture In The Bar Structure.
- Recessed Equipment Outlets Allow Bar Equipment To Be Flush Against Bar Die Wall.
- GFI Outlets Set In Place (To Be Wired By Local Electrician To Meet Local Codes)
- Stainless Steel Panels Supplied Where Equipment By Others Is Located.
- Precise Engineering To Ensure An Exact Fit.
- Enclosed Casing For Beer Towers.
- Soda Gun Outlets Supplied (Location Must Be Specified).
- Cantilever System Made For Advance Tabco's Prestige Bar Equipment, Eliminating The Need For Legs.
- Pre-Defined Space For Plumbing And Drain Lines.

**Galvanized Bar Die Wall**  
Stainless Steel Exterior On Bar Side, Galvanized Upright Structure  
**Model # PR-BARDIE**  
**\$550 per foot**

---

**Stainless Steel Bar Die Wall**  
Stainless Steel Exterior On Bar Side, Stainless Steel Upright Structure  
**Model # PR-BARDIE-SS**  
**\$655 per foot**



**Flat Panel Section**  
w/ Recessed Outlet



**Ice Bin Section**



**Cabinet Section**



**STAINLESS STEEL  
DRAINBOARD FILLERS**

Bolt On To Sides Of Equipment  
Multiple Angles Available • Optional Legs  
(See Page 109)

Contact SmartFab Department For Details & Pricing



## BAR DIE SYSTEM ACCESSORIES & MODIFICATIONS

Factory Installed Only - Except SU-BDB-100 (Supplied Loose For In Field Positioning)



**Recessed GFI  
Duplex Outlet**  
**SU-62C \$685**



**Cool White LED Light** 1.5 Watt   
• Single Box w/ Cover Plate  
• Power Supply & Wiring Not Included  
**SU-BDL-CW \$300 ea.**



**Receptacle Box  
Only**  
**SU-62F \$90**



**LED Light Power Supply**   
• 100 Watts  
• Handles Up to 35 Lights  
**SU-BDT-100 \$339 ea.**

### Floor Templates Available

**SU-82 Call For Price**



Templates Are Printed On Paper Rolls  
& Are Marked For Easy Alignment



## Underbar Hand Sinks

### All Prestige Hand Sinks Feature:

- Deep Drawn Seamless Sink Bowl
- 1 1/2" IPS, 3 1/2" Basket Drain
- 7" Backsplash
- Stainless Steel Legs w/ Stainless Steel Adjustable Bullet Feet
- Adjustable Stainless Steel Side Cross-Bracing (Except PRHSC series)

29" Working Height

All Faucets Included Meet Federal Lead Free Standards

## STANDARD BAR HAND SINKS

- **PRHS-19 Series** Includes  
4" O.C. Splash Mt. Swing Spout Faucet
- **PRHS-24 Series** Includes  
4" O.C. Deck Mt. Swing Spout Faucet  
& Has Rear Deck For Extra Storage

L	w/ SPLASH MOUNT FAUCET				w/ DECK MOUNT FAUCET			
	20" WIDE	Price	Wt.	Cu.	25" WIDE	Price	Wt.	Cu.
12"	PRHS-19-12	\$1811	35 lbs.	8	PRHS-24-12	\$1890	28 lbs.	8
18"	PRHS-19-18	1837	40 lbs.	9	PRHS-24-18	1915	30 lbs.	9



PRHS-19-12 Shown

## HAND SINKS WITH SOAP & TOWEL DISPENSER

- Deck Mount Soap Dispenser
- C-Fold Towel Dispenser
- **PRHSST-19 Series** Includes  
4" O.C. Splash Mt. Swing Spout Faucet
- **PRHSST-24 Series** Includes  
K-124 Deck Mt. Faucet & Has  
Rear Deck For Extra Storage

L	w/ SPLASH MOUNT FAUCET				w/ DECK MOUNT FAUCET			
	20" WIDE	Price	Wt.	Cu.	25" WIDE	Price	Wt.	Cu.
12"	PRHSST-19-12	\$2201	53 lbs.	8	PRHSST-24-12	\$2269	58 lbs.	8
18"	PRHSST-19-18	2224	55 lbs.	9	PRHSST-24-18	2292	60 lbs.	9



PRHSST-24-12 Shown

## HAND SINK ACCESSORIES & MODIFICATIONS



**Add Wrist Handles**  
Available For Splash or  
Deck Mount Faucets

**K-316-LU \$167**



**Chrome Towel  
Ring**  
Packed Loose

**A-15 \$136**



**Replacement  
Soap Deck Mount  
Dispenser**

**K-12 \$211**

<b>K-123</b>	Replacement Splash Mt. Faucet	<b>\$493</b>
<b>K-124</b>	Replacement Deck Mt. Faucet	<b>479</b>
<b>SU-73</b>	Add Mirror Finish <i>Factory Install Only</i>	<b>582</b>
<b>SU-74</b>	All Stainless Steel Construction Upgrade	<b>692</b>
<b>SU-75</b>	Add Welded Stainless Steel Cross-Bracing	<b>166</b>
<b>SU-20R or L</b>	Right or Left Side Splash for 20" Wide Unit	<b>255</b>
<b>SU-20RL</b>	Right & Left Side Splash for 20" Wide Unit	<b>505</b>
<b>SU-25R or L</b>	Right or Left Side Splash for 25" Wide Unit	<b>304</b>
<b>SU-25RL</b>	Right & Left Side Splash for 25" Wide Unit	<b>678</b>

For Our Full Line Of Accessories & Modifications, See Pages 118-120.



Featuring **Deep Drawn**  
Seamless Sink Bowls

**NSF** All Sinks Are NSF Approved

**PRESTIGE**  
*Signature Series*

## Underbar Multi-Use Hand Sinks

29" Working Height

All Faucets Included Meet Federal Lead Free Standards

### HAND SINK WITH DRAINBOARD

- One Piece Deep Drawn 14" X 10" X 7" Sink Bowl With 2" Drain And Strainer Plate
- K-125 Splash Mount Swing Spout Faucet
- Sturdy Stainless Steel Base Cabinet
- Removable Perforated Drainboard Top
- Stainless Steel Legs With Adjustable Stainless Steel Bullet Feet
- 7" Backsplash

L	25" WIDE	Price	Wt.	Cu. Ft.
24"	PRCS-25-24	\$3177	74 lbs.	19

Features  
Removable Perforated  
Drainboard Top

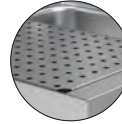

### HAND SINK WITH GLASS RINSER

- One Piece Deep Drawn 9" x 9" x 4" Sink Bowl With 2" Drain And Strainer Plate
- K-125 Splash Mount Swing Spout Faucet
- 29" Working Height
- 7" Backsplash
- Stainless Steel Top, Apron, Sides, Legs And Adjustable Bullet Feet
- Stainless Steel Glass Rinsers With Removable Drainboard
- Adjustable Stainless Steel Side Cross-Bracing

L	25" WIDE	Price	Wt.	Cu. Ft.
18"	PRCS-25-12	\$2585	65 lbs.	7

Features  
Removable Perforated  
Drainboard Top



### HAND SINK WITH GLASS RINSER & DIPPER WELL

- One Piece Deep Drawn 14" x 10" x 7" Sink Bowl With 2" Drain And Strainer Plate
- K-125 Splash Mount Swing Spout Faucet
- 29" Working Height
- 7" Backsplash
- Stainless Steel Top, Apron, Sides, Legs And Adjustable Bullet Feet
- Dipper Well With A-33 Faucet
- Stainless Steel Glass Rinsers With Removable Drainboard
- Adjustable Stainless Steel Side Cross-Bracing

L	25" WIDE	Price	Wt.	Cu. Ft.
18"	PRCS-25-18	\$3456	80 lbs.	9

Features  
Removable Perforated  
Drainboard Top

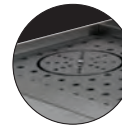

### HAND SINK WITH GLASS RINSER, DIPPER WELL & CUTTING BOARD

- One Piece Deep Drawn 9" x 9" x 4" Sink Bowl With 2" Drain And Strainer Plate
- K-125 Splash Mount Swing Spout Faucet
- 29" Working Height
- 7" Backsplash
- Stainless Steel Top, Apron, Sides, Legs And Adjustable Bullet Feet
- Dipper Well With A-33 Faucet
- Stainless Steel Glass Rinsers With Removable Drainboard
- Adjustable Stainless Steel Side Cross-Bracing
- Removable 10" x 12" Poly Cutting Board

L	25" WIDE	Price	Wt.	Cu. Ft.
24"	PRSP-25-24	\$3490	80 lbs.	11

Features  
Removable Perforated  
Drainboard Top

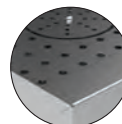

## Hand Sink Cabinets

### HAND SINKS WITH CABINET BASE

- All Stainless Steel Cabinet Base
- Hinged Cabinet Door
- **PRHSC-19 Series** Includes 4" O.C. Splash Mt. Swing Spout Faucet
- **PRHSC-24 Series** Includes K-124 Deck Mt. Faucet & Has Rear Deck For Extra Storage



PRHSC-19-12 Shown

L	w/ SPLASH MOUNT FAUCET				w/ DECK MOUNT FAUCET			
	20" WIDE	Price	Wt.	Cu.	25" WIDE	Price	Wt.	Cu.
12"	PRHSC-19-12	\$2463	78 lbs.	9	PRHSC-24-12	\$2555	83 lbs.	10
18"	PRHSC-19-18	2803	80 lbs.	9	PRHSC-24-18	2871	85 lbs.	10

### HAND SINK WITH BUILT-IN DUMP SINK & WASTE CHUTE **NSF**

- 9" x 9" x 4" Dump Sink
- 5-1/2" Diameter Waste Chute
- Optional Removable Hinged Doors (Add SU-27 For Door lock)
- 7" Backsplash
- Stainless Steel Legs w/ Adjustable Stainless Steel Bullet Feet
- **PRWC-19 Series** Includes 4" O.C. Splash Mt. Swing Spout Faucet
- **PRWC-24 Series** Includes 4" O.C. Deck Mt. Swing Spout Faucet & Has Rear Deck For Extra Storage



PRWC-19-18-DR Shown

L	Style	w/ SPLASH MT. FAUCET		w/ DECK MT. FAUCET		Approx. Wt.	Approx. Cu. Ft.
		25" WIDE	Price	30" WIDE	Price		
18"	w/ Hinged Door	PRWC-19-18-DR	3279	PRWC-24-18-DR	3341	67 lbs.	15

### HAND SINK ACCESSORIES & MODIFICATIONS



**Add Wrist Handles**  
Available For Splash or Deck Mount Faucets  
**K-316-LU \$167**



**Chrome Towel Ring**  
Packed Loose  
**A-15 \$136**



**Replacement Soap Deck Mount Dispenser**  
**K-12 \$211**

<b>K-123</b>	Replacement Splash Mt. Faucet	<b>\$493</b>
<b>K-124</b>	Replacement Deck Mt. Faucet	<b>479</b>
<b>SU-73</b>	Add Mirror Finish <i>Factory Install Only</i>	<b>582</b>
<b>SU-74</b>	All Stainless Steel Construction Upgrade	<b>692</b>
<b>SU-75</b>	Add Welded Stainless Steel Cross-Bracing	<b>166</b>
<b>SU-20R or L</b>	Right or Left Side Splash for 20" Wide Unit	<b>255</b>
<b>SU-20RL</b>	Right & Left Side Splash for 20" Wide Unit	<b>505</b>
<b>SU-25R or L</b>	Right or Left Side Splash for 25" Wide Unit	<b>304</b>
<b>SU-25RL</b>	Right & Left Side Splash for 25" Wide Unit	<b>678</b>

For Our Full Line Of Accessories & Modifications, See Pages 118-120.

**Featuring Deep Drawn Seamless Sink Bowls**



All Faucets Included Meet Federal Lead Free Standards

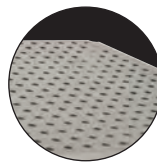

Featuring Perforated Drainboard

**PRESTIGE**  
*Signature Series*  
**Underbar Sinks**

**NSF** All Sinks Are NSF Approved

**BAR SINKS**

Featuring 10" x 14" x 10" Deep Drawn Seamless Bowls & 29" Working Height

- 7" High Backsplash
- Removable Perforated Drainboard Top
- 9" Overflow Pipe w/ 1 1/2" IPS Drain Included Per Sink Bowl
- Sound Deadened
- Stainless Steel Top, Apron, Sides
- Stainless Steel Legs w/ Adjustable Stainless Steel Bullet Feet
- Adjustable Stainless Steel Side Cross-Bracing
- **PRB-19 Series** Includes 1 - 4" O.C. Splash Mounted Swing Spout Faucet
- **PRB-24 Series** Includes 1 - 4" O.C. Deck Mounted Swing Spout Faucet & Has Rear Deck For Extra Storage



**PRB-19 Series with Drainboards Shown**  
20" Wide Units Include Splash Mount Faucet(s)



**PRB-24 Series**  
25" Wide Units With Deck Mount Faucets

L And R Indicate Sink Location. C Indicates Sink Is Centered.

	w/ SPLASH MOUNT FAUCET			w/ DECK MOUNT FAUCET			O.A. Length	# of Drbds.	Drbd. Length	Approx. Weight	Approx. Cu. Ft.
	20" WIDE	Price	Spout Length	25" WIDE	Price	Spout Length					
<b>1 COMP.</b>	PRB-19-31C	\$2448	6"	PRB-24-31C	\$2585	6"	36"	2	12"	89 lbs.	12
<b>2 COMP.</b>	PRB-19-22C	2457	6"	PRB-24-22C	2528	6"	24"	N/A	N/A	89 lbs.	8
	PRB-19-32LorR	2641	6"	PRB-24-32LorR	2750	6"	36"	1	11"	89 lbs.	12
	PRB-19-42LorR	2774	6"	PRB-24-42LorR	2923	6"	48"	1	23"	105 lbs.	16
	PRB-19-42C	2774	6"	PRB-24-42C	2923	6"	48"	2	12"	105 lbs.	16
<b>3 COMP.</b>	PRB-19-33C	2852	10"	PRB-24-33C	2946	12"	36"	N/A	N/A	105 lbs.	12
	PRB-19-43LorR	3244	10"	PRB-24-43LorR	3391	12"	48"	1	11"	107 lbs.	16
	PRB-19-53LorR	3541	10"	PRB-24-53LorR	3749	12"	60"	1	23"	125 lbs.	20
	PRB-19-53C	3630	10"	PRB-24-53C	3841	12"	60"	2	12"	125 lbs.	20
	PRB-19-63C	3818	10"	PRB-24-63C	3923	12"	72"	2	18"	143 lbs.	24
	PRB-19-73C	3969	10"	PRB-24-73C	4124	12"	84"	2	24"	190 lbs.	42
<b>4 COMP.</b>	PRB-19-83C	4725	10"	PRB-24-83C	4952	12"	96"	2	30"	176 lbs.	48
	PRB-19-44C*	3560	6"	PRB-24-44C*	3682	6"	48"	N/A	N/A	107 lbs.	16
	PRB-19-64C*	4345	6"	PRB-24-64C*	4497	6"	72"	2	12"	147 lbs.	24
	PRB-19-74C*	4508	6"	PRB-24-74C*	4688	6"	84"	2	18"	163 lbs.	42
	PRB-19-84C*	5317	6"	PRB-24-84C*	5546	6"	96"	2	24"	178 lbs.	48

\*4 Comp. Bar Sinks Include 2 - 6" Swing Spout Faucets

**BAR SINK ACCESSORIES & MODIFICATIONS**

SU-73 Add Mirror Finish (Factory Install Only)	<b>\$582</b>	SU-20R or L Right Or Left Side Splash For PRB-19 Series	<b>\$255</b>
SU-74 All Stainless Steel Construction Upgrade	<b>692</b>	SU-20RL Right & Left Side Splash For PRB-19 Series	<b>505</b>
SU-75 Add Welded Stainless Steel Cross-Bracing	<b>166</b>	SU-25R or L Right Or Left Side Splash For PRB-24 Series	<b>304</b>
SU-79 Additional Drainboard Length	<b>195 LinFt.</b>	SU-25RL Right & Left Side Splash For PRB-24 Series	<b>678</b>

# PRESTIGE

Signature Series

## Ice Bins

### PRI & PRC Series Feature:

- Includes Two Removable Plastic Bottle Racks
- 1 3/4" Return w/ Soda Gun Knock Out (Cold Plate Models Only)
- 7" Backsplash

- Stainless Steel Top, Apron & Sides
- Stainless Steel Legs w/ Adjustable Stainless Steel Bullet Feet
- Adjustable Stainless Steel Side Cross-Bracing
- 1" IPS Drain (Non-Cold Plate Bin); 1/2" IPS Drain (Cold Plate Bin)
- **OPTIONAL** 10-Circuit Cold Plate Sealed Into The Bottom

All Bottle Racks Must Be Removed For NSF Compliance & For Use With Optional Cover

Quick Pour Bottles Not Included

**NSF** All Ice Bins Are NSF Approved



Soda Chase Provision (Tip-out)  
**SU-30 \$701**  
Only For Ice Bins w/ Backsplash



PRC-19-48LR



PRI-19-24-10

## ICE BINS

### 29" Working Height

- PRI-24 Series Has Rear Deck For Extra Storage

Ice Bin Depth	Overall Length	Ice Bin Capacity	20" WIDE	Price	25" WIDE	Price	Approx. Weight	Approx. Cu. Ft.
11" DEEP	12"	32 lbs.	PRI-19-12	\$1603	PRI-24-12	\$1548	45 lbs.	11
	24"	70 lbs.	PRI-19-24	2027	PRI-24-24	1970	70 lbs.	11
	30"	89 lbs.	PRI-19-30	2174	PRI-24-30	2296	75 lbs.	15
	36"	108 lbs.	PRI-19-36	2306	PRI-24-36	2490	80 lbs.	15
	42"	127 lbs.	PRI-19-42	3154	PRI-24-42	3419	85 lbs.	20
	48"	146 lbs.	PRI-19-48	3304	PRI-24-48	3701	90 lbs.	20
15" DEEP	24"	80 lbs.	PRI-19-24-XD	3021	PRI-24-24-XD	3125	85 lbs.	20
	30"	121 lbs.	PRI-19-30-XD	2961	PRI-24-30-XD	3328	90 lbs.	27
	36"	147 lbs.	PRI-19-36-XD	2633	PRI-24-36-XD	3572	95 lbs.	37
<b>w/ 10-CIRCUIT COLD PLATE</b>								
11" DEEP	24"	70 lbs.	PRI-19-24-10	4315	PRI-24-24-10	4526	140 lbs.	18
	30"	89 lbs.	PRI-19-30-10	5167	PRI-24-30-10	5340	173 lbs.	24
	36"	108 lbs.	PRI-19-36-10	5340	PRI-24-36-10	5610	150 lbs.	24
	42"	127 lbs.	PRI-19-42-10	5408	PRI-24-42-10	5806	155 lbs.	31
	48"	146 lbs.	PRI-19-48-10	6133	PRI-24-48-10	6533	160 lbs.	31
15" DEEP	24"	80 lbs.	PRI-19-24-10-XD	5198	PRI-24-24-10-XD	5416	165 lbs.	20
	30"	121 lbs.	PRI-19-30-10-XD	5990	PRI-24-30-10-XD	6145	175 lbs.	27
	36"	147 lbs.	PRI-19-36-10-XD	6268	PRI-24-36-10-XD	7450	175 lbs.	27

## ICE BIN & BOTTLE STORAGE COMBO

### 11" Deep Insulated Ice Bin • 29" Working Height

- Welded Partition Between Bins
- PRC-24 Series Has Rear Deck For Extra Storage

L And R Indicate Ice Bin Location On Either Right Or Left Side. LR Indicates Ice Bin Is Centered.

Overall Length	# Of Independent Bins	Ice Bin Capacity	20" WIDE	Price	25" WIDE	Price	Approx. Weight	Approx. Cu. Ft.
36"	2	70/32 lbs.	PRC-19-36L or R	\$3190	PRC-24-36L or R	\$3309	105 lbs.	15
42"	2	89/32 lbs.	PRC-19-42L or R	3416	PRC-24-42L or R	3564	110 lbs.	20
48"	2	108/32 lbs.	PRC-19-48L or R	3651	PRC-24-48L or R	3826	120 lbs.	20
48"	3	32/70/32 lbs.	PRC-19-48LR	4483	PRC-24-48LR	4673	160 lbs.	22
54"	3	32/89/32 lbs.	PRC-19-54LR	4648	PRC-24-54LR	4839	165 lbs.	27
60"	3	32/108/32 lbs.	PRC-19-60LR	4835	PRC-24-60LR	5034	170 lbs.	27
<b>w/ 10-CIRCUIT COLD PLATE</b>								
36"	2	70/32 lbs.	PRC-19-36L-10 or R-10	5607	PRC-24-36L-10 or R-10	5733	165 lbs.	24
42"	2	89/32 lbs.	PRC-19-42L-10 or R-10	6015	PRC-24-42L-10 or R-10	5985	175 lbs.	31
48"	2	108/32 lbs.	PRC-19-48L-10 or R-10	6068	PRC-24-48L-10 or R-10	6240	185 lbs.	33
48"	3	32/70/32 lbs.	PRC-19-48LR-10	6907	PRC-24-48LR-10	7093	195 lbs.	33
54"	3	32/89/32 lbs.	PRC-19-54LR-10	7070	PRC-24-54LR-10	7261	200 lbs.	40
60"	3	32/108/32 lbs.	PRC-19-60LR-10	7251	PRC-24-60LR-10	7458	205 lbs.	40

\*Reverse Ice Bin Capacities For L or R Models.

For Prestige Ice Bin Covers, See Page 119.

## Underbar Corner Drainboard & Fillers

### 90° CORNER DRAINBOARD

Includes Stainless Steel Legs w/ Adjustable Stainless Steel Bullet Feet

- Free-Standing Corner Drainboard
- 7" High x 1-3/4" Thick Backsplash
- 1" I.P.S. Drain

Model #	Price	Size* (A) x (B)	Approx. Weight	Approx. Cu. Ft.
PRFD-2020	<b>\$1403</b>	20" x 20"	68 lbs.	7
PRFD-2025	<b>1482</b>	20" x 25"	72 lbs.	12
PRFD-2030	<b>1539</b>	20" x 30"	78 lbs.	16
PRFD-2035	<b>1665</b>	20" x 35"	82 lbs.	16
PRFD-2520	<b>1482</b>	25" x 20"	69 lbs.	7
PRFD-2525	<b>1554</b>	25" x 25"	73 lbs.	12
PRFD-2530	<b>1593</b>	25" x 30"	79 lbs.	16
PRFD-2535	<b>1747</b>	25" x 35"	83 lbs.	16
PRFD-3020	<b>1539</b>	30" x 20"	78 lbs.	7
PRFD-3025	<b>1593</b>	30" x 25"	79 lbs.	12
PRFD-3030	<b>1794</b>	30" x 30"	82 lbs.	16
PRFD-3035	<b>1880</b>	30" x 35"	86 lbs.	16
PRFD-3520	<b>1665</b>	35" x 20"	82 lbs.	16
PRFD-3525	<b>1747</b>	35" x 25"	83 lbs.	16
PRFD-3530	<b>1880</b>	35" x 30"	86 lbs.	16
PRFD-3535	<b>1984</b>	35" x 35"	90 lbs.	16

All Units On This Page Feature A Removable Perforated Drainboard Top

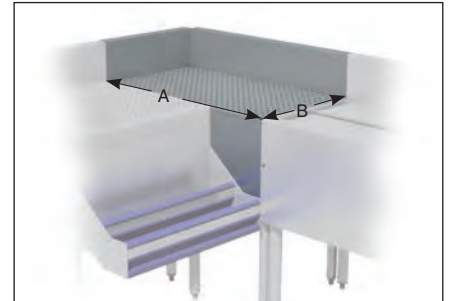
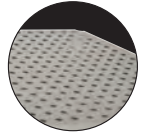

PRFD-3020

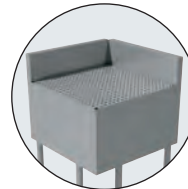

Includes Stainless Steel Legs w/ Adjustable Stainless Steel Bullet Feet

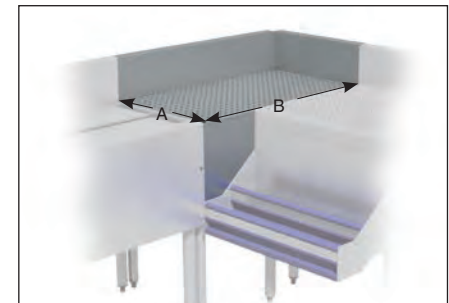

PRFD-2030

"A" represents the distance on the left side from the back wall until the front edge of the left unit.  
 "B" represents the distance on the right side from the back wall until the front edge of the right unit.

### 90° CORNER FILLERS

- Must Be Bolted to Existing Line Up Equipment
- 7" High x 1-3/4" Thick Backsplash
- Available On Left or Right Side
- 1" I.P.S. Drain

#### Inside Corner



PRF-20-90IC Shown

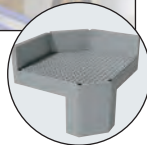

#### Outside Corner

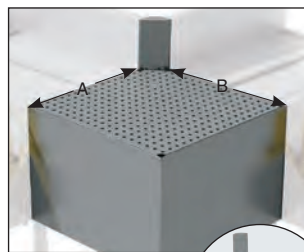

PRF-20-90OC Shown

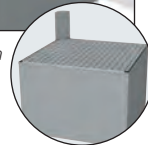

Model #	Price	Size (A) x (B)	Approx. Weight	Approx. Cu. Ft.
PRF-20-90IC or OC*	<b>\$1498</b>	20" x 20"	82 lbs.	16
PRF-25-90IC or OC*	<b>1554</b>	25" x 25"	84 lbs.	16

\* IC = Inside Corner OC = Outside Corner

### 45° CORNER FILLERS

- Must Be Bolted to Existing Line Up Equipment
- 7" High x 1-3/4" Thick Backsplash
- 1" I.P.S. Drain

#### Inside Corner

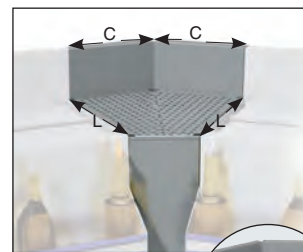

PRF-20-45IC Shown



#### Outside Corner

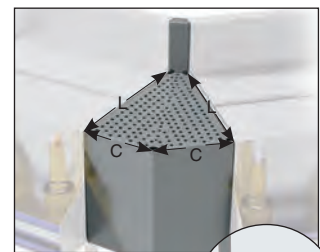

PRF-20-45OC Shown

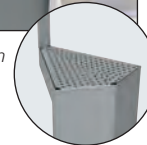

	Model #	Price	Size L x W x H	C	Approx. Weight	Approx. Cu. Ft.
<b>INSIDE CORNER</b>	PRF-20-45IC	<b>\$1148</b>	20" x 20 3/8" x 21 5/8"	11 7/8"	82 lbs.	16
	PRF-25-45IC	<b>1267</b>	25" x 27 1/8" x 21 5/8"	14"	84 lbs.	16
<b>OUTSIDE CORNER</b>	PRF-20-45OC	<b>1148</b>	20" x 16 3/8" x 21 5/8"	8 7/8"	82 lbs.	16
	PRF-25-45OC	<b>1267</b>	25" x 20 1/4" x 21 5/8"	11"	84 lbs.	16

**PLEASE NOTE: FILLERS BUILT TO ORDER & CAN NOT BE RETURNED**

**OPTIONAL LEGS & CUSTOM SIZES AVAILABLE**  
 Consult Factory For Details

# PRESTIGE Signature Series



All Drainboards Are NSF Approved

## Underbar Drainboards

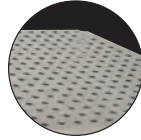

Removable Perforated Drainboard Top

### PRD & PRGS Series Feature:

- Removable Perforated Drainboard Top
- Stainless Steel Top, Sides & Legs w/ Adjustable Stainless Steel Bullet Feet
- Adjustable Stainless Steel Side Cross-Bracing
- 7" Backsplash
- 1" IPS Drain
- Sound Deadened

### 29" Working Height

- Stainless Steel Apron
- **PRD-24 Series** has Rear Deck For Extra Storage

L	20" WIDE	Price	Approx. Weight	Approx. Cu. Ft.	25" WIDE	Price	Approx. Weight	Approx. Cu. Ft.
12"	PRD-19-12	\$1300	38 lbs.	8	PRD-24-12	\$1393	45 lbs.	10
18"	PRD-19-18	1334	45 lbs.	8	PRD-24-18	1459	52 lbs.	10
24"	PRD-19-24	1444	52 lbs.	8	PRD-24-24	1584	59 lbs.	10
30"	PRD-19-30	1591	59 lbs.	12	PRD-24-30	1688	66 lbs.	14
36"	PRD-19-36	1650	65 lbs.	12	PRD-24-36	1811	73 lbs.	14
42"	PRD-19-42	1926	70 lbs.	16	PRD-24-42	2122	79 lbs.	19
48"	PRD-19-48	2070	75 lbs.	16	PRD-24-48	2159	86 lbs.	19



PRD-19 Series  
20" Wide Units



PRD-24 Series  
25" Wide Units

## RECESSED DRAINBOARDS

Holds Multiple Tiers Of Glassware • 18" Working Height

- 14" Side Splashes
- **PRGS-24 Series** has Rear Deck For Extra Storage

L	25" WIDE	Price	Approx. Weight	Approx. Cu. Ft.	30" WIDE	Price	Approx. Weight	Approx. Cu. Ft.
12"	PRGS-19-12	\$1044	40 lbs.	8	PRGS-24-12	\$1180	45 lbs.	10
18"	PRGS-19-18	1091	45 lbs.	8	PRGS-24-18	1183	52 lbs.	10
24"	PRGS-19-24	1174	52 lbs.	8	PRGS-24-24	1256	59 lbs.	10
30"	PRGS-19-30	1289	59 lbs.	12	PRGS-24-30	1412	66 lbs.	14



PRGS-19 Series  
25" Wide Units



PRGS-24 Series  
30" Wide Units

**WANT TO UPGRADE?** Add SU-74 For All Stainless Steel Construction \$516

### GLASS RINSE FOR PERFORATED DRAINBOARDS (Activator Only) **FACTORY INSTALLED ONLY**

SU-16P	\$993	4 1/4" Diameter	3 lbs.	1
--------	-------	-----------------	--------	---



SU-16P

## FROZEN DRINK MACHINE STANDS

21" Working Height



PRFD-18

- Lower Working Height Accommodates The Height Of Most Drink Machines For Underbar Use
- Beveled Front
- Top Pitched To 1" IPS Drain
- Stainless Steel Top, Apron, Sides & Legs w/ Adjustable Stainless Steel Bullet Feet
- Adjustable Stainless Steel Side Cross-Bracing
- 15" Backsplash

L	30" WIDE	Price	Wt.	Cu. Ft.
18"	PRFD-18	\$1715	57 lbs.	14
30"	PRFD-30	2422	80 lbs.	20



# PRESTIGE Signature Series Drainboard Cabinets



**Open Base**  
PRSCO-19-24 Shown



**w/ Hinged Doors**  
PRSCD-24-24 Shown



All Stainless Steel Construction

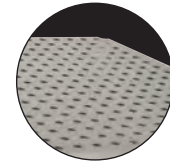

Features  
Removable Perforated  
Drainboard Top

- Sturdy Base Cabinet
- Removable Perforated Drainboard Top
- Removable Hinged Doors
- 7" Backsplash
- Stainless Steel Legs w/ Adjustable Stainless Steel Bullet Feet
- 1" IPS Drain
- Sound Deadened

	L	25" WIDE	Price	Approx. Weight	Approx. Cu. Ft.	30" WIDE	Price	Approx. Weight	Approx. Cu. Ft.
OPEN BASE	12"	PRSCO-19-12	\$1790	48 lbs.	12	PRSCO-24-12	\$1960	55 lbs.	15
	18"	PRSCO-19-18	1954	55 lbs.	12	PRSCO-24-18	2124	62 lbs.	15
	24"	PRSCO-19-24	2175	62 lbs.	12	PRSCO-24-24	2331	69 lbs.	15
	30"	PRSCO-19-30	2584	69 lbs.	15	PRSCO-24-30	2740	76 lbs.	18
	36"	PRSCO-19-36	2979	75 lbs.	18	PRSCO-24-36	3139	82 lbs.	22
	42"	PRSCO-19-42	3357	80 lbs.	21	PRSCO-24-42	3515	90 lbs.	28
	48"	PRSCO-19-48	3766	85 lbs.	24	PRSCO-24-48	3924	92 lbs.	30
W/ HINGED DOORS	12"	PRSCD-19-12	2158	58 lbs.	12	PRSCD-24-12	2333	65 lbs.	15
	18"	PRSCD-19-18	2323	65 lbs.	12	PRSCD-24-18	2497	72 lbs.	15
	24"	PRSCD-19-24	2589	72 lbs.	12	PRSCD-24-24	2749	79 lbs.	15
	30"	PRSCD-19-30	3000	79 lbs.	15	PRSCD-24-30	3158	85 lbs.	18
	36"	PRSCD-19-36	3398	85 lbs.	18	PRSCD-24-36	3555	92 lbs.	22
	42"	PRSCD-19-42	3776	90 lbs.	21	PRSCD-24-42	4098	98 lbs.	28
	48"	PRSCD-19-48	4189	95 lbs.	24	PRSCD-24-48	4341	102 lbs.	30

## PRSCO & PRSCD Series Modifications And Accessories

### ADD MID-SHELF TO PRSCO SERIES \$600/shelf

Add An "-M" After The Model Number  
(For example, PRSCO-19-18 would read PRSCO-19-18-M)

### ADD A SINK (Includes Faucet)

10" x 14" x 10" SU-22A \$1316  
9" x 9" x 4" SU-22C \$1316

6" Stainless Steel  
Open Waste Chute  
Fits 6" Dia. Cutout

A-6  
\$182



Factory Installed

6" Dipper Well with  
Insert and Drain  
Fits 6" Dia. Cutout

A-7  
\$476



Factory Installed. Includes TA-34 Cutout.

**20" WIDE CABINETS AVAILABLE!**  
Use 25" Wide Model # & Add SU-77 \$119

**LOCK IT UP!**  
Add A Door Lock SU-27 \$451

# PRESTIGE

*Signature Series*

## Trash Receptacles

### TRASH RECEPTACLE CABINET WITH CHUTE

**Trash Bin Not Included**

- Open Bottom w/ Hinged Door
- Accommodates Slim Jim® Trash Can Measuring 11" x 20" x 25" (15 7/8 Gal. Cap.)
- S/S Legs w/ Adj. Stainless Steel Bullet Feet
- Overall Size: 12" x 25" x 33-3/4"
- 60 lbs. 9 Cu. Ft.

**PRSJT-12-DR \$2219**

PRSJT-DR



Shown With Slim Jim® Trash Can (Not Included)

### TRASH RECEPTACLE COVER WITH CHUTE

**Trash Bin Not Included**

- Accommodates Slim Jim® Trash Can Measuring 11" x 20" x 25" (15 7/8 Gallon Capacity)
- Units Mount Between Equipment Line Up
- Overall Size: 12" x 25" x 9-3/4"
- 33 lbs. 4 Cu. Ft.

**PRSJT-12 \$994**



Shown With Slim Jim® Trash Can (Not Included)



### TRASH RECEPTACLE COVER WITH DOOR

**Trash Bin Not Included**

- Open Bottom w/ Hinged Door
- Accommodates Slim Jim® Trash Can Measuring 11" x 20" x 25" (15 7/8 Gallon Capacity)
- Units Mount Between Equipment Line Up
- Removable S/S Sliding Cover
- Overall Size: 12" x 25" x 21-5/8"
- 35 lbs. 4 Cu. Ft.

**PRT-12 \$1806**



Shown With Slim Jim® Trash Can (Not Included)

PRT-12

### POINT OF SERVICE CABINET



**PRPOS-18-DR**  
Shown with  
Optional  
Door Lock



- 25" Working Height
- 11" High Backsplash & Side Splashes
- Louvered Door w/ Flush Handle
- 2" Access Hole In Work Surface For Power Cord
- Stainless Steel Top, Apron, Sides & Legs  
With Adjustable Stainless Steel Bullet Feet

### Optional Legs Support

Model	Location	Price
SU-48L	Left	<b>\$408</b>
SU-48R	Right	<b>\$408</b>

(One Set Includes Two Legs with Cross-Brace)

For Models  
PRSJT-12  
& PRT-12



L	25" WIDE	Price	Wt.	Cu. Ft.
18"	PRPOS-18-DR	<b>\$2904</b>	60 lbs.	14
24"	PRPOS-24-DR	<b>\$3246</b>	150 lbs.	20

**LOCK IT UP!**  
Add A Door Lock SU-27 **\$451**

## Underbar Speed Bars & Bins

### PASS-THRU ICE BINS

11" Deep Insulated Ice Bin • 29" Working Height

- Stainless Steel Top, Apron, Sides & Legs w/ Adjustable Stainless Steel Bullet Feet
- Adjustable Stainless Steel Side Cross-Bracing
- **PRPT-2442-10** Has 10-Circuit Cold Plate Sealed Into The Bottom

For Sliding Stainless Steel Covers, See Page 119



Shown With Optional Speed Rail

Model #	Price	Size W x L x H	Ice Capacity	Wt.	Cu. Ft.
PRPT-2442	<b>\$3288</b>	42" x 24" x 29"	174 lbs.	80 lbs.	13
PRPT-2442-10	<b>5716</b>	42" x 24" x 29"	174 lbs.	150 lbs.	13



### BEER BOX

18" Deep • 29" Working Height

- Perforated False Bottom Allows Melted Ice To Drain
- Removable False Bottom
- Stainless Steel Legs w/ Stainless Steel Bullet Feet
- 7" Backsplash



PRBB-48

Model #	Price	Size W x L x H	Capacity Of Bottle Beer	Wt.	Cu. Ft.
PRBB-48	<b>\$4044</b>	25" x 48" x 33"	12 Cases	220 lbs.	14
PRBB-60	<b>4335</b>	25" x 60" x 33"	18 Cases	225 lbs.	15

#### BEER BOX LOCKING COVERS

Includes Padlock & 2 Keys			
SU-35C	48" Cover	<b>\$1076</b>	
SU-35D	60" Cover	<b>1332</b>	

Add Stainless Steel Dividers  
SU-55 **\$240 ea.**

*Beer Box Covers Must Be Removed During Normal Operation*

### UNI-SERV SPEED BAR

Includes 30" Speed Rail • 7" Backsplash



PRU-24-60R Shown



15A - 120V GFI Duplex Receptacle Hidden Beneath Blender Shelf



- **48" Units:** 9" x 9" x 4" Deep Drawn Sink Bowl
- **60" Units:** 10" x 14" x 7" Deep Drawn Sink Bowl
- Recessed 18" Blender Station
- 3 1/2" Basket Drain
- Grommet Hole For Cord
- 30" x 11" Deep Insulated Ice Bin with Two Removable Plastic Bottle Racks
- Optional 10-Circuit Cold Plate Sealed Into The Bottom Of Ice Bin
- 1" I.P.S. Drain (1/2" I.P.S. Drain For Cold Plate Models)
- 7" Backsplash with 1 3/4" Return With

- Soda Gun Knock Out
- Recessed Drainboard with Removable Perforated Top with 1" I.P.S. Drain
- Stainless Steel Top, Apron, Sides & Legs with Stainless Steel Bullet Feet
- Adjustable Stainless Steel Side Cross-Bracing
- **PRU-19 Series:** 4" O.C. Splash Mounted Swing Spout Faucet
- **PRU-24 Series:** 4" O.C. Deck Mounted Swing Spout Faucet

L	25" WIDE	O.A. Size	Price	30" WIDE	O.A. Size	Price	Approx. Weight	Approx. Cu. Ft.
48"	PRU-19-48LorR	25"x48"	<b>\$5210</b>	PRU-24-48LorR	30"x48"	<b>\$5790</b>	135 lbs.	35
60"	PRU-19-60LorR	25"x60"	<b>6111</b>	PRU-24-60LorR	30"x60"	<b>6188</b>	135 lbs.	35
w/ 10-CIRCUIT COLD PLATE								
48"	PRU-19-48L-10orR-10	25"x48"	<b>6933</b>	PRU-24-48L-10orR-10	30"x48"	<b>7601</b>	170 lbs.	46
60"	PRU-19-60L-10orR-10	25"x60"	<b>8532</b>	PRU-24-60L-10orR-10	30"x60"	<b>8611</b>	170 lbs.	46

*L and R Indicate Ice Bin Location.*

## Pass-Thru Units & Overshelves

### PASS-THRU WORKSTATION

With Two Deep Drawn Sink Bowls • 29" Working Height

- Stainless Steel Top & Sides
- Blender Shelf With Duplex Outlet Hidden Underneath
- Double Tier Speed Rail
- Tubing Chase For Soda Gun
- 15A - 120V GFI Duplex Outlet Hidden Beneath Shelf
- 4" O.C. Deck Mounted Lead Free Compliant Swing Spout Faucet
- Insulated Ice Bin w/ 10-Circuit Cold Plate Sealed Into Bottom
- Stainless Steel Legs w/ Adjustable Stainless Steel Bullet Feet & Welded Cross-Bracing
- **Side Panel Models** Include Removable Perforated Top w/ Drain & Front Apron; Units Are Supported By Side Panels & Do Not Require Legs



GFI Duplex Receptacle Hidden Beneath Blender Shelf



PR-44X42SP-10-L

Model #	Price	O.A. Length	Description	Ice Capacity	Approx. Weight	Approx. Cu. Ft.
PR-42X30-10-L or R	<b>\$7481</b>	42"	Stainless Steel Legs	70 lbs.	250 lbs.	38
PR-42X42-10-L or R	<b>12403</b>	42"	Stainless Steel Legs	174 lbs.	400 lbs.	58
<b>SIDE PANELS WITH PERFORATED DRAINBOARD SHELF</b>						
PR-44X30SP-10-L or R	<b>10563</b>	44"	Side Panels w/ Perforated Drbd. Shelf	70 lbs.	350 lbs.	59
PR-44X42SP-10-L or R	<b>17806</b>	44"	Side Panels w/ Perforated Drbd. Shelf	174 lbs.	575 lbs.	88

**Dual Soda Gun Holder**

- Openings for a single soda gun on each end
- Fits Prestige® Pass-Thru Workstations Only

**SU-43 \$1352**  
Factory Installed Only

*NOTE: To determine left or right hand model, Ice Bin is either Left (L) or Right (R) of the sink from the bartender side.*

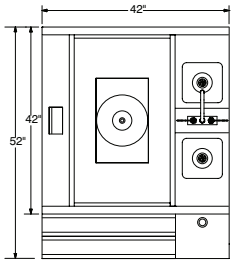

PR-42X42-10-L Shown

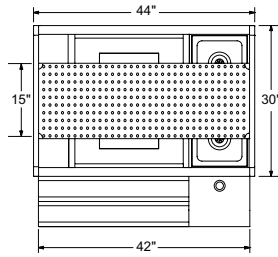

PR-44X30SP-10-L Shown

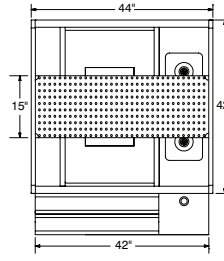

PR-44X42SP-10-L Shown

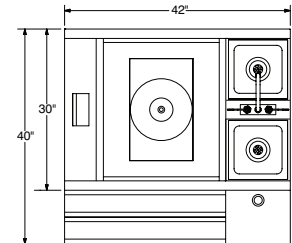

PR-42X30-10-L Shown

## OVERSHELVES FOR PASS-THRU WORKSTATIONS

(For SP Models Only - Factory Installed)

- 44" Wide x 16 3/4" Length
- Removable Perforated Pans
- Square Stainless Steel Posts
- 20 Gauge, 300 Stainless Steel

**-G Models:**

- Include Stemware Glass Rack
- 18 Gauge, 302 Stainless Steel
- Stainless Steel Shelf With Splash On Three Sides

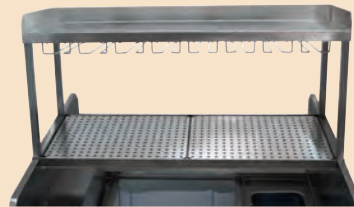

Single Shelf

PRSO-44-G Shown

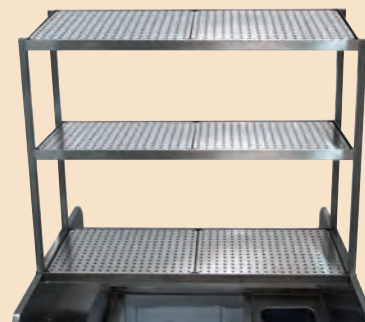

Double Shelf

PRDO-44 Shown

Model #	Price	Description	Wt.	Cu. Ft.
PRSO-44	<b>\$1672</b>	Single Overshelf	65 lbs.	5
PRSO-44-G	<b>2393</b>	Single Overshelf w/ Stemware Glass Rack	85 lbs.	5
PRDO-44	<b>2906</b>	Double Overshelf	125 lbs.	17
PRDO-44-G	<b>3955</b>	Double Overshelf w/ Stemware Glass Rack	145 lbs.	17

All Blender Stations Are 

# Free Standing Blender Stations

All Blender Stations Include:

- Stainless Steel Top, Apron
- Sides & Legs With Adjustable Stainless Steel Bullet Feet
- Adjustable Stainless Steel Side Cross-bracing



15A - 120V GFI Duplex Receptacle Hidden Beneath Blender Shelf

## BLENDER STATION WITH DEEP DRAWN SINK



**PRRS-19 Series**  
25" Wide Units With  
Splash Mount Faucet



**PRRS-24 Series**  
30" Wide Units With  
Deck Mount Faucet

- Deep Drawn Sink
- Recessed Step w/ Grommet Hole For Blenders
- 7" Backsplash
- 3 1/2" Basket Drain w/ 1 1/2" IPS
- Sound Deadened

- **PRRS-19 Series** Includes 4" O.C. Splash Mounted Swing Spout Faucet
- **PRRS-24 Series** Includes 4" O.C. Deck Mounted Swing Spout Faucet & Has Rear Deck For Extra Storage

Overall Length	w/ SPLASH MT. FAUCET				w/ DECK MT. FAUCET			
	25" WIDE	Price	Approx. Weight	Approx. Cu. Ft.	30" WIDE	Price	Approx. Weight	Approx. Cu. Ft.
12"	PRRS-19-12	<b>\$1723</b>	49 lbs.	9	PRRS-24-12	<b>\$1891</b>	51 lbs.	9
18"	PRRS-19-18	<b>1849</b>	56 lbs.	9	PRRS-24-18	<b>2013</b>	58 lbs.	12

## BLENDER STATION WITH DRAINBOARD



**PRDB-19 Series**  
25" Wide Units



**PRDB-24 Series**  
30" Wide Units

- Removable Perforated Drainboard Top
- Recessed Step w/ Grommet Hole For Blenders
- 7" Backsplash
- 1" IPS Drain

- Sound Deadened
- **PRDB-24 Series** Has Rear Deck For Extra Storage

Overall Length	25" WIDE				30" WIDE			
	Price	Approx. Weight	Approx. Cu. Ft.	Price	Approx. Weight	Approx. Cu. Ft.		
12"	PRDB-19-12	<b>\$1156</b>	45 lbs.	9	PRDB-24-12	<b>\$1282</b>	47 lbs.	9
18"	PRDB-19-18	<b>1363</b>	50 lbs.	9	PRDB-24-18	<b>1502</b>	53 lbs.	12

**NOTE: Blender Stations Can Not Accommodate A Speed Rail**

### BLENDER STATION ACCESSORIES & MODIFICATIONS

- SU-73 Add Mirror Finish *Factory Install Only* ..... **\$582**
- SU-74 All Stainless Steel Construction Upgrade ..... **692**
- SU-75 Add Welded Stainless Steel Cross-Bracing ..... **166**

6" Stainless Steel Open Waste Chute  
Fits 6" Dia. Cutout

A-6  
**\$182**



Dipper Well Faucet

A-33  
**\$224**



6" Dipper Well with Insert and Drain  
Fits 6" Dia. Cutout

A-7  
**\$476**



Water Filler Faucet

K-54  
8-1/4" High **\$744**  
K-54A  
13" High **\$845**



Add **SU-34** Cutout for A6 or A-7  
**\$135**

## Glassware & Liquor Storage

### GLASS RACK STORAGE CABINETS

Featuring All Stainless Steel Construction



Glass & Liquor Racks Not Included

- Holds Up To 3 Glass Racks
- Adjustable Glass Rack Slides
- 7" Backsplash
- 1" IPS Drain On Bottom Shelf
- Stainless Steel Legs w/ Adjustable Stainless Steel Bullet Feet
- 30" Wide Units Have Rear Deck For Extra Storage



Open Top

PROR-24-24  
Shown



Drainboard Top

Removable Perforated  
Drainboard Top  
1" IPS Drain

PRCR-19-24  
Shown



Slanted Top

- Accommodates Liquor Rack On Slanted Top

PRSR-24-24  
Shown

Model #	Price	Size	Wt.	Cu.
PROR-19-24	\$2826	24" x 25" x 36"	50 lbs.	12
PROR-24-24	2952	24" x 30" x 36"	57 lbs.	12

Model #	Price	Size	Wt.	Cu.
PRCR-19-24	\$2177	24" x 25" x 36"	80 lbs.	16
PRCR-24-24	2343	24" x 30" x 36"	85 lbs.	17

Model #	Price	Size	Wt.	Cu.
PRSR-19-24	\$3083	24" x 25" x 36"	50 lbs.	12
PRSR-24-24	3213	24" x 30" x 36"	57 lbs.	12



Add Stainless Steel  
Full Extension Roller Slides

SU-46 \$1300 /cabinet



Add Stainless Steel  
Concealing Drawer Front

Requires SU-46

SU-47 \$651 /cabinet

## LIQUOR DISPLAYS

Tiered Steps & Retaining Bars Securely Display Liquor Bottles



PLD-2524



PRLR-24

### Liquor Display Rack

- Retaining Bars Secure Bottles On Steps
- Sound Deadened
- 7" Backsplash
- Stainless Steel Top, Sides & Legs w/ Stainless Steel Bullet Feet
- Adjustable Stainless Steel Side Cross-Bracing
- 30" Wide Units Has Rear Deck For Extra Storage

	Model #	Price	Overall Length	Approx. Bottle Capacity	Approx. Weight	Approx. Cu. Ft.
25" WIDE	PLD-2512	\$1755	12"	15	25 lbs.	10
	PLD-2518	1856	18"	20	30 lbs.	10
	PLD-2524	2170	24"	30	35 lbs.	10
	PLD-2530	2312	30"	35	40 lbs.	14
	PLD-2536	2514	36"	45	50 lbs.	14
30" WIDE	PLD-3012	1969	12"	15	30 lbs.	12
	PLD-3018	2042	18"	20	35 lbs.	12
	PLD-3024	2184	24"	30	40 lbs.	12
	PLD-3030	2346	30"	35	45 lbs.	17
	PLD-3036	2553	36"	45	55 lbs.	17

### Liquor Display Cabinet

- All Stainless Steel Construction
- 7" Backsplash
- Stainless Steel Legs w/ Adjustable Stainless Steel Bullet Feet

	Model #	Price	Overall Length	Approx. Bottle Capacity	Approx. Weight	Approx. Cu. Ft.
25" WIDE	PRLR-12	\$1900	12"	15	35 lbs.	7
	PRLR-18	2004	18"	20	36 lbs.	10
	PRLR-24	2103	24"	30	42 lbs.	13
	PRLR-30	2273	30"	35	47 lbs.	14
	PRLR-36	2506	36"	45	50 lbs.	15

## REMOVABLE STAINLESS STEEL LIQUOR DISPLAY COVERS

Includes Padlock & Two Keys



Display Rack Cover

For PLD Models Only

	Length	Model #	Price
25" WIDE	12"	PRLC-2512	\$935
	18"	PRLC-2518	1015
	24"	PRLC-2524	1096
	30"	PRLC-2530	1179
	36"	PRLC-2536	1260
30" WIDE	12"	PRLC-3012	1034
	18"	PRLC-3018	1293
	24"	PRLC-3024	1357
	30"	PRLC-3030	1406
	36"	PRLC-3036	1454



Display Cabinet Cover

For PRLR Models Only

	Length	Model #	Price
25" WIDE	12"	PRLC-12	\$1130
	18"	PRLC-18	1332
	24"	PRLC-24	1448
	30"	PRLC-30	1506
	36"	PRLC-36	1592

For Prestige Speed Rails, See Pages 117.

COVERS ARE FACTORY INSTALLED ONLY

## ALL STAINLESS STEEL SPEED RAILS NSF

For Prestige Underbar Equipment

- Sound Deadened
- Bolt Holes For Mounting

**Single & Double Tier Options Available**



**Single Tier**  
PRSSR-36 Shown



**Double Tier**  
PRDSR-36 Shown

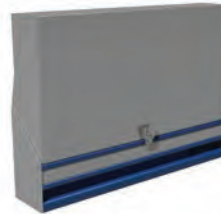

**PRSSR Series**  
w/ Locking Cover



**PRDSR Series**  
w/ Locking Cover

L	STANDARD SPEED RAILS						W/ LOCKING COVER <small>Includes Keyed Lock</small>						Approx. Wt.	Approx. Cu. Ft.
	SINGLE	Price	Cap.	DOUBLE	Price	Cap.	SINGLE	Price	Cap.	DOUBLE	Price	Cap.		
12"	PRSSR-12	\$540	3	PRDSR-12	\$674	6	PRSSR-12-LC	\$876	3	PRDSR-12-LC	\$1103	6	8 lbs.	1
18"	PRSSR-18	555	4	PRDSR-18	765	8	PRSSR-18-LC	1005	4	PRDSR-18-LC	1361	8	10 lbs.	2
24"	PRSSR-24	574	6	PRDSR-24	848	12	PRSSR-24-LC	1075	6	PRDSR-24-LC	1520	12	12 lbs.	2
30"	PRSSR-30	595	7	PRDSR-30	932	14	PRSSR-30-LC	1146	7	PRDSR-30-LC	1688	14	14 lbs.	3
36"	PRSSR-36	615	9	PRDSR-36	1007	18	PRSSR-36-LC	1216	9	PRDSR-36-LC	1837	18	14 lbs.	3
42"	PRSSR-42	630	10	PRDSR-42	1095	20	PRSSR-42-LC	1292	10	PRDSR-42-LC	2008	20	16 lbs.	4
48"	PRSSR-48	647	12	PRDSR-48	1179	24	PRSSR-48-LC	1364	12	PRDSR-48-LC	2173	24	16 lbs.	4
54"	PRSSR-54	671	13	PRDSR-54	1264	26	NOT AVAILABLE						18 lbs.	5
60"	PRSSR-60	690	15	PRDSR-60	1343	30							20 lbs.	5
72"	PRSSR-72	724	18	PRDSR-72	1511	36							24 lbs.	6
84"	PRSSR-84	764	21	PRDSR-84	1674	42							28 lbs.	7
96"	PRSSR-96	802	24	PRDSR-96	1822	48							32 lbs.	8

## Hang-On Style Speed Rails

- Designed To Hang-on The First Tier Of Any PRSSR Series Speed Rails
- Doubles Liquor Storage
- Removable

**Not To Be Used With Any Other Manufacturers Speed Rails**

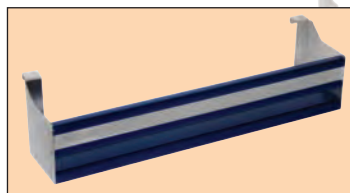

L	Model #	Price	Cap.	Approx. Wt.	Approx. Cu. Ft.
12"	PRHSR-12	\$562	3	4 lbs.	1
18"	PRHSR-18	582	4	4 lbs.	2
24"	PRHSR-24	602	6	5 lbs.	2
30"	PRHSR-30	644	7	6 lbs.	2
36"	PRHSR-36	644	9	6 lbs.	3
42"	PRHSR-42	662	10	7 lbs.	3
48"	PRHSR-48	688	12	7 lbs.	4

For Prestige Liquor Racks & Cabinets, See Page 107.

## BLENDER SHELVES

Mounts To The Front Apron Of Ice Bin

- All Stainless Steel Construction
- 10" Wide
- Grommet Hole For Blender Power Cords
- 15A - 120V Duplex Outlet Hidden Beneath Blender Shelf
- Keyhole Installation



15A - 120V Duplex Receptacle Hidden Beneath Blender Shelf



**EXCLUSIVELY**

For Prestige Underbar Equipment

PRA-BS-12	12" Shelf	\$355
PRA-BS-18	18" Shelf	380
PRA-BS-24	24" Shelf	433
PRA-BS-30	30" Shelf	449

For Free-Standing Blender Stations, See Page 115.

# UNDERBAR ACCESSORIES

## Underbar Modifications & Accessories

### More Underbar Accessories

A-1	Perforated Cover for 10" x 14" x 10" Sink Bowl	.....	<b>\$171</b>
A-8	24" Condiment Rack (5 Condiment Cups) Condiment Racks Hang On Backsplash Of Ice Bin	.....	<b>836</b>
SU-17	Interior Partition (For Underbar Basics & Prestige Drainboard Cabinets - Factory Installed Only)	.....	<b>299</b>
K-12	Replacement Deck Mounted Soap Dispenser	.....	<b>211</b>
SU-55	Removable Stainless Steel Divider For Beer Box	.....	<b>240</b>

### Underbar Modifications

A-51	6" Hole In Drainboard Surface (Waste Chute Installation)	.....	<b>208</b>
PR-STRAP	Stainless Steel Straps For Speed Rails (Set of 2 - For KS-2K Speed Rail Only)	.....	<b>68</b>
SU-4	Modify Prestige Series Backsplash to 4" Tall	.....	<b>33 Lin. Ft.</b>
SU-10A	Upgrade To S/S Legs & Bullet Feet (18" Legs - Includes Adjustable Front-to-Back Cross-Bracing)	.....	<b>360 Pair</b>
SU-10B	Upgrade To S/S Legs & Bullet Feet (10" Legs - Includes Adjustable Front-to-Back Cross-Bracing)	.....	<b>347 Pair</b>
SU-10C	Upgrade To S/S Legs & Bullet Feet (14" Legs - Includes Adjustable Front-to-Back Cross-Bracing)	.....	<b>360 Pair</b>
SU-13	Upgrade to 10-Circuit Cold Plate (Applies to units with 7-Circuit Cold Plate)	.....	<b>637</b>
SU-18RorL	Right or Left Welded Side Splash for 18" Wide Unit	.....	<b>229</b>
SU-18RL	Right & Left Welded Side Splash for 18" Wide Unit	.....	<b>463</b>
SU-21RorL	Right or Left Welded Side Splash for 21" Wide Unit	.....	<b>250</b>
SU-21RL	Right & Left Welded Side Splash for 21" Wide Unit	.....	<b>450</b>
SU-22A	Add 10"x14"x10" Sink To Drbd. Cabinet (Includes Splash Mt. Faucet)	.....	<b>1316</b>
SU-22C	Add 9" x 9" x 4" Sink To Drbd. Cabinet (Includes Splash Mt. Faucet)	.....	<b>1316</b>
SU-24	Provision To Connect Underbar Equipment (Price Per Every Two Units)	.....	<b>199</b>
SU-30	Soda Chase Provision - Tip-Out (For Ice Bins w/ Backsplash Only)	.....	<b>637</b>
SU-33	Working Height to Underbar Equipment	.....	<b>135</b>
SU-34	Top Cutout for Under Bar Equipment	.....	<b>135</b>
SU-36	Add 5-1/2" Diameter Waste Chute (Blender Stations & Drainboard Cabinets Only)	.....	<b>1089</b>
SU-40	Prep Unit For Installation Of Speed Rails	.....	<b>116</b>
SU-41	Make Speed Rail An Odd Length	.....	<b>96</b>
SU-42	Make Speed Rail Accommodate 1/2 Gallon Bottles	.....	<b>128</b>
SU-49	Add A 7-Circuit Cold Plate To D-24-WSIBL2 Or SLC/CRC Series Ice Bins	.....	<b>2584</b>
SU-61	Special Sizing To Reduce Length	.....	<b>N/C</b>
SU-61A	Special Modification	.....	<b>355</b>
SU-62C	Recess GFI Outlet For Bar Die	.....	<b>685</b>
SU-68	Omit Corrugation On Drainboard (Flat Top Work Surface)	.....	<b>207</b>
SU-79	Additional Drainboard Length (Flat Top Work Surface)	.....	<b>195 Lin. Ft.</b>

### BASICS SINGLE SODA GUN HOLDER (Holds One Gun On One Side)

Model #	Price	Size* L x W x H	Approx. Weight	Approx. Cu. Ft.
CRSH-4	<b>869</b>	21" x 4" x 36"	19 lbs.	3
CRSH-6	<b>869</b>	21" x 6" x 36"	19 lbs.	3

### PERFORATED BASKETS FOR UNDERBAR SINKS



**A-16 \$341**  
Fits 10" x 14" x 7" &  
10" x 14" x 10" Sinks

**A-17 \$334**  
Fits 9 1/2" x 11 1/2" x 6" Sink  
**A-17A \$345**  
Fits 9" x 9" x 4" Sink

**A-23 \$318**  
Fits 6" x 11" x 6" Sink

### REMOVABLE BLACK PLASTIC BOTTLE RACKS



**A-19 \$23 ea.**  
Single Bottle Rack  
5 1/4" x 5 1/4"

**A-20 \$70 ea.**  
3-Pack Bottle Rack  
(6 Per Carton. Must Order in Qtys. of 6)  
5 1/4" x 15 7/8"

**A-18 \$61 ea.**  
4-Pack Bottle Rack  
5" x 16 1/2"

### STAINLESS STEEL FALSE BOTTOM



**A-41** For 24" Ice Bin..... **\$161**  
**A-42** For 30" Ice Bin..... **174**  
**A-43** For 36" Ice Bin..... **194**  
**A-44** For 42" Ice Bin..... **208**  
**A-45** For 48" Ice Bin..... **222**

### SLIDING STAINLESS STEEL COVER For Free-Standing Underbar Basics Ice Bins



**SSC-12** For 12" Ice Bin ..... **\$240**  
**SSC-24** For 24" Ice Bin ..... **268**  
**SSC-30** For 30" Ice Bin ..... **297**  
**SSC-36** For 36" Ice Bin ..... **318**  
**SSC-42** For 42" Ice Bin ..... **363**  
**SSC-48** For 48" Ice Bin..... **374**  
**SSC-PT** For Pass-Thru Ice Bin..... **479**

Replacement Sliding S/S Covers For Drop-in Ice Bins, See Page 92

### STAINLESS STEEL ICE BIN PARTITION



14 3/4" Wide  
**A-38** 8" High ..... **\$174**  
**A-39** 12" High ..... **174**  
**A-40** 16" High ..... **174**

### BLENDER SHELF



**A-24 \$240**  
• 8" x 8" Add-On Blender Shelf  
• Duplex GFI Outlet Beneath Shelf  
• Grommet Hole For Power Cord

### WRIST HANDLES FOR FAUCETS



**K-316-LU \$167**  
Add Wrist Handles  
For Deck Or Splash Mt. Faucets  
Set Of 2



# UNDERBAR ACCESSORIES

## Prestige Underbar Modifications & Accessories

### Prestige Ice Bin Accessories



<b>PRA-BR-3</b>	3-Bottle Well Support Frame For Ice Bin <i>(For 20" Wide Units &amp; Required For Use w/ Cover - Bottle Wells Not Included - Use A-20)</i>	.....	<b>\$167</b>
<b>PRA-2405</b>	24" Condiment Rack (Five 1/9" Removable Plastic Condiment Cups. Racks Hang On Backsplash Of Ice Bin)	.....	<b>724</b>

### Prestige Bar Sink Accessories

<b>SU-20RorL</b>	Right or Left Side Splash for 20" Wide Unit	.....	<b>255</b>
<b>SU-20RL</b>	Right & Left Side Splash for 20" Wide Unit	.....	<b>505</b>
<b>SU-25RorL</b>	Right or Left Side Splash for 25" Wide Unit	.....	<b>304</b>
<b>SU-25RL</b>	Right & Left Side Splash for 25" Wide Unit	.....	<b>678</b>

### Prestige Underbar Modifications

<b>SU-4</b>	Modify Prestige Series Backsplash to 4" Tall	.....	<b>33</b>	<b>Lin. Ft.</b>
<b>SU-12A</b>	13" S/S "H" Leg Assembly <i>(Includes Adjustable Front-to-Back Cross-Bracing)</i>	.....	<b>347</b>	<b>Pair</b>
<b>SU-12B</b>	S/S "H" Leg Assembly For Extra Deep Ice Bins <i>(Includes Adjustable Front-to-Back Cross-Bracing)</i>	.....	<b>347</b>	<b>Pair</b>
<b>SU-27</b>	Cabinet Door Lock w/ Key	.....	<b>451</b>	
<b>SU-30</b>	Soda Chase Provision <i>(For Ice Bins w/ Backsplash Only)</i>	.....	<b>637</b>	
<b>SU-36</b>	Add Waste Chute (Blender Stations Only)	.....	<b>1089</b>	
<b>SU-44</b>	Add S/S Glass Rack Slides <i>(Prestige Glass Rack Storage Cabinets Only)</i>	.....	<b>780</b>	<b>2/Set</b>
<b>SU-46</b>	Add S/S Full Extension Roller Slides <i>(Prestige Glass Rack Storage Cabinets Only)</i>	.....	<b>1300</b>	
<b>SU-47</b>	Add S/S Concealing Drawer Front <i>(Prestige Glass Rack Storage Cabinets Only)</i>	.....	<b>651</b>	
<b>SU-62C</b>	Recess GFI Outlet For Bar Die <i>(Wiring by Others)</i>	.....	<b>685</b>	
<b>SU-73</b>	Add Mirror Finish <i>Factory Install Only</i>	.....	<b>582</b>	
<b>SU-74</b>	All Stainless Steel Construction Upgrade	.....	<b>692</b>	
<b>SU-75</b>	Add Welded Stainless Steel Cross-Bracing	.....	<b>166</b>	
<b>SU-77</b>	Modify Cabinet to be 25" Wide <i>(Prestige Drainboard Cabinets Only)</i>	.....	<b>119</b>	



### TUBING CHASE

<b>PRA-19-TC</b>	For 20" Unit.....	<b>\$288</b>
<b>PRA-24-TC</b>	For 25" Unit.....	<b>300</b>

### STAINLESS STEEL TRASH RECEPTACLE COVER

*Trash Bin Not Included • Factory Install Only*



### PRST-12 \$994

- Open Unit
- Accommodates Slim Jim® Trash Can Measuring 11" x 20" x 25" (15 7/8 Gallon Capacity)\*
- Units Mount Between Equipment Line Up
- Overall Size: 12" x 25" x 21"
- 33 lbs. 4 Cu. Ft.

### SLIDING STAINLESS STEEL COVERS For Ice Bins



<b>PRA-SSC-12</b>	Fits 12" Ice Bin	.....	<b>\$275</b>
<b>PRA-SSC-18</b>	Fits 18" Ice Bin	.....	<b>279</b>
<b>PRA-SSC-24</b>	Fits 24" Ice Bin	.....	<b>285</b>
<b>PRA-SSC-30</b>	Fits 30" Ice Bin	.....	<b>310</b>
<b>PRA-SSC-36</b>	Fits 36" Ice Bin	.....	<b>334</b>
<b>PRA-SSC-42</b>	Fits 42" Ice Bin	.....	<b>419</b>
<b>PRA-SSC-48</b>	Fits 48" Ice Bin	.....	<b>430</b>
<b>PRA-SSC-PT30</b>	Fits PR-44X30SP-10L or R & PR-42X30-10L or R	.....	<b>614</b>
<b>PRA-SSC-PT42</b>	Fits PRPT-2442, PRPT-2442-10, PR-44X42SP-10L or R & PR-42X42-10L or R	.....	<b>659</b>

## PRESTIGE SODA GUN HOLDER

Mounts In Prestige Underbar Line Up

- Provides Housing For WunderBar® Soda Gun (14 Button or Smaller)
- Built-In Soda Gun Holder with Drip Cup
- Cover Allows Easy Access To Make Adjustments
- Keeps Tubing Lines Hidden For A Cleaner Workspace
- Includes Backsplash



### SINGLE SODA GUN HOLDER (Holds One Gun On One Side)

Model #	Price	Size* L x W x H	Approx. Weight	Approx. Cu. Ft.
<b>PRSH-19-4</b>	<b>\$948</b>	20" x 4" x 36"	19 lbs.	3
<b>PRSH-19-6</b>	<b>948</b>	20" x 6" x 36"	19 lbs.	3
<b>PRSH-24-4</b>	<b>1080</b>	25" x 4" x 36"	20 lbs.	3
<b>PRSH-24-6</b>	<b>1080</b>	25" x 6" x 36"	20 lbs.	3



\*Height is from the finished floor to the top of the splash

NOTE: Drain Connection Is Required On Drip Cup

## PRESTIGE UNDERBAR ADD-ONS

### Stainless Steel Underbar Fillers

*Multiple Angles Available • Optional Legs*

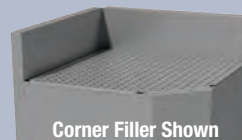

Corner Filler Shown

- Removable Perforated Drainboard Top
  - Bolt On To Sides Of Equipment
  - For Odd Shape Underbar Line Ups
- See Page 109



### Stainless Steel Base Cabinet

*Available With Or Without Doors*

- Provides Extra Storage In Bar Line Up
- Optional Door Lock

Contact Our SmartFab Department For Details & Pricing.  
SmartFab@advancetabco.com • 800-645-3166

# FAUCETS

## Underbar Equipment Faucets

All Items on This Page Ship via UPS

All Faucets Meet Federal Lead Free Standards

### UNDERBAR DECK MOUNTED SINK FAUCETS

**IMPROVED!**  
Stronger Acuator

6" Deck Mounted Faucet



K-51 **\$663**  
4" O.C.

3-1/2" Gooseneck



K-52 **\$331**  
4" O.C.

12" Swing Spout



K-53 **\$626**  
4" O.C.

Water Filler Faucet



K-54  
8-1/4" High **\$744**  
K-54A  
13" High **\$845**

Deck Mt. 6" Extended Spout 4" O.C.



K-124 **\$479**

K-208 **\$653**  
With Wrist Handles

Dipper Well Faucet



A-33 **\$224**

Gooseneck Deck Mount Melt Down Nozzle 4" O.C.



A-29 **\$732** A-30 **\$836** (Installed)

### UNDERBAR SPLASH MOUNTED SINK FAUCETS

3-1/2" Splash Mounted Faucet



K-59 **\$331**  
4" O.C.

Extra Heavy Duty Splash Mounted Faucet



K-69 **\$651**  
4" O.C.

Splash Mt. 6" Extended Spout 4" O.C.



K-123 **\$493**

Splash Mt. 6" Extended Spout with Wrist Handles



K-206 **\$624**  
4" O.C.

6" Splash Mounted Faucet



K-125 **\$432**  
4" O.C.

10" Splash Mounted Spout



K-126 **\$432**  
4" O.C.

Wrist Handles for Faucets  
(Excludes K-69)  
K-316-LU **\$167**



### UNDERBAR SINK ACCESSORIES

#### WASTE OUTLETS & CHUTES

1" Waste Outlet



A-10 (6 per carton) **\$26**

1-1/2" Waste Outlet



A-11 (6 per carton) **\$28**

6" Stainless Steel Open Waste Chute  
Fits 6" Dia. Cutout



A-6 **\$182**

6" Dipper Well with Insert and Drain  
Fits 6" Dia. Cutout



A-7 **\$476**

1-1/2" NPT Drain Connection

Add SU-34 Cutout for A6 or A-7 **\$135**

#### STAINLESS STEEL OVERFLOW PIPES



1" Pipe (6 per carton)



1-1/2" Pipe (6 per carton)

A-12 **\$26 ea.** A-13 **\$28 ea.**

(Price per each, sold in a carton of 6.  
Broken carton price \$25.00 list per each)

#### SOAP DISPENSERS & HOLDERS

Deck Mounted Soap Dispenser

K-12 **\$211**



Chrome Towel Ring  
(Packed Loose)

A-15 **\$136**



# PORTABLE BARS

## Heavy Duty Portable Bars

**ALL STAINLESS STEEL INTERIOR!** Designed For Heavy-Duty, High Volume Operation!

### HEAVY DUTY OPEN BASE

- All Stainless Steel Bartender Side
- 19" x 13-1/2" x 11" Stainless Steel Integral Insulated Ice Bin with Cover
- Full Perimeter Bumpers
- 5" Heavy Duty Swivel Plate Casters (2 w/ Brakes)

- Drain & Shut-Off Valve
- Stainless Steel Speed Rails
- Open Bottom Shelf For Glass Rack Storage



Bar Top, Front, & Sides Material	Model	Price	Length	Width	Bar Top Width	# Of Speed Rails	Speed rail Capacity	Wt.	Cu. Ft.
Black Mica	AMS-5B	<b>\$8590</b>	62 1/4"	27 1/4"	12"	2	10 Btls.	315 lbs.	70
Black Mica	AMS-6B	<b>9544</b>	74 3/8"	27 1/4"	12"	3	15 Btls.	399 lbs.	73

### HEAVY DUTY WITH DOORS

- All Stainless Steel Bartender Side
- 19" x 13-1/2" x 11" Stainless Steel Integral Insulated Ice Bin With Cover
- Full Perimeter Bumpers
- 5" Heavy Duty Swivel Plate Casters (2 w/ Brakes)
- Drain & Shut-Off Valve

- Stainless Steel Speed Rails
- Bottom Shelf For Glass Rack Storage
- Center Stainless Steel Panel For Extra Support
- Hinged Door With Lock On Left & Right Side Of Center Support Panel



Bar Top, Front, & Sides Material	Model	Price	Length	Width	Bar Top Width	# Of Speed Rails	Speed rail Capacity	Wt.	Cu. Ft.
Black Mica	AMD-5B	<b>\$9578</b>	62 1/4"	28 1/8"	12"	2	10 Btls.	423 lbs.	71
Black Mica	AMD-6B	<b>10534</b>	74 3/8"	28 1/8"	12"	3	15 Btls.	464 lbs.	73

**Upgrade with Cold Plates - Add suffix -7 after model # and add \$2014 to Bars cost. See Page 122 For All Portable Bar Modifications & Accessories.**

## Laminates & Stainless Steel Panels for Portable Series Bars

Add model number at end of Portable bar model number when ordering & add additional cost.  
(Example: AMD-6B-LCW)



### Need a Custom Color?



Custom Colors Available  
**SU-81**  
Consult Factory For Pricing & Details

See Page 122 For Even More Options

# PORTABLE BARS

## Portable Bars



**Designed For Heavy-Duty Use.  
Perfect for High Volume Operation!**

### STANDARD BLACK MICA BAR

- All Black Mica Finish
- Stainless Steel Countertop
- 19" x 13-1/2" x 11" Stainless Steel Integral Insulated Ice Bin With Cover
- Drain & Shut-Off Valve
- Open Bottom Shelf For Glass Rack Storage
- Towel Ring
- Dual Plastic Speed Rails (10 Bottle Capacity)
- 4" Swivel Plate Casters (2 w/ Brakes)

Top, Front, Back & Sides Material	Model	Price	Length	Width	Bar Top Width	Wt.	Cu. Ft.
Black Mica	D-B	<b>\$6786</b>	61"	24.50"	11"	310 lbs.	60



D-B Bartender Side Shown

### BAR WITH ALL STAINLESS STEEL WORK AREA

- Stainless Steel Countertop, Backsplash & Inside Side Panels
- 19" x 13-1/2" x 11" Stainless Steel Integral Insulated Ice Bin With Cover
- Dual Plastic Speed Rails (10 Bottle Capacity)
- Open Bottom Shelf & Mid Shelf For Glass Rack Storage
- 5" Heavy Duty Swivel Plate Casters (2 w/ Brakes)
- 2 Towel Rings

Top, Front, Back & Sides Material	Model	Price	Length	Width	Bar Top Width	Wt.	Cu. Ft.
Black Mica	R-8-B	<b>\$14432</b>	95.75"	24.50"	12"	550 lbs.	625



R-8-B Bartender Side Shown

### Portable Bar Modifications & Accessories



BK-2



DT-2



SU-80



-7

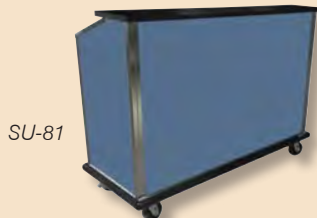

SU-81

-7 7-Circuit Cold Plate Sealed Into Bottom ..... **\$2466**  
Of Ice Bin Add The Suffix -7 To The Model Number & Add To Cost (Factory Installed Only)

BK-2 Stainless Steel Speed Rail ..... **145**

DT-2 Double Tier Stainless Steel ..... **273**  
Speed Rail

SU-80 Continuous Bumper on 3 Sides..... **1377**

SU-81 Custom Mica Colors Or S/S Panels ..... **Call Factory**

*Custom Colors Include Exterior Finishes Only  
(Bar Front And Sides. Additional Charge For Bar Top. All Interiors Are Standard Black Finish, Excluding AMS & AMD Series)*

**See Page 121 For Optional Laminates & Stainless Steel Options**

# ADVANCE TABCO HOT & COLD FOOD TABLES & DROP-INS



- Features:**
- Stainless Steel Body, Top & Sides
  - Fiberglass Insulation (Excludes Solid Top Tables)
  - 1" I.P.S. Drain (Excludes Solid Top Tables)
  - Galvanized Legs with Adjustable Bullet Feet

**Refrigerated & Hot Well Drop-Ins**



**Electric & Gas Hot Food Tables**



**Solid Top Tables**



**Everyday Buffet Tables**



**Ice-Cooled Tables**



**Refrigerated Tables**



**Sealed Wells**

These units allow water to be poured directly into the unit and get heated. Food bins may be used without the use of a Spillage Pan.



**Standard Wells**

Never pour water directly into these type of units. To use hot water in these units, must use with **Model# SP-A** Aluminum Spillage Pans or **Model # SP-S** S/S Spillage Pans.



**Refrigerated**

These units are designed to maintain chilled foods at the proper temperature.

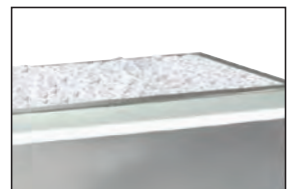

**Non-Refrigerated**

Units are designed to cool foods already chilled using only ice within its insulated bin. There is no refrigeration unit in this equipment.



# HOT WELL DROP-INS

## Electric Sealed Well Hot Food Drop-In Units

- 304 Stainless Steel Top
- Fiberglass Insulation Between Compartments
- 12" X 20" Die Stamped Pan Openings
- 6" Deep Units

- 1" I.P.S. Drain
- Remote Control Panel
- Infinite Control Knobs
- Indicator Lights

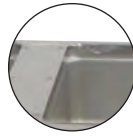

Individual Sealed Well Compartments



DISW-3-120 Shown

### STANDARD DROP-IN UNITS

Model #	Price	Length	Width	# of Wells	Cut-Out Size W x L	Volts	Amps	Watts	Approx. Wt.	Cu. Ft.
DISW-1-120	<b>\$3080</b>	15-1/2"	24-1/2"	1	23-1/2" x 15-5/8"	120	9.17	1100	73 lbs.	6
DISW-2-120	<b>4457</b>	30-1/2"	24-1/2"	2	23-1/2" x 29-5/8"	120	12.34	2200	110 lbs.	6
DISW-3-120	<b>5410</b>	44-1/2"	24-1/2"	3	23-1/2" x 43-5/8"	120	27.51	3300	135 lbs.	6
DISW-1-240	<b>3080</b>	15-1/2"	24-1/2"	1	23-1/2" x 15-5/8"	208/240	3.97/4.58	825/1100	73 lbs.	6
DISW-2-240	<b>4457</b>	30-1/2"	24-1/2"	2	23-1/2" x 29-5/8"	208/240	7.94/9.16	1650/2200	110 lbs.	6
DISW-3-240	<b>5410</b>	44-1/2"	24-1/2"	3	23-1/2" x 43-5/8"	208/240	11.91/13.74	2475/3300	135 lbs.	18
DISW-4-240	<b>6426</b>	58-1/2"	24-1/2"	4	23-1/2" x 57-5/8"	208/240	15.88/18.32	3300/4400	180 lbs.	23
DISW-5-240	<b>8368</b>	72-1/2"	24-1/2"	5	23-1/2" x 71-5/8"	208/240	19.85/22.90	4125/5500	208 lbs.	35
DISW-6-240*	<b>9867</b>	86-1/2"	24-1/2"	6	23-1/2" x 85-5/8"	208/240	23.82/27.48	4950/6600	275 lbs.	35

\*6-well unit include two sets of control panels

**NOTE:** Units are not designed to cook or heat frozen or refrigerated foods. Food placed in tables should already be hot, and the table will maintain the proper temperatures



DISLSW-2-120 Shown

### SLIMLINE DROP-IN UNITS

Model #	Price	Length	Width	# of Wells	Cut-Out Size W x L	Volts	Amps	Watts	Approx. Wt.	Cu. Ft.
DISLSW-2-120	<b>\$4928</b>	46-1/2"	16-1/2"	2	15-1/4" x 45-1/4"	120	18.34	2200	95 lbs.	11
DISLSW-3-120	<b>5914</b>	68-1/2"	16-1/2"	3	15-1/4" x 67-1/4"	120	27.51	3300	125 lbs.	11
DISLSW-2-240	<b>4928</b>	46-1/2"	16-1/2"	2	15-1/4" x 45-1/4"	208/240	3.94/9.16	1600/2200	95 lbs.	18
DISLSW-3-240	<b>5914</b>	68-1/2"	16-1/2"	3	15-1/4" x 67-1/4"	208/240	11.90/13.34	2475/3300	150 lbs.	18
DISLSW-4-240	<b>8305</b>	90-1/2"	16-1/2"	4	15-1/4" x 89-1/4"	208/240	15.88/18.32	3300/4400	155 lbs.	23

### Drop-In Unit Options & Accessories

OPTIONAL NEMA 8' CORD WITH PLUGS AVAILABLE:

Drop-In Units to be hard wired in the field. Please consult the factory for more information.



**NEMA 5-15P**  
**SU-P-234 \$223**

1 Well, 120-240v Units



**NEMA L5-30P**  
**SU-P-231 \$400**

4 Well, 120v Units

(6 well unit requires 2 Cords)



**NEMA 6-20P**  
**SU-P-232 \$144**

2 or 3 Well, 240v Units

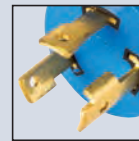

**NEMA L6-30P**  
**SU-P-233 \$367**

4, 5 or 6 Well, 240v Units

#### Autofill Upgrade

Automatically fills & maintains water level. For DISW, DISLSW, SW & HDSW Series. Requires added cost Manifold Drain Assembly (Except HDSW series). See below.

**SU-90 \$2904** Autofill Only



#### Manifold Drain Assembly

Add The Suffix **-M** To The Model Number And Add Additional Pricing Below.

**\$355** Per Well

#### Filler Faucet

- Hot Water Supply Only
- Requires **-M** Manifold Drain Assembly
- Faucet Location To Be Specified When Ordering

**K-49 \$546**



#### Thermostatic Controls

Add The Suffix **-T** To The Model Number And Add Additional Pricing Below.

**\$312** Per Well

# HOT FOOD TABLES



## Electric Hot Food Tables

- Stainless Steel Body & Top
- Galvanized Legs, Undershelf & Adjustable Bullet Feet
- Enclosed Base Units Include Stainless Steel Body & Shelf
- Fiberglass Insulation Between Each Compartment
- 8" Wide Poly Cutting Board Shelf - Ships K.D.
- Galvanized Liner. (Optional Stainless Steel Liner upgrade available **Model # SU-32 \$177 per well**)
- Infinite Control Knobs & Indicator Lights
- Single Phase Wiring (Upgrade to 3 Phase Wiring for 240 Volt Units- **Model # SU-72 \$690**)



w/ Undershelf  
HF-2E-240 Shown

### Undershelf

Model #	Price	Length	Width*	# of Wells	Volts	Amps	Watts	NEMA Plug	Wt.	Cu. Ft.
HF-2E-120	<b>\$3070</b>	31-13/16"	30-5/8"	2	120	8.33	1000	5-20P	92 lbs.	28
HF-3E-120	<b>3308</b>	47-1/8"	30-5/8"	3	120	12.50	1500	5-20P	130 lbs.	41
HF-4E-120	<b>4476</b>	62-7/16"	30-5/8"	4	120	16.67	2000	L5-30P	152 lbs.	55
HF-2E-240	<b>3070</b>	31-13/16"	30-5/8"	2	208/240	7.21/8.33	1500/2000	6-20P	92 lbs.	28
HF-3E-240	<b>3308</b>	47-1/8"	30-5/8"	3	208/240	10.82/12.50	2250/3000	6-20P	120 lbs.	41
HF-4E-240	<b>4476</b>	62-7/16"	30-5/8"	4	208/240	14.42/16.67	3000/4000	L6-30P	152 lbs.	55
HF-5E-240	<b>5917</b>	77-3/4"	30-5/8"	5	208/240	18.03/20.84	3750/5000	L6-30P	170 lbs.	67

\*Width Includes 8" Cutting Board

See Below For Stainless Steel Legs & Undershelf Upgrade

### Enclosed Base

Model #	Price	Length	Width*	# of Wells	Volts	Amps	Watts	NEMA Plug	Wt.	Cu. Ft.
HF-2E-120-BS	<b>\$5943</b>	31-13/16"	30-5/8"	2	120	8.33	1000	5-20P	92 lbs.	28
HF-3E-120-BS	<b>6551</b>	47-1/8"	30-5/8"	3	120	12.50	1500	5-20P	210 lbs.	41
HF-4E-120-BS	<b>7956</b>	62-7/16"	30-5/8"	4	120	16.67	2000	L5-30P	250 lbs.	55
HF-2E-240-BS	<b>5943</b>	31-13/16"	30-5/8"	2	208/240	7.21/8.33	1500/2000	6-20P	92 lbs.	28
HF-3E-240-BS	<b>6551</b>	47-1/8"	30-5/8"	3	208/240	10.82/12.50	2250/3000	6-20P	210 lbs.	41
HF-4E-240-BS	<b>7956</b>	62-7/16"	30-5/8"	4	208/240	14.42/16.67	3000/4000	L6-30P	250 lbs.	55
HF-5E-240-BS	<b>9489</b>	77-3/4"	30-5/8"	5	208/240	18.03/20.84	3750/5000	L6-30P	290 lbs.	67
HF-6E-240-BS	<b>10859</b>	93-1/16"	30-5/8"	5	208/240	18.03/20.84	3750/5000	L6-30P	325 lbs.	88

\*Width Includes 8" Cutting Board



Enclosed Base  
HF-5E-240-BS Shown with  
Optional TA-255P Casters

### Enclosed Base w/ Sliding Doors

Model #	Price	Length	Width*	# of Wells	Volts	Amps	Watts	NEMA Plug	Wt.	Cu. Ft.
HF-2E-120-DR	<b>\$6850</b>	31-13/16"	30-5/8"	2	120	8.33	1000	5-20P	127 lbs.	28
HF-3E-120-DR	<b>7674</b>	47-1/8"	30-5/8"	3	120	12.50	1500	5-20P	155 lbs.	41
HF-4E-120-DR	<b>9072</b>	62-7/16"	30-5/8"	4	120	16.67	2000	L5-30P	197 lbs.	55
HF-2E-240-DR	<b>6850</b>	31-13/16"	30-5/8"	2	208/240	7.21/8.33	1500/2000	6-20P	127 lbs.	28
HF-3E-240-DR	<b>7674</b>	47-1/8"	30-5/8"	3	208/240	10.82/12.50	2250/3000	6-20P	155 lbs.	41
HF-4E-240-DR	<b>9072</b>	62-7/16"	30-5/8"	4	208/240	14.42/16.67	3000/4000	L6-30P	197 lbs.	55
HF-5E-240-DR	<b>10551</b>	77-3/4"	30-5/8"	5	208/240	18.03/20.84	3750/5000	L6-30P	215 lbs.	67
HF-6E-240-DR	<b>12038</b>	93-1/16"	30-5/8"	5	208/240	18.03/20.84	3750/5000	L6-30P	250 lbs.	88

\*Width Includes 8" Cutting Board



w/ Sliding Doors  
HF-5E-240-DR Shown

NOTE: Units are not designed to cook or heat frozen or refrigerated foods. Food placed in tables should already be hot, and the table will maintain the proper temperatures

## Food Table Modifications & Accessories

For Our Full Line Of Hot Food Table Modifications, Accessories & Replacement Parts, See Page 137-140

Stainless Steel Legs & Undershelf Upgrade			
2 Wells	3 Wells	4 Wells	5 Wells
SU-23A <b>\$1080</b>	SU-23B <b>\$1117</b>	SU-23C <b>\$1185</b>	SU-23D <b>\$1332</b>

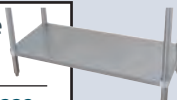

Galvanized Undershelf For Food Tables			
2 Wells	3 Wells	4 Wells	5 Wells
SU-30-UG2 <b>\$373</b>	SU-30-UG3 <b>\$474</b>	SU-30-UG4 <b>\$608</b>	SU-UG5 <b>\$686</b>



**SU-25S** Add Casters to Food Units w/Undershelf **\$646 Set of 4**  
*(Includes 4 - 5" Swivel Casters, 2 w/ Brakes & Legs that maintain height)*

**TA-255P** Add Casters to Enclosed Base Food Units **934 Set of 4**  
*(Includes 4 -5" Bolted Swivel Casters, 2 w/ Brakes)*

**SU-5G** Replacement Galvanized legs with Bullet Foot For Hot/Ice Cooled Table with Undershelf **101 ea.**  
*(HF, SW, WB, STU or CPU Series)*

**TCB-OMIT** Remove Poly Cutting Board & Shelf **-227 ea.**

**CB-OMIT** Remove Poly Cutting Board Only **-113 ea.**

**SU-19** Prepare Hot Tables To Be Locked Together **\$791 ea.**  
*(One Charge For Each Table To Be Interlocked)*

**SU-32** Upgrade to a Stainless Steel Lining **177 per well**  
*(For Electric Units. Excludes Sealed Hot Well Units)*

**SP-A** Aluminum Spillage Pan **183 ea.**

**SP-S** Stainless Steel Spillage Pan **321 ea.**

**SU-72** Upgrade 240 volt units to 3-Phase Wiring **690 ea.**

# HOT FOOD TABLES

## Electric Sealed Well Hot Food Tables



- Stainless Steel Body & Top
- Galvanized Legs, Undershef & Adjustable Bullet Feet
- Enclosed Base Units Include Stainless Steel Body & Shelf
- Stainless Steel Lining
- Fiberglass Insulation Between Each Compartment
- Drains With Gate Valves Per Well

- 8" Wide Poly Cutting Board Shelf - Ships K.D.
- 8 Ft. Electric Cord w/ Plug Included
- Infinite Control Knobs & Indicator Lights
- Single Phase Wiring (Upgrade to 3 Phase Wiring for 240 Volt Units- **Model # SU-72 \$690**)



Sealed Well with Drain Shown

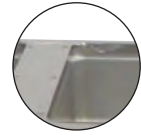

Individual Sealed Well Compartments

### Undershef

Model #	Price	Length	Width*	# of Wells	Volts	Amps	Watts	NEMA Plug	Wt.	Cu. Ft.
SW-2E-120	<b>\$3696</b>	31-13/16"	30-5/8"	2	120	10.67	1280	5-20P	92 lbs.	28
SW-3E-120	<b>4473</b>	47-1/8"	30-5/8"	3	120	16	1920	5-20P	135 lbs.	55
SW-4E-120	<b>6255</b>	62-7/16"	30-5/8"	4	120	21.33	2560	L5-30P	230 lbs.	55
SW-2E-240	<b>3696</b>	31-13/16"	30-5/8"	2	208/240	7.94/9.16	1650/2200	6-20P	92 lbs.	28
SW-3E-240	<b>4473</b>	47-1/8"	30-5/8"	3	208/240	11.91/13.74	2475/3300	6-20P	135 lbs.	41
SW-4E-240	<b>6307</b>	62-7/16"	30-5/8"	4	208/240	15.88/18.32	3300/4400	L6-30P	197 lbs.	55
SW-5E-240	<b>7772</b>	77-3/4"	30-5/8"	5	208/240	19.85/22.90	4125/5500	L6-30P	215 lbs.	67

\*Width Includes 8" Cutting Board

See Below For Stainless Steel Legs & Undershef Upgrade



w/ Undershef  
SW-3E-120 Shown

### Enclosed Base

Model #	Price	Length	Width*	# of Wells	Volts	Amps	Watts	NEMA Plug	Wt.	Cu. Ft.
SW-2E-120-BS	<b>\$6920</b>	31-13/16"	30-5/8"	2	120	10.67	1280	5-20P	127 lbs.	28
SW-3E-120-BS	<b>7949</b>	47-1/8"	30-5/8"	3	120	16	1920	5-20P	155 lbs.	41
SW-4E-120-BS	<b>9770</b>	62-7/16"	30-5/8"	4	120	21.33	2560	L5-30P	197 lbs.	54
SW-2E-240-BS	<b>6920</b>	31-13/16"	30-5/8"	2	208/240	7.94/9.16	1650/2200	6-20P	127 lbs.	28
SW-3E-240-BS	<b>7949</b>	47-1/8"	30-5/8"	3	208/240	11.91/13.74	2475/3300	6-20P	155 lbs.	41
SW-4E-240-BS	<b>9770</b>	62-7/16"	30-5/8"	4	208/240	15.88/18.32	3300/4400	L6-30P	197 lbs.	55
SW-5E-240-BS	<b>11517</b>	77-3/4"	30-5/8"	5	208/240	19.85/22.90	4125/5500	L6-30P	220 lbs.	67
SW-6E-240-BS	<b>12502</b>	93-1/16"	30-5/8"	6	208/240	23.82/27.48	4850/6600	L6-30P	255 lbs.	88

\*Width Includes 8" Cutting Board



Enclosed Base  
SW-5E-240-BS Shown  
with Optional TA-255P Casters

### Enclosed Base w/ Sliding Doors

Model #	Price	Length	Width*	# of Wells	Volts	Volts	Watts	NEMA Plug	Wt.	Cu. Ft.
SW-2E-120-DR	<b>\$7680</b>	31-13/16"	30-5/8"	2	120	10.67	1280	5-20P	145 lbs.	28
SW-3E-120-DR	<b>9395</b>	47-1/8"	30-5/8"	3	120	16	1920	5-20P	157 lbs.	41
SW-4E-120-DR	<b>11543</b>	62-7/16"	30-5/8"	4	120	21.33	2560	L5-30P	187 lbs.	54
SW-2E-240-DR	<b>7680</b>	31-13/16"	30-5/8"	2	208/240	7.94/9.16	1650/2200	6-20P	145 lbs.	28
SW-3E-240-DR	<b>9395</b>	47-1/8"	30-5/8"	3	208/240	11.91/13.74	2475/3300	6-20P	157 lbs.	41
SW-4E-240-DR	<b>11543</b>	62-7/16"	30-5/8"	4	208/240	15.88/18.32	3300/4400	L6-30P	260 lbs.	54
SW-5E-240-DR	<b>12475</b>	77-3/4"	30-5/8"	5	208/240	19.85/22.90	4125/5500	L6-30P	281 lbs.	67
SW-6E-240-DR	<b>13654</b>	93-1/16"	30-5/8"	6	208/240	23.82/27.48	4850/6600	L6-30P	316 lbs.	88

\*Width Includes 8" Cutting Board



w/ Sliding Doors  
SW-5E-240-DR Shown

NOTE: Units are not designed to cook or heat frozen or refrigerated foods. Food placed in tables should already be hot, and the table will maintain the proper temperatures

## Food Table Accessories & Modifications

For Our Full Line Of Hot Food Table Modifications, Accessories & Replacement Parts, See Page 137-140

Stainless Steel Legs & Undershef Upgrade			
2 Wells	3 Wells	4 Wells	5 Wells
SU-23A <b>\$1080</b>	SU-23B <b>\$1117</b>	SU-23C <b>\$1185</b>	SU-23D <b>\$1332</b>

Galvanized Undershef For Food Tables			
2 Wells	3 Wells	4 Wells	5 Wells
SU-30-UG2 <b>\$373</b>	SU-30-UG3 <b>\$474</b>	SU-30-UG4 <b>\$608</b>	SU-UG5 <b>\$686</b>

- T Thermostatic Control (Per Well) **\$312 ea.**
- M Manifold Drains (Per Well) **355 ea.**
- SP-A Aluminum Spillage Pan **183 ea.**
- SP-S Stainless Steel Spillage Pan **321 ea.**
- SU-25S Add Casters to Food Units w/ Undershef **646 Set of 4**  
(Includes 4 - 5" Swivel Casters, 2 w/ Brakes & Legs that maintain height)
- TA-255P Add Casters to Enclosed Base Food Units **934 Set of 4**  
(Includes 4 - 5" Bolted Swivel Casters, 2 w/ Brakes)
- SU-5G Replacement Galvanized Legs with Bullet Foot For Hot/Ice Cooled Table with Undershef **101 ea.**  
(HF, SW, WB, STU or CPU Series)

- SU-32G Upgrade to a Stainless Steel Lining **\$168 per well**  
(For Gas Units. Excludes Wetbath Units)
- SU-90 Automatically fills & maintains water level. **2904 Autofill Only**  
For DISW, DISLSW, SW & HDSW Series. Requires added cost Manifold Drain Assembly (Except HDSW series). See page 126.
- K-49 Filler Faucet for Hot Tables **546 ea.**  
(Hot water supply only. Requires -M Manifold Drain & SU-15 Prepare for Filler Faucet Provision)
- SU-15 Prepare Hot food Table For Filler Faucet **1064 ea.**  
(For Gas Units. Excludes Wetbath Units)
- TCB-OMIT Remove Poly Cutting Board & Shelf **-227 ea.**
- CB-OMIT Remove Poly Cutting Board Only **-113 ea.**





# HOT FOOD TABLES

## Gas Powered Hot Food Tables

### For Use with Optional Spillage Pans

- These Units Are Designed For Dry Operation Only.
- Stainless Steel Body & Top
- Galvanized Legs, Undershelf & Adjustable Bullet Feet
- Enclosed Base Units Include Stainless Steel Body & Shelf
- Galvanized Liner. (Optional Stainless Steel Liner upgrade available **Model # SU-32G \$168 per well**)
- 3500 BTU'S Per burner
- Fiberglass Insulation Between Each Compartment
- 8" Wide Poly Cutting Board Shelf - Ships K.D.
- Pilot Indicator Openings
- 1/2" Female NPT Connection To Regulator
- Infinite Control Knobs

Available For Natural Gas (NAT) Or Bottled Gas (LP)

### Undershelf

Model #	Price	Length	Width*	# of Wells	Approx. Weight	Approx. Cu. Ft.
HF-2G-NAT or LP	<b>\$3172</b>	31-13/16"	30-5/8"	2	92 lbs.	28
HF-3G-NAT or LP	<b>3531</b>	47-1/8"	30-5/8"	3	130 lbs.	41
HF-4G-NAT or LP	<b>4288</b>	62-7/16"	30-5/8"	4	165 lbs.	55
HF-5G-NAT or LP	<b>5279</b>	77-3/4"	30-5/8"	5	170 lbs.	67

\*Width Includes 8" Cutting Board

For Stainless Steel Legs & Undershelf Upgrade See Page 128



w/ Undershelf  
HF-3G-NAT Shown

### Enclosed Base

Model #	Price	Length	Width*	# of Wells	Approx. Weight	Approx. Cu. Ft.
HF-2G-NAT or LP-BS	<b>\$5503</b>	31-13/16"	30-5/8"	2	117 lbs.	28
HF-3G-NAT or LP-BS	<b>5779</b>	47-1/8"	30-5/8"	3	145 lbs.	41
HF-4G-NAT or LP-BS	<b>7792</b>	62-7/16"	30-5/8"	4	205 lbs.	55
HF-5G-NAT or LP-BS	<b>8922</b>	77-3/4"	30-5/8"	5	250 lbs.	67

\*Width Includes 8" Cutting Board



Enclosed Base  
HF-5G-LP-BS Shown  
with Optional TA-255P Casters

SU-19 Prepare Hot Tables to be Locked Together **\$791 ea.**

(One Charge For Each Table To Be Interlocked)

NOTE: External pressure regulator is required. 4" WC pressure in for Natural Gas and 10" WC pressure in for LP.

NOTE: Units are not designed to cook or heat frozen or refrigerated foods. Food placed in tables should already be hot, and the table will maintain the proper temperatures

**Sleek Shields™**  
Protected By: Patent No. US 9,010,883 B2

**GLASS FOOD SHIELDS**  
Mounts To Top Of Hot/Cold Food Table

#### Self-Serve Style

- 18" Standard Height (Top of Table To Top)
- 1" Stainless Steel Tubing Posts (1 5/8" Posts Also Available)
- Includes Two 18" W x 16 3/8" H Glass Side Panels
- 1/4" Thick Heat-Tempered Glass Front & Sides
- Shipped KD



Includes TA-47  
Mounting Brackets  
For In-Field Installation



Chamber Lock™  
Allows Front Glass To Lock  
In Place At 15° Intervals



NSG-15-4WELL Shown

15" Wide Stainless Steel Shelf			15" Wide w/ Glass Top			Fits # of Bowls	Approx. Wt.	Approx. Cubes
Model #	Price	O.A. Size L x W x H	Model #	Price	O.A. Size L x W x H			
NSG-15-2WELL	<b>\$4826</b>	33 11/16" x 19 3/4" x 18 3/4"	GSG-15-2WELL	<b>\$5790</b>	33 11/16" x 19 3/4" x 18"	Fits 2-Well Unit	109 lbs.	15
NSG-15-3WELL	<b>5024</b>	49" x 19 3/4" x 18 3/4"	GSG-15-3WELL	<b>6008</b>	49" x 19 3/4" x 18"	Fits 3-Well Unit	143 lbs.	22
NSG-15-4WELL*	<b>5881</b>	64 5/16" x 19 3/4" x 18 3/4"	GSG-15-4WELL*	<b>6392</b>	64 5/16" x 19 3/4" x 18"	Fits 4-Well Unit	186 lbs.	29
NSG-15-5WELL**	<b>6423</b>	79 5/8" x 19 3/4" x 18 3/4"	Not Available		Not Available	Fits 5-Well Unit	215 lbs.	38
NSG-15-6WELL**	<b>7114</b>	94 15/16" x 19 3/4" x 18 3/4"	Not Available		Not Available	Fits 6-Well Unit	247 lbs.	47

GSG Series Food Shields are slightly longer than the table they rest on. They will extend about 7/8" on either end

\*3/8" Thick Heat-Tempered Glass Required For Front Glass \*\*Requires a Single Center Post (Factory Print Included)

For Full Line Of Glass Top Food Shields  
& Food Table Accessories, See Page 137-140.

# HOT FOOD TABLES



## Gas Powered Wetbath Tables

- Stainless Steel Body & Top
- Galvanized Legs, Undershelf & Adjustable Bullet Feet
- Enclosed Base Units Include Stainless Steel Body & Shelf
- Stainless Steel Liner
- Stainless Steel Dish Shelf
- 8" Wide Poly Cutting Board Shelf - Ships K.D.
- 1/2" Female NPT Connection To Regulator
- Pilot Indicator Openings
- Infinite Control Knobs
- **2 & 3 Comp:** 15,000 BTU's
- **4 & 5 Comp:** 25,000 BTU's

### Filler Faucet K-49 \$546



- Hot Water Supply Only
- Requires **-M** Manifold Drain Assembly & **SU-15** Filler Faucet Provision
- Faucet Location To Be Specified When Ordering

Available For Natural Gas (NAT) Or Bottled Gas (LP)

### Undershelf

Model #	Price	Length	Width*	# of Wells	Approx. Weight	Approx. Cu. Ft.
WB-2G-NAT or LP	<b>\$3964</b>	31-13/16"	30-5/8"	2	96 lbs.	28
WB-3G-NAT or LP	<b>4335</b>	47-1/8"	30-5/8"	3	130 lbs.	41
WB-4G-NAT or LP	<b>5008</b>	62-7/16"	30-5/8"	4	157 lbs.	55
WB-5G-NAT or LP	<b>5891</b>	77-3/4"	30-5/8"	5	176 lbs.	67

See Below For Stainless Steel Legs & Undershelf Upgrade



w/ Undershelf  
WB-4G-LP Shown

### Enclosed Base

Model #	Price	Length	Width*	# of Wells	Approx. Weight	Approx. Cu. Ft.
WB-2G-NAT or LP-BS	<b>\$6326</b>	31-13/16"	30-5/8"	2	145 lbs.	28
WB-3G-NAT or LP-BS	<b>6795</b>	47-1/8"	30-5/8"	3	175 lbs.	41
WB-4G-NAT or LP-BS	<b>7593</b>	62-7/16"	30-5/8"	4	225 lbs.	55
WB-5G-NAT or LP-BS	<b>8493</b>	77-3/4"	30-5/8"	5	296 lbs.	67

\*Width Includes 8" Cutting Board



Enclosed Base  
WB-4G-NAT-BS Shown

NOTE: External pressure regulator is required. 4" WC pressure in for Natural Gas and 10" WC pressure in for LP.

NOTE: Units are not designed to cook or heat frozen or refrigerated foods. Food placed in tables should already be hot, and the table will maintain the proper temperatures

## Food Table Modifications & Accessories

For Our Full Line Of Hot Food Table Modifications, Accessories & Replacement Parts, See Page 137-140

### Galvanized Undershelf For Food Tables

2 Wells	3 Wells	4 Wells	5 Wells
SU-30-UG2 \$373	SU-30-UG3 \$474	SU-30-UG4 \$608	SU-UG5 \$686

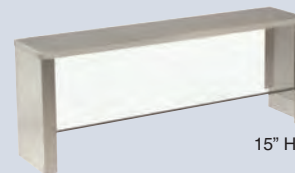
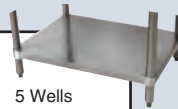

15" Height

### 10" Wide Serving Shelf with Built-In Food Shield

Model	Price	Length	Approx. Wt.	Cu. Ft.
TSS-2	<b>\$1503</b>	31-13/16"	15 lbs.	2
TSS-3	<b>1711</b>	47-1/8"	17 lbs.	3
TSS-4	<b>1866</b>	62-7/16"	19 lbs.	4
TSS-5	<b>2003</b>	77-3/4"	21 lbs.	4
TSS-6	<b>2393</b>	93-1/16"	33 lbs.	5

**SU-15** Prepare Hot Food Table for Filler Faucet (Faucet Not Included. Stationary Models Only) **\$1064 ea.**

**SU-19** Prepare Hot Tables To Be Locked Together **791 ea.**  
(One Charge For Each Table To Be Interlocked)

**SU-25S** Add Casters to Food Units w/Undershelf (Includes 4 - 5" Swivel Casters, 2 w/ Brakes & Legs that maintain height) **646 Set of 4**

**TA-255P** Add Casters to Enclosed Base Food Units **934 Set of 4**  
(Includes 4 - 5" Bolted Swivel Casters, 2 w/ Brakes)

**SU-5G** Replacement Galvanized Legs with Bullet Foot For Hot/Ice Cooled Table with Undershelf **101 ea.**  
(HF, SW, WB, STU or CPU Series)

**SP-A** Aluminum Spillage Pan **183 ea.**

**SP-S** Stainless Steel Spillage Pan **321 ea.**

**TCB-OMIT** Remove Poly Cutting Board & Shelf **-227 ea.**

**CB-OMIT** Remove Poly Cutting Board Only **-113 ea.**



### Acrylic Side Panel for Serving Shelf

Add side panels to meet additional NSF requirements (1 panel per side)

**TSP-1 \$380 One End**  
**TSP-2 \$779 Two Ends**

Field Installation Available

# SOLID FOOD TABLES

## Solid Top Tables

- Stainless Steel Body & Top
- Galvanized Legs, Undershelf & Adjustable Bullet Feet
- Enclosed Base Units Include Stainless Steel Body & Shelf
- 8" Wide Poly Cutting Board Shelf - Ships K.D.



w/Undershelf  
STU-3 Shown

### Undershelf

Model #	Price	Length	Width*	Wt.	Cu. Ft.
STU-2	<b>\$1983</b>	31-13/16"	30-5/8"	90 lbs.	12
STU-3	<b>2308</b>	47-1/8"	30-5/8"	118 lbs.	17
STU-4	<b>2735</b>	62-7/16"	30-5/8"	150 lbs.	23
STU-5	<b>3447</b>	77-3/4"	30-5/8"	168 lbs.	41

\*Width Includes 8" Cutting Board

For Stainless Steel Legs & Undershelf Upgrade See Page 128



Enclosed Base  
STU-3-BS Shown

### Enclosed Base

Model #	Price	Length	Width*	Wt.	Cu. Ft.
STU-2-BS	<b>\$6427</b>	31-13/16"	30-5/8"	115 lbs.	26
STU-3-BS	<b>6783</b>	47-1/8"	30-5/8"	143 lbs.	36
STU-4-BS	<b>8040</b>	62-7/16"	30-5/8"	185 lbs.	46
STU-5-BS	<b>8966</b>	77-3/4"	30-5/8"	203 lbs.	56

\*Width Includes 8" Cutting Board

### w/ Doors

Model #	Price	Length	Width*	Wt.	Cu. Ft.
STU-2-DR	<b>\$6962</b>	31-13/16"	30-5/8"	125 lbs.	26
STU-3-DR	<b>9403</b>	47-1/8"	30-5/8"	153 lbs.	36
STU-4-DR	<b>8769</b>	62-7/16"	30-5/8"	195 lbs.	46
STU-5-DR	<b>10249</b>	77-3/4"	30-5/8"	213 lbs.	56

\*Width Includes 8" Cutting Board



w/ Doors  
STU-5-DR Shown

SU-19 Prepare Hot Tables to be Locked Together **\$791 ea.**

(One Charge For Each Table To Be Interlocked)

TCB-OMIT Remove Poly Cutting Board & Shelf **-227 ea.**

CB-OMIT Remove Poly Cutting Board Only **-113 ea.**

## Food Table Overshelves

For Our Full Line Of Hot Food Table Modifications, Accessories & Replacement Parts, See Page 137-140



Single Overshelves



Double Overshelves

12" WIDE			18" WIDE			12" WIDE			18" WIDE						
Model	Price	Approx Wt.	Model	Price	Length	Approx Wt.	Cu. Ft.	Model	Price	Approx Wt.	Model	Price	Length	Approx Wt.	Cu. Ft.
STOS-2	<b>\$1208</b>	18 lbs.	STOS-2-18	<b>\$1536</b>	31-13/16"	20 lbs.	3	TOS-2	<b>\$2191</b>	32 lbs.	TOS-2-18	<b>\$2606</b>	31-13/16"	35 lbs.	3
STOS-3	<b>1372</b>	21 lbs.	STOS-3-18	<b>1653</b>	47-1/8"	23 lbs.	4	TOS-3	<b>2558</b>	38 lbs.	TOS-3-18	<b>3007</b>	47-1/8"	41 lbs.	4
STOS-4	<b>1544</b>	24 lbs.	STOS-4-18	<b>1790</b>	62-7/16"	26 lbs.	5	TOS-4	<b>2924</b>	44 lbs.	TOS-4-18	<b>3435</b>	62-7/16"	47 lbs.	5
STOS-5	<b>1672</b>	27 lbs.	STOS-5-18	<b>1954</b>	77-3/4"	30 lbs.	6	TOS-5	<b>3287</b>	49 lbs.	TOS-5-18	<b>3853</b>	77-3/4"	53 lbs.	6
STOS-6	<b>2039</b>	33 lbs.	STOS-6-18	<b>2383</b>	93-1/8"	35 lbs.	6	TOS-6	<b>4012</b>	56 lbs.	TOS-6-18	<b>4703</b>	93-1/8"	61 lbs.	6

# COLD WELL DROP-INS

## Drop-In Cold Pan Units

### ICE-COOLED DROP-IN COLD PAN UNITS



- 304 Stainless Steel Top
- 9" Deep Ice Bin With Fiberglass Insulation
- Black Molding with Thermal Breaker
- 1" I.P.S. Drain

	Model #	Price	Length	Width	Cut-Out Size	Ice Capacity	Approx. Wt.	Cu. Ft.
SLIMLINE	DISLCP-2	\$3420	49 5/8"	18-5/8"	17 3/8" x 48-3/8"	93	168 lbs.	11
	DISLCP-3	4129	71 1/4"	18-5/8"	17 3/8" x 70"	141	178 lbs.	18
	DISLCP-4	4715	92 7/8"	18-5/8"	17 3/8" x 91 5/8"	186	215 lbs.	23
STANDARD	DICP-1	2374	18-13/16"	26 3/4"	25 1/2" x 18 5/8"	45	129 lbs.	6
	DICP-2	2815	34-1/8"	26 3/4"	25 1/2" x 32 1/8"	93	162 lbs.	10
	DICP-3	3226	49-7/16"	26 3/4"	25 1/2" x 45 5/8"	141	165 lbs.	14
	DICP-4	4014	64-3/4"	26 3/4"	25 1/2" x 59 1/8"	188	199 lbs.	18
	DICP-5	4633	80-1/8"	26 3/4"	25 1/2" x 72 5/8"	236	240 lbs.	23
	DICP-6	5102	95-3/8"	26 3/4"	25 1/2" x 86 1/8"	284	268 lbs.	27



**Slimline**  
DISLCP-3 Shown



**Standard**  
DICP-2 Shown

### Optional Adapter Rails & Bars

DICP SERIES			DISLCP SERIES			Description
Model #	Fits Model:	Price	Model #	Fits Model:	Price	
SU-P-501	DICP-1	\$191				Two Left To Right Rails & Two Front-To-Back Supports. Includes Mounting Screws.
SU-P-502	DICP-2	\$286	SU-P-512	DISLCP-2	\$286	Two Left To Right Rails & Three Front-To-Back Supports. Includes Mounting Screws.
SU-P-503	DICP-3	\$382	SU-P-513	DISLCP-3	\$382	Two Left To Right Rails & Four Front-To-Back Supports. Includes Mounting Screws.
SU-P-504	DICP-4	\$476	SU-P-514	DISLCP-4	\$586	Two Left To Right Rails & Five Front-To-Back Supports. Includes Mounting Screws.
SU-P-505	DICP-5	\$572				Two Left To Right Rails & Six Front-To-Back Supports. Includes Mounting Screws.
SU-P-506	DICP-6	\$668				Two Left To Right Rails & Seven Front-To-Back Supports. Includes Mounting Screws.

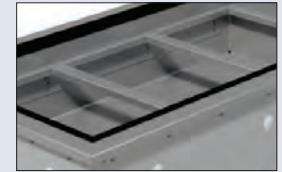

Left To Right Rails & Front To Back Supports Shown Above

**Horizontal Adapter Bars**  
For Small Pan Sizes

12" x 1"  
Model # SU-45A

Works With Required Rail Kits  
(See Grid Above)



### REFRIGERATED DROP-IN COLD PAN UNITS

- 304 Stainless Steel Top
- 9" Deep Ice Bin With Fiberglass Insulation
- Full Insulation Galvanized Outer Jacket
- Black Molding with Thermal Breaker
- High Cooling Capacity
- Sight Glass To Ensure Properly Charges System
- Low Running Current
- 1" I.P.S. Drain
- Precision Thermostat For Exact Temperature Control
- Includes Adapter Bars For 12" X 20" Food Pans (Pans not Included)
- 8 Ft. Cord & Plug Included



**Slimline**  
DISLRCP-2 Shown



**Standard**  
DIRCP-3 Shown

	Model #	Price	Length	Width	Cut-Out Size	# of Wells	Refrigerant	Approx. Wt.	Cu. Ft.
SLIMLINE	DISLRCP-2	\$9120	49-5/8"	18-5/8"	17-1/8" x 48-3/8"	2	R404-A	205 lbs.	25
	DISLRCP-3	10244	71-1/4"	18-5/8"	15-3/8" x 70"	3	R404-A	257 lbs.	31
	DISLRCP-4	11384	92-7/8"	18-5/8"	17-3/8" x 91-5/8"	4	R404-A	325 lbs.	46
STANDARD	DIRCP-1	6917	20"	26-3/4"	25-1/2" x 18-5/8"	1	R404-A	163 lbs.	14
	DIRCP-2	7392	33-1/2"	26-3/4"	25-1/2" x 32-1/8"	2	R404-A	205 lbs.	22
	DIRCP-3	8117	47"	26-3/4"	25-1/2" x 45-5/8"	3	R404-A	257 lbs.	31
	DIRCP-4	9041	60-1/2"	26-3/4"	25-1/2" x 59-1/8"	4	R404-A	325 lbs.	39
	DIRCP-5	10593	74"	26-3/4"	25-1/2" x 72-5/8"	5	R404-A	365 lbs.	47
	DIRCP-6	11356	87-1/2"	26-3/4"	25-1/2" x 86-1/8"	6	R404-A	398 lbs.	55

**SU-71** 5 Year Extended Parts Warranty on Refrigeration Unit **\$710 Per Unit**  
(Available for Refrigerated Tables & Drop-Ins. See Back Inside Cover For Full Details)



**SU-P-234** - 8' Cord with NEMA 5-15P plug Included

**NOTE: Units are not designed to cool foods originally warm. Food should already be chilled to maintain the proper temperatures**



# COLD FOOD TABLES

## Standard Ice-Cooled Tables

- 304 Stainless Steel Body & Top
- Galvanized Legs, Undershelf & Adjustable Bullet Feet
- Enclosed Base Units Include Stainless Steel Body & Shelf
- Fiberglass Insulation
- 1" I.P.S. Drain
- 8" Wide Poly Cutting Board Shelf - Ships K.D.

### Undershelf

Model #	Price	Length	Width*	Wt.	Cu. Ft.
CPU-2	<b>\$2244</b>	31-13/16"	30-5/8"	90 lbs.	12
CPU-3	<b>2904</b>	47-1/8"	30-5/8"	118 lbs.	18
CPU-4	<b>3518</b>	62-7/16"	30-5/8"	150 lbs.	23
CPU-5	<b>4135</b>	77-3/4"	30-5/8"	168 lbs.	29

\*Width Includes 8" Cutting Board

### Stainless Steel Legs & Undershelf Upgrade

2 Wells	3 Wells	4 Wells	5 Wells
SU-23A \$1080	SU-23B \$1117	SU-23C \$1185	SU-23D \$1332

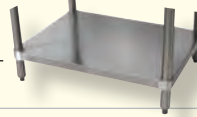

**SU-5G** Replacement Galvanized Legs with Bullet Foot For Hot/Ice Cooled Table with Undershelf (HF, SW, WB, STU or CPU Series) **\$101 ea.**



w/ Undershelf  
CPU-3 Shown

### Optional Adapter Bars

12" x 1"	20" x 3"
Model # SU-45A	Model # SU-45B
<b>\$80 ea.</b>	<b>\$90 ea.</b>

### Enclosed Base

Model #	Price	Length	Width*	Wt.	Cu. Ft.
CPU-2-BS	<b>\$5575</b>	31-13/16"	30-5/8"	115 lbs.	18
CPU-3-BS	<b>6610</b>	47-1/8"	30-5/8"	143 lbs.	34
CPU-4-BS	<b>7820</b>	62-7/16"	30-5/8"	227 lbs.	44
CPU-5-BS	<b>8259</b>	77-3/4"	30-5/8"	203 lbs.	54

\*Width Includes 8" Cutting Board

### w/ Doors

Model #	Price	Length	Width*	Wt.	Cu. Ft.
CPU-2-DR	<b>\$5874</b>	31-13/16"	30-5/8"	125 lbs.	24
CPU-3-DR	<b>7042</b>	47-1/8"	30-5/8"	153 lbs.	34
CPU-4-DR	<b>8440</b>	62-7/16"	30-5/8"	195 lbs.	44
CPU-5-DR	<b>8983</b>	77-3/4"	30-5/8"	213 lbs.	54

\*Width Includes 8" Cutting Board

Enclosed Base  
CPU-5-BS Shown  
with Optional  
Caster Kit



W/ Doors  
CPU-5-DR  
Shown

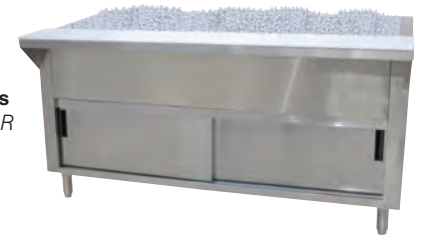

**NOTE: Units are not designed to cool foods originally warm. Food should already be chilled to maintain the proper temperatures**



### CONNECT IT!

Prepare Tables To Be Locked Together While Keeping Them Lined Up! (One Charge For Each Table To Be Interlocked)  
**SU-19 \$791 per table**

## Sleek Shields™

Protected By: Patent No. US 9,010,883 B2

### Self-Serve Style

- 18" Standard Height (Top of Table to Top)
- 1" Stainless Steel Tubing Posts (1 5/8" Posts Also Available)
- Includes Two 18" W x 16 3/8" H Glass Side Panels
- 1/4" Thick Heat-Tempered Glass Front & Sides
- Shipped KD

## GLASS FOOD SHIELDS

Mounts To Top Of Hot/Cold Food Table



Includes TA-47  
Mounting Brackets  
For In-Field Installation



Chamber Lock™  
Allows Front Glass To Lock  
In Place At 15° Intervals



NSG-15-4WELL Shown

15" Wide Stainless Steel Shelf			15" Wide w/ Glass Top			Fits # of Bowls	Approx. Wt.	Approx. Cubes
Model #	Price	O.A. Size L x W x H	Model #	Price	O.A. Size L x W x H			
NSG-15-2WELL	<b>\$4826</b>	33 11/16" x 19 3/4" x 18 3/4"	GSG-15-2WELL	<b>\$5790</b>	33 11/16" x 19 3/4" x 18"	Fits 2-Well Unit	109 lbs.	15
NSG-15-3WELL	<b>5024</b>	49" x 19 3/4" x 18 3/4"	GSG-15-3WELL	<b>6008</b>	49" x 19 3/4" x 18"	Fits 3-Well Unit	143 lbs.	22
NSG-15-4WELL*	<b>5881</b>	64 5/16" x 19 3/4" x 18 3/4"	GSG-15-4WELL*	<b>6392</b>	64 5/16" x 19 3/4" x 18"	Fits 4-Well Unit	186 lbs.	29
NSG-15-5WELL**	<b>6423</b>	79 5/8" x 19 3/4" x 18 3/4"	Not Available	Not Available	Not Available	Fits 5-Well Unit	215 lbs.	38
NSG-15-6WELL**	<b>7114</b>	94 15/16" x 19 3/4" x 18 3/4"	Not Available	Not Available	Not Available	Fits 6-Well Unit	247 lbs.	47

GSG Series Food Shields are slightly longer than the table they rest on. They will extend about 7/8" on either end

\*3/8" Thick Heat-Tempered Glass Required For Front Glass

\*\*Requires a Single Center Post (Factory Print Included)

For Full Line Of Glass Top Food Shields & Food Table Accessories, See Page 137-140.

# COLD FOOD TABLES

## Mechanically Assisted Cold Pan Tables



### REFRIGERATED COLD PAN TABLES

- 304 Stainless Steel Body, Top and Legs
- Adjustable Bullet Feet
- Heavy Duty Cabinet Base
- 8" Wide Poly Cutting Board Shelf - Ships K.D.
- 1" I.P.S. Drain
- Precision Thermostat For Exact Temperature Control
- High Cooling Capacity
- Sight Glass To Ensure Properly Charges System
- Low Running Current
- 8 Ft. Electric Cord w/ Plug Included
- Includes Adapter Bars For Optional spillage Pans



**Enclosed Base**  
MACP-3-BS Shown

#### Enclosed Base

Model #	Price	Length	Width*	Refrigerant	Wt.	Cu. Ft.
MACP-2-BS	<b>\$13745</b>	31-3/16"	30-5/8"	R404-A	230 lbs.	39
MACP-3-BS	<b>15517</b>	47-1/8"	30-5/8"	R404-A	256 lbs.	56
MACP-4-BS	<b>16770</b>	62-7/16"	30-5/8"	R404-A	380 lbs.	73
MACP-5-BS	<b>18297</b>	77-3/4"	30-5/8"	R404-A	465 lbs.	90

\*Width Includes 8" Cutting Board



**SU-P-234 - 8' Cord with NEMA 5-15P plug Included**



**Sliding Doors**  
MACP-3-DR Shown

#### w/ Sliding Doors

Model #	Price	Length	Width*	Refrigerant	Wt.	Cu. Ft.
MACP-3-DR	<b>\$16105</b>	47-1/8"	30-5/8"	R404-A	385 lbs.	41
MACP-4-DR	<b>18648</b>	62-7/16"	30-5/8"	R404-A	420 lbs.	73
MACP-5-DR	<b>20418</b>	77-3/4"	30-5/8"	R404-A	505 lbs.	90

\*Width Includes 8" Cutting Board

**SU-71 5 Year Extended Parts Warranty on Refrigeration Unit \$682 Per Unit**  
(Available for Refrigerated Tables & Drop-Ins. See Back Inside Cover For Full Details)

#### Cold Pan Table Covers

- Stainless Steel
- Plastic Handles
- Piano Hinge(s)
- Fits CPU, DICP
- MACP & BMACP Units

Model #	Price	Length	Wt.	Cu. Ft.
HC-2	<b>\$553</b>	28-9/16"	12 lbs.	3
HC-3	<b>827</b>	43-7/8"	16 lbs.	4
HC-4	<b>905</b>	59-3/16"	20 lbs.	5
HC-5	<b>1051</b>	74-1/2"	24 lbs.	6

**NOTE: Units are not designed to cool foods originally warm. Food should already be chilled to maintain the proper temperatures**

**WARNING:** Refrigerated Equipment on this page may expose you to chemicals, including Ethanes, that are known to the State of California to cause cancer or birth defects or other reproductive harm. For more Info., visit [www.p65warnings.ca.gov](http://www.p65warnings.ca.gov).

## Food Table Shelving

For Our Full Line Of Hot Food Table Modifications, Accessories & Replacement Parts, See Page 139-142



15" Height

#### Single Overshelves

12" WIDE			18" WIDE			Approx Wt.	Cu. Ft.
Model	Price	Approx Wt.	Model	Price	Length	Approx Wt.	Cu. Ft.
STOS-2	<b>\$1208</b>	18 lbs.	STOS-2-18	<b>\$1536</b>	31-13/16"	20 lbs.	3
STOS-3	<b>1372</b>	21 lbs.	STOS-3-18	<b>1653</b>	47-1/8"	23 lbs.	4
STOS-4	<b>1544</b>	24 lbs.	STOS-4-18	<b>1790</b>	62-7/16"	26 lbs.	5
STOS-5	<b>1672</b>	27 lbs.	STOS-5-18	<b>1954</b>	77-3/4"	30 lbs.	6
STOS-6	<b>2039</b>	33 lbs.	STOS-6-18	<b>2383</b>	93-1/16"	35 lbs.	6

12" Height

15" Height



#### Double Overshelves

12" WIDE			18" WIDE			Approx Wt.	Cu. Ft.
Model	Price	Approx Wt.	Model	Price	Length	Approx Wt.	Cu. Ft.
TOS-2	<b>\$2191</b>	32 lbs.	TOS-2-18	<b>\$2606</b>	31-13/16"	35 lbs.	3
TOS-3	<b>2558</b>	38 lbs.	TOS-3-18	<b>3007</b>	47-1/8"	41 lbs.	4
TOS-4	<b>2924</b>	44 lbs.	TOS-4-18	<b>3435</b>	62-7/16"	47 lbs.	5
TOS-5	<b>3287</b>	49 lbs.	TOS-5-18	<b>3853</b>	77-3/4"	53 lbs.	6
TOS-6	<b>4012</b>	56 lbs.	TOS-6-18	<b>4703</b>	93-1/16"	61 lbs.	6

## Food Table Accessories

- SU-25S** Add Casters to Food Units w/Undershelf **\$646 Set of 4**  
(Includes 4 - 5" Swivel Casters, 2 w/ Brakes & Legs that maintain height)
- SU-25** Add Casters to Food Units w/Undershelf **594 Set of 4**  
(For Units Built Before October 2015. Includes 4 - 5" Swivel Casters, 2 w/ Brakes.)
- TA-25** Replacement Casters For Undershelf Units **594 Set of 4**  
(For Units Built After October 2015. Includes 4 - 5" Swivel Casters, 2 w/ Brakes.)
- TA-255P** Add Casters to Enclosed Base Food Units (In- **934 Set of 4**  
cludes 4 - 5" Bolted Swivel Casters, 2 w/ Brakes)

- SU-19** Prepare Hot Tables to be Locked Together **\$791 ea.**  
(One Charge For Each Table To Be Interlocked)
- SU-45A** 12" x 1" Adapter Bar **80 ea.**
- SU-45B** 20" x 3" Adapter Bar **90 ea.**
- TCB-OMIT** Remove Poly Cutting Board & Shelf **-227 ea.**
- CB-OMIT** Remove Poly Cutting Board Only **-113 ea.**

**Sleek Shields™ Are Also Available For Hot & Cold Food Tables. See Pages 140 For Details.**

# HEAVY DUTY TABLES

## Heavy Duty Tables

### HEAVY DUTY ELECTRIC SEALED WELL TABLES

- Heavy Duty Construction 300 Stainless Steel Body, Top and Legs
- Adjustable Stainless Steel Bullet Feet
- 8" Wide Poly Cutting Board Shelf - Ships K.D.
- Sealed Wells w/ Manifold Drains
- Thermostatic Controls
- 8 Ft. Electric Cord w/ Plug Included
- Control Knobs & Indicator Lights
- Removable Front Panel To Access Elements (Upgrade to 3 Phase Wiring for 240 Volt Units- Model # SU-72 \$627)



**Enclosed Base**  
HDSW-3-240-BS Shown  
with Optional TA-255P Casters



#### Enclosed Base

Model #	Price	Length	Width*	# of Wells	Volts	Amps	Watts	Wt.	Cu. Ft.
HDSW-2-120-BS	\$13032	31-13/16"	35-3/4"	2	120	10.67	1280	225	31
HDSW-3-120-BS	15704	47-1/8"	35-3/4"	3	120	16	1920	340	45
HDSW-4-120-BS	18065	62-7/16"	35-3/4"	4	120	21.33	2560	430	60
HDSW-2-240-BS	13032	31-13/16"	35-3/4"	2	208/240	7.94/9.16	1650/2200	225	31
HDSW-3-240-BS	15704	47-1/8"	35-3/4"	3	208/240	11.91/13.74	2475/3300	340	45
HDSW-4-240-BS	18065	62-7/16"	35-3/4"	4	208/240	15.88/18.32	3300/4400	430	60
HDSW-5-240-BS	23575	77-3/4"	35-3/4"	5	208/240	19.85/22.90	4125/5500	520	74
HDSW-6-240-BS	27515	93-1/16"	35-3/4"	6	208/240	23.82/27.48	4850/6600	610	88

\*Width Includes 8" Cutting Board

**NOTE: Units are not designed to cook or heat frozen or refrigerated foods. Food placed in tables should already be hot, and the table will maintain the proper temperatures**

#### Autofill Upgrade

Automatically fills & maintains water level. For DISW, DISLSW, SW & HDSW Series. Requires added cost Manifold Drain Assembly (Except HDSW series). See page 126.

**SU-90 \$2904 Upgrade**

#### Filler Faucet

- Hot Water Supply Only 6" Spout
  - Faucet Location To Be Specified When Ordering
  - Requires -M Manifold Drain Assembly
  - Add **SU-15 \$1064** for Filler Faucet Provision
- K-49 \$546**



### HEAVY DUTY Refrigerated Cold Well Tables

- Heavy Duty Construction 300 Stainless Steel Body, Top & Legs
- Adjustable Stainless Steel Bullet Feet
- Heavy Duty Cabinet Base
- 1" I.P.S. Drain
- Poly Cutting Board Shelf - Ships K.D.
- High Cooling Capacity
- Includes Adapter Bars For Optional Spillage Pans
- Low Running Current
- Precision Thermostat For Exact Temperature Control
- Single Phase Wiring
- 8 Ft. Electric Cord w/ Plug Included



**Enclosed Base**  
HDRCP-3-BS Shown  
with Optional TA-255P Casters

Model #	Price	Length	Width*	Refrigerant	Wt.	Cu. Ft.
HDRCP-2-BS	\$20228	31-13/16"	36-1/4"	R404-A	300 lbs.	39
HDRCP-3-BS	21217	47-1/8"	36-1/4"	R404-A	420 lbs.	56
HDRCP-4-BS	23575	62-7/16"	36-1/4"	R404-A	510 lbs.	73
HDRCP-5-BS	27504	77-3/4"	36-1/4"	R404-A	568 lbs.	90
HDRCP-6-BS	30256	93-1/16"	36-1/4"	R404-A	633 lbs.	90

\*Width Includes 8" Cutting Board

**SU-71** 5 Year Extended Parts Warranty on Refrigeration Unit **\$710 Per Unit**  
(Available for Refrigerated Tables & Drop-Ins.  
See Back Inside Cover For Full Details)



#### CONNECT IT!

Prepare Tables To Be Locked Together  
While Keeping Them Lined Up!

(One Charge For Each Table To Be Interlocked)

**SU-19 \$791 per table**

**WARNING:** Refrigerated Equipment on this page may expose you to chemicals, including Ethanes, that are known to the State of California to cause cancer or birth defects or other reproductive harm. For more info, visit [www.p65warnings.ca.gov](http://www.p65warnings.ca.gov).

### HEAVY DUTY ICE-COOLED TABLES

- Stainless Steel Body, Top And Legs
- Adjustable Stainless Steel Bullet Feet
- High Cooling Capacity
- Heavy Duty Cabinet Base
- 8" Wide Poly Cutting Board Shelf - Ships K.D.



**Enclosed Base**  
HDCPU-3-BS Shown  
with Optional TA-255P Casters



#### Enclosed Base

Model #	Price	Length	Width*	Wt.	Cu. Ft.
HDCPU-2-BS	\$9906	31-13/16"	36-1/4"	117 lbs.	27
HDCPU-3-BS	11724	47-1/8"	36-1/4"	145 lbs.	39
HDCPU-4-BS	12676	62-7/16"	36-1/4"	205 lbs.	58
HDCPU-5-BS	15708	77-3/4"	36-1/4"	250 lbs.	69
HDCPU-6-BS	17197	93-1/16"	36-1/4"	295 lbs.	81

#### With Doors

Model #	Price	Length	Width*	Wt.	Cu. Ft.
HDCPU-2-DR	\$10229	31-13/16"	36-1/4"	127 lbs.	27
HDCPU-3-DR	12330	47-1/8"	36-1/4"	155 lbs.	39
HDCPU-4-DR	13053	62-7/16"	36-1/4"	215 lbs.	58
HDCPU-5-DR	16265	77-3/4"	36-1/4"	264 lbs.	69
HDCPU-6-DR	17893	93-1/16"	36-1/4"	309 lbs.	81

\*Width Includes 8" Cutting Board

See Pages 137-140 For Shelving & Accessories!

# BUFFET TABLES

## Everyday Buffet Hot Food Tables

For Use with Optional Spillage Pans

- Stainless Steel Top And Body
- Matte Black Vinyl Clad
- 8" Deep Liners For Optional SP-A Or SP-S Spillage Pans
- 1/4" Thick, Double Sided Thermoplastic Polymer Sneeze Guard & Side Panels
- 4" Swivel Casters, Two With Brakes
- Fiberglass Insulation
- Pre-Drilled For Optional Solid Drop-Down Tray Shelf available for one or both sides

- Infinite Control Knobs
- Indicator Lights
- 8 Ft. Electric Cord w/ Plug Included
- Single Phase Wiring (Upgrade to 3 Phase Wiring for 240 Volt Units- **Model # SU-72 \$690**)
- To Omit Sneeze Guard use **Model # BSG-OMIT** deduct **\$397**



**Open Base**  
B3-120-B-S Shown

### Open Base

Galvanized Liners	Price	Stainless Steel Liners	Price	Length	# of Wells	NEMA Plug	Volts	Amps	Watts	Wt.	Cu. Ft.
B2-120-B	\$6029	B2-120-B-S	\$6757	31-13/16"	2	5-20P	120	8.33	1000	135 lbs.	39
B3-120-B	6613	B3-120-B-S	7085	47-1/8"	3	5-20P	120	12.50	1500	246 lbs.	56
B4-120-B	7488	B4-120-B-S	8183	62-7/16"	4	L5-30P	120	16.67	2000	301 lbs.	73
B2-240-B	6029	B2-240-B-S	6757	31-13/16"	2	6-20P	208/240	7.21/8.33	1500/2000	135 lbs.	39
B3-240-B	6402	B3-240-B-S	7085	47-1/8"	3	6-20P	208/240	10.82/12.50	2250/3000	170 lbs.	57
B4-240-B	7488	B4-240-B-S	8183	62-7/16"	4	L6-30P	208/240	14.42/16.67	3000/4000	310 lbs.	73
B5-240-B	9233	B5-240-B-S	9673	77-3/4"	5	L6-30P	208/240	18.03/20.84	3750/5000	343 lbs.	90

### Enclosed Base

Galvanized Liners	Price	Stainless Steel Liners	Price	Length	# of Wells	NEMA Plug	Volts	Amps	Watts	Wt.	Cu. Ft.
B2-120-B-SB	\$7526	B2-120-B-S-SB	\$7889	31-13/16"	2	5-20P	120	8.33	1000	135 lbs.	39
B3-120-B-SB	8330	B3-120-B-S-SB	8878	47-1/8"	3	5-20P	120	12.50	1500	170 lbs.	56
B4-120-B-SB	9134	B4-120-B-S-SB	10058	62-7/16"	4	L5-30P	120	16.67	2000	310 lbs.	73
B2-240-B-SB	7526	B2-240-B-S-SB	7889	31-13/16"	2	6-20P	208/240	7.21/8.33	1500/2000	135 lbs.	39
B3-240-B-SB	8330	B3-240-B-S-SB	8878	47-1/8"	3	6-20P	208/240	10.82/12.50	2250/3000	170 lbs.	56
B4-240-B-SB	9134	B4-240-B-S-SB	10058	62-7/16"	4	L6-30P	208/240	14.42/16.67	3000/4000	210 lbs.	73
B5-240-B-SB	10507	B5-240-B-S-SB	11325	77-3/4"	5	L6-30P	208/240	18.03/20.84	3750/5000	235 lbs.	90



**Enclosed Base**  
B3-120-B-SB Shown

## BUFFET TABLE SEALED WELL WITH ENCLOSED BASE

- Stainless Steel Top And Body
- Stainless Steel Sealed Wells with Manifold Drains
- Matte Black Vinyl Clad
- 10 Gauge Aluminum Dome Shape Heat Element
- 20 Gauge Stainless Steel Deep Drawn Bowls With 1" Drain
- 1/4" Thick, Double Sided Thermoplastic Polymer Sneeze Guard And Side Panels
- 4" Swivel Casters, Two With Brakes
- Fiberglass Insulation

- Optional Solid Drop-Down Tray Shelf available for one or both sides
- Infinite Control Knobs
- Indicator Lights
- Single Phase Wiring
- Single Phase Wiring (Upgrade to 3 Phase Wiring for 240 Volt Units- **Model # SU-72 \$690**)
- 8 Ft. Electric Cord w/ Plug Included
- To Omit Sneeze Guard use **Model # BSG-OMIT** deduct **\$397**



**Enclosed Base**  
BSW3-120-B-SB Shown

### Enclosed Base

Stainless Steel Liners	Price	Length	# of Wells	NEMA Plug	Volts	Amps	Watts	Wt.	Cu. Ft.
BSW2-120-B-SB	\$8952	31-13/16"	2	5-20P	120	10.67	1280	300 lbs.	30
BSW3-120-B-SB	9556	47-1/8"	3	5-20P	120	16	1920	325 lbs.	43
BSW4-120-B-SB	10776	62-7/16"	4	L5-30P	120	21.33	2560	356 lbs.	55
BSW2-240-B-SB	8952	31-13/16"	2	6-20P	208/240	7.94/9.16	1650/2200	300 lbs.	30
BSW3-240-B-SB	9556	47-1/8"	3	6-20P	208/240	11.91/13.74	2475/3300	325 lbs.	43
BSW4-240-B-SB	10776	62-7/16"	4	L6-30P	208/240	15.88/18.32	3300/4400	356 lbs.	55
BSW5-240-B-SB	12574	77-3/4"	5	L6-30P	208/240	19.85/22.90	4125/5500	370 lbs.	68

**NOTE: Units are not designed to cook or heat frozen or refrigerated foods. Food placed in tables should already be hot, and the table will maintain the proper temperatures**

See Pages 137-140 For Shelving & Accessories!

### END SHELF FOR HOT/COLD TABLES

(Excludes HDSW, HDRCP & HDCPU Units)

- 10" Wide x 22 1/2" Length
- Stainless Steel

Stationary	Drop-Down
TES-1	TES-1D
<b>\$1013</b>	<b>\$1195</b>





# BUFFET TABLES

## Everyday Buffet Ice-Cooled Tables

For Use with Optional Spillage Pans

- Stainless Steel Top And Body
- Matte Black Vinyl Clad
- 9" Deep Liners With Adapter Bars For Optional **SP-A** Or **SP-S** Spillage Pans
- 1/4" Thick, Double Sided Thermoplastic Polymer Sneeze Guard And Side Panels
- 4" Swivel Casters, Two With Brakes
- Fiberglass Insulation
- Pre-Drilled For Optional Solid Drop-Down Tray Shelf available for one or both sides
- To Omit Sneeze Guard use **Model # BSG-OMIT** deduct **\$397**

### Open Base

Model	Price	Length	# of Wells	Wt.	Cu. Ft.
B2-CPU-B	<b>\$5653</b>	35-15/18"	2	252 lbs.	59
B3-CPU-B	<b>6182</b>	53-1/9"	3	280 lbs.	85
B4-CPU-B	<b>6714</b>	69-8/18"	4	347 lbs.	109
B6-CPU-B	<b>7690</b>	86-3/4"	6	392 lbs.	133



**Open Base**  
B3-CPU-B Shown

### Enclosed Base

Model	Price	Length	# of Wells	Wt.	Cu. Ft.
B2-CPU-B-SB	<b>\$6383</b>	35-15/18"	2	263 lbs.	59
B3-CPU-B-SB	<b>6619</b>	53-1/9"	3	291 lbs.	85
B4-CPU-B-SB	<b>7236</b>	69-8/18"	4	358 lbs.	109
B6-CPU-B-SB	<b>8368</b>	86-3/4"	6	403 lbs.	133



**Enclosed Base**  
B3-CPU-B-SB Shown

**NOTE: Units are not designed to cool foods originally warm. Food should already be chilled to maintain the proper temperatures**

## Everyday Buffet Tables with Solid Top

- Stainless Steel Top And Body
- Solid Stainless Steel Top
- Matte Black Vinyl Clad
- 1/4" Thick, Double Sided Thermoplastic Polymer Sneeze Guard on top and side panels and Side Panels
- 4" Swivel Casters, Two With Brakes
- Optional Solid Drop-Down Tray Shelf available for one or both sides
- To Omit Sneeze Guard use **Model # BSG-OMIT** deduct **\$397**

### Open Base

Model	Price	Length	Wt.	Cu. Ft.
B2-STU-B	<b>\$5843</b>	35-15/18"	291 lbs.	59
B3-STU-B	<b>6249</b>	53-1/9"	336 lbs.	85
B4-STU-B	<b>7019</b>	69-8/18"	370 lbs.	109
B6-STU-B	<b>8028</b>	86-3/4"	414 lbs.	133



**Open Base**  
B3-STU-B Shown

### ENCLOSED BASE

Model	Price	Length	Wt.	Cu. Ft.
B2-STU-B-SB	<b>\$6212</b>	36"	302 lbs.	59
B3-STU-B-SB	<b>7016</b>	53"	347 lbs.	85
B4-STU-B-SB	<b>7824</b>	70"	381 lbs.	109
B6-STU-B-SB	<b>8264</b>	87"	426 lbs.	133



**Enclosed Base**  
B3-STU-B-SB Shown

**See Pages 137-140 For Shelving & Accessories!**

# BUFFET TABLES

## Mechanically Assisted Everyday Buffet Tables

For Use with Optional Spillage Pans



### COLD PAN TABLES WITH ENCLOSED BASE

- Stainless Steel Top, Liner And Body
- Self contained condensing unit provided with a hermetically sealed compressor with a digital, programmable thermostat
- Full Insulation With 22 Gauge Galvanized Outer Jacket
- Removable access door to compressor
- Fiberglass Insulation
- High Cooling Capacity
- Sight Glass To Ensure Properly Charges System
- Low Running Current
- Precision Thermostat For Exact Temperature Control
- 1" I.P.S. Drain

- 1/4" Thick, Double Sided Thermoplastic Polymer Sneeze Guard And Side Panels
- 4" Swivel Casters, Two With Brakes
- Includes Food Pan Adapters For optional 12" X 20" Pans
- Matte Black Vinyl Clad
- Pre-Drilled For Optional Solid Drop-Down Tray Shelf available for one or both sides
- Single Phase Wiring
- 8 Ft. Electric Cord w/ Plug Included
- To Omit Sneeze Guard use **Model # BSG-OMIT** deduct **\$397**



**Enclosed Base**  
BMACP3-B-SB Shown

Model	Price	Length	# of Wells	NEMA Plug	Refrigerant	Wt.	Cu. Ft.
BMACP2-B-SB	<b>\$14353</b>	31-13/16"	2	5-20P	R404-A	250 lbs.	30
BMACP3-B-SB	<b>15338</b>	47-1/8"	3	5-20P	R404-A	300 lbs.	43
BMACP4-B-SB	<b>16129</b>	62-7/16"	4	5-20P	R404-A	345 lbs.	55
BMACP5-B-SB	<b>17177</b>	77-3/4"	5	5-20P	R404-A	395 lbs.	68

**NOTE: Units are not designed to cook or heat frozen or refrigerated foods. Food placed in tables should already be hot, and the table will maintain the proper temperatures**

**SU-71** 5 Year Extended Parts Warranty on Refrigeration Unit **\$710 Per Unit**  
(Available for Refrigerated Tables & Drop-Ins. See Back Inside Cover For Full Details)

**CONNECT IT!**  
Prepare Tables To Be Locked Together While Keeping Them Lined Up!  
(One Charge For Each Table To Be Interlocked)  
**SU-19 \$791 per table**

**WARNING:** Refrigerated Equipment on this page may expose you to chemicals, including Ethanes, that are known to the State of California to cause cancer or birth defects or other reproductive harm. For more info, visit [www.p65warnings.ca.gov](http://www.p65warnings.ca.gov).

### PORTABLE CASH REGISTER STANDS WITH DRAWER & KEY LOCK

- 20 Gauge, 304 Stainless Steel Frame
- Locking Drawer
- 4" Swivel Casters With Two Brakes
- Open Storage Area
- Matte Black Vinyl Clad



Add Holes For Power Cord (Requires 2)  
**TA-108 \$174 per hole**



Model	Price	Length	Width	Height	Wt.	Cu. Ft.
BCRS-B	<b>\$3528</b>	22 1/2"	22 1/2"	34 3/8"	140 lbs.	19

### WITH LOCKING DOOR

- Stainless Steel Interior, Frame And Bottom
- Adjustable Hinges & Locking Door w/ Key
- Full Perimeter Bumpers
- Mid-Shelf
- Black Mica Finish On Door, Top & Sides
- Open Bottom Shelf For Glass Rack Storage
- 4" Swivel Casters With Two Brakes



Model	Price	Length	Width	Height	Wt.	Cu. Ft.
AMD-2B	<b>\$3196</b>	24.5"	23.5"	40.5"	160 lbs.	27

### EVERYDAY BUFFET SILVERWARE STAND

- 20 Gauge, 304 Stainless Steel Frame
- Includes 12 Plastic Silverware Cups
- 4" Swivel Casters With Two Brakes
- Matte Black Vinyl Clad



(Trays & silverware shown not included)

Model	Price	Length	Width	Height	Wt.	Cu. Ft.
BSWS-B	<b>\$4300</b>	31.875"	22.4"	40"	160 lbs.	28

### Food Table Modifications & Accessories

For Our Full Line Of Hot Food Table Modifications, Accessories & Replacement Parts, See Page 137-140

TCB-OMIT	Remove Poly Cutting Board	<b>-\$227 ea.</b>	SU-45A	12" x 1" Adapter Bar	<b>80 ea.</b>
CB-OMIT	Remove Poly Cutting Board Only	<b>-113 ea.</b>	SU-45B	20" x 3" Adapter Bar	<b>90 ea.</b>
SU-6	Hot/Cold Food Table Handle	<b>\$248 ea.</b>	SU-72	Upgrade 240 volt units to 3-Phase Wiring	<b>690 ea.</b>
SU-6-B	Everyday Buffet Handle	<b>\$248 ea.</b>	SP-A	Aluminum Spillage Pan	<b>183 ea.</b>
SU-6-HD	Heavy Duty Hot/Cold Food Table Handle	<b>\$248 ea.</b>	SP-S	Stainless Steel Spillage Pan	<b>321 ea.</b>
SU-19	Prepare Hot Tables To Be Locked Together (One Charge For Each Table To Be Interlocked)	<b>791 ea.</b>			



# ACCESSORIES

## Hot/Cold Food Table Shelving

### TRAY SHELVES

#### 10" Wide Stainless Steel Tray Shelves



STATIONARY			DROP-DOWN		
Model	Price		Model	Price	
TTS-2	\$1058		TTS-2D	\$1242	31-13/16" 15 lbs. 3
TTS-3	1251		TTS-3D	1444	47-1/8" 17 lbs. 4
TTS-4	1280		TTS-4D	1538	62-7/16" 19 lbs. 5
TTS-5	1536		TTS-5D	1717	77-3/4" 22 lbs. 6
TTS-6	1871		TTS-6D	2093	93-1/16" 25 lbs. 6

#### 12" Wide Stainless Steel Tray Rails



STATIONARY			DROP-DOWN		
Model	Price		Model	Price	
TTR-2	\$961		TTR-2D	\$1123	31-13/16" 14 lbs. 3
TTR-3	1180		TTR-3D	1354	47-1/8" 16 lbs. 4
TTR-4	1326		TTR-4D	1452	62-7/16" 18 lbs. 5
TTR-5	1540		TTR-5D	1672	77-3/4" 21 lbs. 6
TTR-6	1879		TTR-6D	2039	93-1/16" 23 lbs. 6

#### 8" WIDE SHELF

With Removable  
3/8" Thick Poly Cutting Board



- All Stainless Steel Construction
- Cutting Board Attaches To Top Shelf Using Acorn Nuts

Model	Price	Length	Approx Wt.	Cu. Ft.
TCB-2	\$458	31-13/16"	16 lbs.	3
TCB-3	620	47-1/8"	19 lbs.	4
TCB-4	778	62-7/16"	23 lbs.	5
TCB-5	905	77-3/4"	26 lbs.	6
TCB-6	1062	93-1/16"	29 lbs.	7

TCB-OMIT Remove Poly Cutting Board & Shelf **-\$227 ea.**  
 CB-OMIT Remove Poly Cutting Board Only **-113 ea.**

#### Replacement 3/8" Poly Cutting Boards



Model	Price	Length	Approx Wt.
SU-P-342	\$242	31-13/16"	9 lbs.
SU-P-343	294	47-1/8"	11 lbs.
SU-P-344	330	62-7/16"	13 lbs.
SU-P-345	352	77-3/4"	15 lbs.
SU-P-346	404	93-1/16"	18 lbs.

#### 7" WIDE DISH SHELF

Connects To TCB Series Shelf

Includes 2 Side Panels & Lower Shelf



Poly Cutting Board & Top Shelf Not Included

Model	Price	Length	Approx Wt.	Cu. Ft.
TDS-2	\$840	31-13/16"	20 lbs.	3
TDS-3	1003	47-1/8"	27 lbs.	4
TDS-4	1326	62-3/8"	31 lbs.	5
TDS-5	1528	77-3/4"	38 lbs.	6
TDS-6	1723	93-1/16"	45 lbs.	7

#### END SHELF FOR HOT/COLD TABLES

(Excludes HDRCP, HDSW & HDCPU Units)

- 10" Wide x 22 1/2" Length
- Stationary or Drop-Down
- All Stainless Steel Construction



STATIONARY		DROP-DOWN		Approx Wt.	Cu. Ft.
Model	Price	Model	Price		
TES-1	\$1013	TES-1D	\$1195	15 lbs.	3

#### TABLE MOUNTED OVERSHELVES

- TOS Series: Upper Shelf Secures To Lower Shelf With Expander Hardward (Included)
- Shipped KD

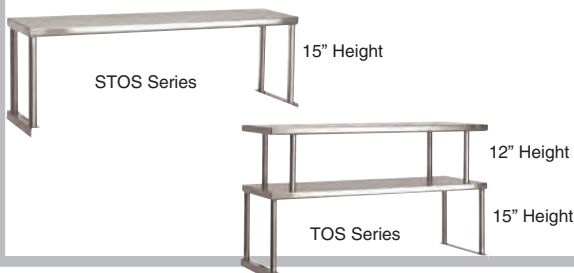

12" Wide			18" Wide		
Model	Price	Approx Wt.	Model	Price	Approx Wt.
<b>Single Tier</b>					
STOS-2	\$1208	18 lbs.	STOS-2-18	\$1536	20 lbs.
STOS-3	1372	21 lbs.	STOS-3-18	1653	23 lbs.
STOS-4	1544	24 lbs.	STOS-4-18	1790	26 lbs.
STOS-5	1672	27 lbs.	STOS-5-18	1954	30 lbs.
STOS-6	2039	33 lbs.	STOS-6-18	2383	35 lbs.
<b>Double Tier</b>					
TOS-2	2191	32 lbs.	TOS-2-18	2606	35 lbs.
TOS-3	2558	38 lbs.	TOS-3-18	3007	56 lbs.
TOS-4	2924	44 lbs.	TOS-4-18	3435	47 lbs.
TOS-5	3287	49 lbs.	TOS-5-18	3853	53 lbs.
TOS-6	4012	56 lbs.	TOS-6-18	4703	61 lbs.

# ACCESSORIES

## Hot/Cold Food Table Food Shields



Meets Latest NSF Standards

### Sleek Shields™

Protected By: Patent No. US 9,010,883 B2



FEATURING ADVANCE TABCO'S REVOLUTIONARY CHAMBER LOCK™ ROTATION SYSTEM

Front Glass Locks Into Place At 15° Intervals

For Double Sided Sleek Shields™  
On Everyday Buffets Please Consult Factory

### GLASS FOOD SHIELDS

Mounts To Top Of Hot/Cold Food Tables On Pgs. 127-135  
(Excluding Drop-In Wells)

- 18 3/4" Standard Height (Top of Table To Top)
- 15" Wide Glass Top or Stainless Steel Shelf
- NSG/NSGC Models: Shelves Have Square Edges On All Four Sides.
- GSG Models: Glass Top Features 3/8" Heat-Tempered Glass Top
- 1" Stainless Steel Tubing Posts
- Includes Two 18" Wide x 16 3/8" High Glass Side Panels
- 1/4" Thick Heat-Tempered Glass Front & Sides\*
- Ships KD



NSG-15-4WELL Shown

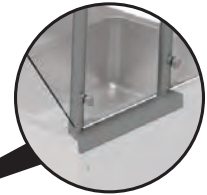

Includes TA-47  
Mounting Brackets  
For In-Field Installation

### Self-Serve - Single Side

15" Wide Stainless Steel Shelf			15" Wide w/ Glass Top			Fits # of Bowls	Approx. Wt.	Approx. Cubes
Model #	Price	O.A. Size L x W x H	Model #	Price	O.A. Size L x W x H			
NSG-15-2WELL	\$4826	33 11/16" x 19 3/4" x 18 3/4"	GSG-15-2WELL	\$5790	33 11/16" x 19 3/4" x 18"	Fits 2-Well Unit	109 lbs.	15
NSG-15-3WELL	5024	49" x 19 3/4" x 18 3/4"	GSG-15-3WELL	6008	49" x 19 3/4" x 18"	Fits 3-Well Unit	143 lbs.	22
NSG-15-4WELL*	5881	64 5/16" x 19 3/4" x 18 3/4"	GSG-15-4WELL*	6392	64 5/16" x 19 3/4" x 18"	Fits 4-Well Unit	186 lbs.	29
NSG-15-5WELL**	6423	79 5/8" x 19 3/4" x 18 3/4"	Not Available	Not Available	Not Available	Fits 5-Well Unit	215 lbs.	38
NSG-15-6WELL**	7114	94 15/16" x 19 3/4" x 18 3/4"	Not Available	Not Available	Not Available	Fits 6-Well Unit	247 lbs.	47

\*3/8" Thick Heat-Tempered Glass Required For Front Glass \*\*Requires a Single Center Post (Factory Print Included)

### Cafeteria Style - Single Side

15" Wide Stainless Steel Shelf			Fits # of Bowls	Approx. Wt.	Approx. Cubes
Model #	Price	O.A. Size L x W x H			
NSGC-15-2WELL	\$5789	33 11/16" x 18" x 18 3/4"	Fits 2-Well Unit	135 lbs.	15
NSGC-15-3WELL	5962	49" x 18" x 18 3/4"	Fits 3-Well Unit	176 lbs.	22
NSGC-15-4WELL*	6531	64 5/16" x 18" x 18 3/4"	Fits 4-Well Unit	232 lbs.	29
NSGC-15-5WELL**	6949	79 5/8" x 18" x 18 3/4"	Fits 5-Well Unit	265 lbs.	38
NSGC-15-6WELL**	7773	94 15/16" x 18" x 18 3/4"	Fits 6-Well Unit	300 lbs.	47

\*3/8" Thick Heat-Tempered Glass Required For Front Glass \*\*Requires a Center Leg (Factory Print Included)

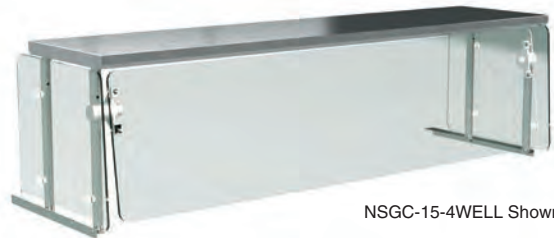

NSGC-15-4WELL Shown

For Sleek Shield™ Modifications, Accessories  
and Heat Lamps, See Page 73

Due to mounting requirements, food shields extend 15/16" beyond the end of the hot or cold table on each end. Units set side by side must allow for this additional space.

### Self-Serve -Double Sided

- 18 3/4" Standard Height (Top of Table To Top)
- 22 3/4" Wide Stainless Steel Shelf with Square Edges On All Four Sides.
- 1" Stainless Steel Tubing Posts
- Includes Two 16 3/8" High Glass Side Panels
- 1/4" Thick Heat-Tempered Glass Front & Sides
- Ships Set Up

25" Wide Stainless Steel Shelf			Fits # of Bowls	Approx. Wt.	Approx. Cubes
Model #	Price	O.A. Size L x W x H			
NSGD-26-2WELL	\$8217	33 1/16" x 32 1/4" x 18 3/4"	Fits 2-Well Unit	285 lbs.	20
NSGD-26-3WELL	8439	49" x 32 1/4" x 18 3/4"	Fits 3-Well Unit	340 lbs.	27
NSGD-26-4WELL*	9408	64 5/16" x 32 1/4" x 18 3/4"	Fits 4-Well Unit	425 lbs.	36
NSGD-26-5WELL**	9599	79 5/8" x 32 1/4" x 18 3/4"	Fits 5-Well Unit	515 lbs.	44
NSGD-26-6WELL**	10229	93-1/8" x 32 1/4" x 18 3/4"	Fits 6-Well Unit	605 lbs.	54

\*3/8" Thick Heat-Tempered Glass Required For Front Glass \*\*Requires a Single Center Post (Factory Print Included)



NSGD-26-4WELL Shown

Due to mounting requirements, food shields extend 15/16" beyond the end of the hot or cold table on each end. Units set side by side must allow for this additional space.

# ACCESSORIES

## Hot & Cold Table Accessories

### CAFETERIA SHELVES w/ BUILT-IN ACRYLIC FOOD SHIELDS

Features Removable Stainless Steel Shelf

#### Single Sided Cafeteria Style

- 15" High
- 1" Clearance From Table Top

Model	Price	Length	Approx Wt.	Cu. Ft.
TSS-2	<b>\$1503</b>	31-13/16"	17 lbs.	2
TSS-3	<b>1711</b>	47-1/8"	20 lbs.	3
TSS-4	<b>1866</b>	62-7/16"	23 lbs.	4
TSS-5	<b>2003</b>	77-3/4"	33 lbs.	4
TSS-6	<b>2393</b>	93-1/16"	33 lbs.	5



#### Double Sided Self-Serve Style

- 19-3/4" High
- 10" Clearance From Table Top

Model	Price	Length	Approx Wt.	Cu. Ft.
TBS-2	<b>\$2386</b>	31-13/16"	28 lbs.	2
TBS-3	<b>2463</b>	47-1/8"	33 lbs.	3
TBS-4	<b>2688</b>	62-7/16"	38 lbs.	4
TBS-5	<b>3078</b>	77-3/4"	45 lbs.	4
TBS-6	<b>3346</b>	93-1/16"	52 lbs.	5

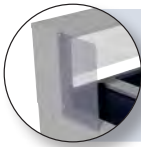

#### Acrylic Side Panel for TSS Series Shelves

Add Side Panels To Meet Additional NSF Requirements (1 Panel Per End)

Field Installation Available

TSP-1 **\$380 One End**  
TSP-2 **\$779 Two Ends**



#### Acrylic Side Panel for TBS Series Shelves

Add Side Panels To Meet Additional NSF Requirements (2 Panels Per End)

Field Installation Available

TBP-1 **\$458 One End**  
TBP-2 **\$913 Two Ends**

## LED Display Lighting

### For Everyday Buffets & Hot/Cold Table Shelving



LED-B Series  
For Everyday Buffets



LED-H Series  
For Overshelves or Food Shields

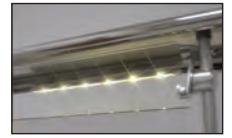

LED-G Series  
For GSG Series Food Shields

- Aluminum Rail with Shatter-Proof Optics
- Natural Aluminum Finish (Black or White Available On Request)
- Includes Class 2 Low Voltage Power Supply 120V-277V
- High Impact Resistant Mounting Clips

**NOTE:** Require 6" clearance on both sides to fit above LED Lighting. **PRINT REQUIRED FOR PROPER LED LOCATION. FACTORY INSTALLED ONLY**

Fits # of Wells	For use with Everyday Buffets		For use with STOS, TOS, TBS, TSS, NSG or NSGC Overshelves or Food Shields		For use with GSG Food Shields		LED Length
	Model #	Price	Model #	Price	Model #	Price	
2	LED-B-2	<b>\$2075</b>	LED-H-2	<b>\$2075</b>	LED-G-24	<b>\$944</b>	24"
3	LED-B-3	<b>2433</b>	LED-H-3	<b>2433</b>	LED-G-36	<b>1045</b>	36"
4	LED-B-4	<b>2794</b>	LED-H-4	<b>2794</b>	LED-G-48	<b>1139</b>	48"
5	LED-B-5	<b>3200</b>	LED-H-5	<b>3199</b>	Consult Factory		60"
6	Not Available		LED-H-6	<b>3620</b>	Consult Factory		72"

#### Individual Well Covers For Hot Food Tables

- Stainless Steel
- Removable
- Fits All Advance Tabco Hot Well Units



HFC-1 **\$502 Per Well**

#### Flip-Up Cover For Hot Food Tables

- Stainless Steel
- Removable
- Fits Advance Tabco Hot Well Units



Model #	Price	Fits # of		
		Comp.	Wt.	Cu.
RC-1	<b>\$1044</b>	1	23	5
RC-2	<b>1180</b>	2	60	10
RC-3	<b>1360</b>	3	74	15
RC-4*	<b>1896</b>	4	120	20
RC-5**	<b>2114</b>	5	134	25

\* Supplied with Two RC-2 Covers

\*\* Supplied with One RC-2 & One RC-3 Cover

#### Hinge Style Cover For Cold Food Tables

- Stainless Steel
- Plastic Handles & Piano Style Hinge(s)
- Fits CPU, DICP & MACP & BMAPC Units

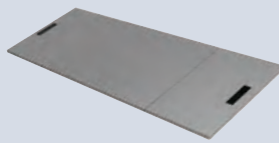

Model #	Price	Fits # of		
		Comp.	Wt.	Cu.
HC-2	<b>\$553</b>	2	12	3
HC-3	<b>827</b>	3	16	4
HC-4	<b>905</b>	4	20	5
HC-5	<b>1051</b>	5	24	6

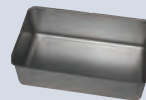

SP-A



TA-255P



SU-25S

#### Stainless Steel Legs & Undershelf Upgrade

2 Wells	3 Wells	4 Wells	5 Wells
SU-23A <b>\$1080</b>	SU-23B <b>\$1117</b>	SU-23C <b>\$1185</b>	SU-23D <b>\$1332</b>

SU-6	Hot/Cold Food Table Handle	<b>\$248 ea.</b>
SU-25S	Add Casters to Food Units w/Undershelf (Includes 4 - 5" Swivel Casters, 2 w/ Brakes & Legs that maintain height)	<b>646 Set of 4</b>
SU-25	Add Casters to Food Units w/Undershelf (For Units Built Before October 2015. Includes 4 - 5" Swivel Casters, 2 w/ Brakes.)	<b>594 Set of 4</b>
SU-19	Connect Cafeteria Items (One Charge For Each Table To Be Interlocked)	<b>791 per table</b>
TA-25	Replacement Casters For Undershelf Units (For Units Built after October 2015. Includes 4 - 5" Swivel Casters, 2 w/ Brakes.)	<b>594 Set of 4</b>
TA-255P	Add Casters to Enclosed Base Food Units (Includes 4 - 5" Bolted Swivel Casters, 2 w/ Brakes)	<b>934 Set of 4</b>
SU-32G	Upgrade to a Stainless Steel Lining (For Gas Units. Excludes Wetbath Units)	<b>168 per well</b>
SP-A	Aluminum Spillage Pan	<b>183 ea.</b>
SP-S	Stainless Steel Spillage Pan	<b>321 ea.</b>
TCB-OMIT	Remove Poly Cutting Board & Shelf	<b>-227 ea.</b>
CB-OMIT	Remove Poly Cutting Board	<b>-113 ea.</b>

# REPLACEMENT PARTS

## Replacement Parts For Hot Food Tables

 All Items on This Page Ship via UPS

### FOR GAS HOT FOOD TABLES



#### Gas Valve

Hi/Med/Lo

SU-P-101 **\$111**



#### Valve Adapter

SU-P-104 **\$65**



#### Gas Pilot Valve

SU-P-108 **\$81**



#### Gas Regulator

SU-P-109 **\$152**



#### Jet Burners

SU-P-105 **\$173**

NAT 5/16 #61

SU-P-106 **\$173**

LP 5/16 #74



#### Gas Pilot

For Wet Bath Units

SU-P-107 **\$267**

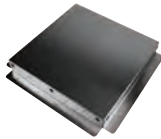

#### Gas Deflector

SU-P-411 **\$47**

Standard HFxG Units

SU-P-412 **\$69**

Stainless For SU-32G Wells



#### Pilot Assembly

HF-xG

SU-P-102 **\$125**



#### Gas Infinite Control Knob

SU-P-202 **\$63**



#### 1 1/2" Drain

Stainless Steel

For Wetbath Tables

SU-P-103 **\$90**

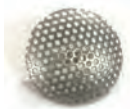

#### Strainer Screen

For Sealed Well Tables

SU-P-403 **\$29**

### FOR ELECTRIC HOT FOOD TABLES

#### ELECTRIC HEATING ELEMENTS

##### For Exposed Element (Dry) Models

SU-P-207 **\$173**

500W 120V

SU-P-204 **\$173**

1000W 240V



##### For Concealed Element Sealed Well (Wet) Models

SU-P-209 **\$197**

640W 120V

SU-P-206 **\$197**

1100W 240V

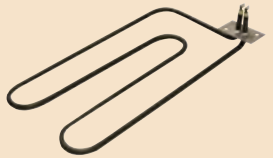

SU-P-210 **\$197**

1100W 120V - For Drop-In Units Only

#### Thermostatic Control

##### Replacement Thermostatic Control

SU-P-220A **\$312 Per Well**

120v/240v, 24" lead For Free-Standing Sealed Well Hot Food Units

SU-P-220B **\$312 Per Well**

120v/240v, 72" lead For Drop-In Sealed Well Hot Food Units

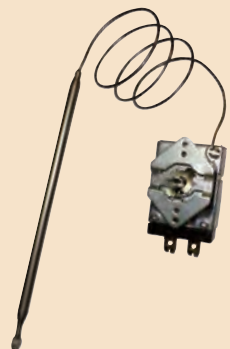

#### Electric Infinite Control Knob

SU-P-201 **\$63**



#### Thermostatic Knob

(For Units with Thermostatic Control)

SU-P-219 **\$68**

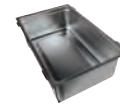

#### Replacement Sealed Well Sub-Assembly

SU-P-401 **\$1064**

Without Element or High Limit Switch



SU-P-402 **\$62**

Sealed Well or Element Pan Only

#### NEMA Plugs

8' Cord Set



SU-P-230 **\$144**

NEMA 5-20P



SU-P-231 **\$400**

NEMA L5-30P

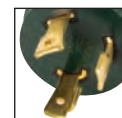

SU-P-232 **\$144**

NEMA 6-20P



SU-P-233 **\$400**

NEMA L6-30P



SU-P-234 **\$223**

NEMA 5-15



#### Infinite Control

SU-P-205 **\$151**

120V

SU-P-215 **\$151**

240V



#### Indicator Lights

SU-P-216 **\$109**

120V

SU-P-217 **\$109**

240V



#### High Limit Switch Assembly

SU-P-208 **\$233**

347F

# ALUMINUM RACKS

## Aluminum Pan Racks



FRONT LOAD

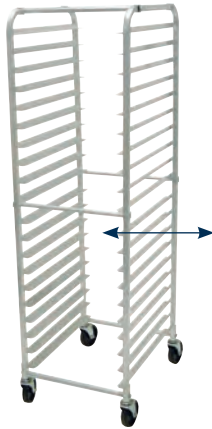

SIDE LOAD

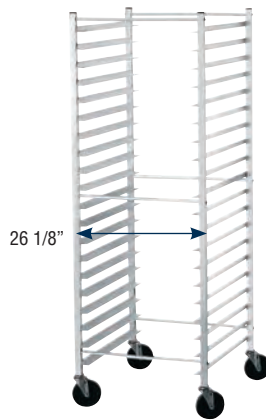

### K.D. PAN RACKS

- 6 Cylindrical Support Bars
- 1" Square Tubing
- 5" Poly Stem Bolted Casters
- 1 1/2" Ribbed Angles
- Shipped K.D.
- Easy To Assemble

Model #	Price	Description	Pan Capacity	Shelf Spacing	Overall Size	Approx. Wt.
PR10-3K	\$849	Front Load	10 Full or 20 Half Size	3"	20 1/4" x 26" x 38 1/4"	14 lbs.
PR12-5K	893	Front Load	12 Full or 24 Half Size	5"	20 1/4" x 26" x 69 1/4"	24 lbs.
PR18-3K	1066	Front Load	18 Full or 36 Half Size	3"	20 1/4" x 26" x 63 1/4"	31 lbs.
PR20-3K	1008	Front Load	20 Full or 40 Half Size	3"	20 1/4" x 26" x 69 1/4"	33 lbs.
PR30-2K	1080	Front Load	30 Full Size	2"	20 1/4" x 26" x 69 1/4"	39 lbs.
PR18-3KS	1002	Side Load	18 Full Size	3"	28 1/4" x 18" x 63 1/4"	31 lbs.
PR20-3KS	1051	Side Load	20 Full Size	3"	28 1/4" x 18" x 69 1/4"	27 lbs.

SEE PAGE 146  
FOR  
PROPER  
REPLACEMENT  
CASTERS



### ALL WELDED - CURVED TOP - STANDARD

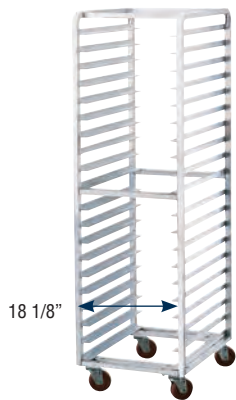

SIDE LOAD



FRONT LOAD

- Heavy Duty Welded Construction
- 1" Square Tubing
- Curved Top
- 5" Poly Stem Bolted Casters
- 6 Cross Supports
- 1 1/2" Heavy Duty Ribbed Angles

Model #	Price	Description	Pan Capacity	Shelf Spacing	Overall Size	Approx. Wt.
PR10-3W	\$1005	Front Load	10 Full or 20 Half Size	3"	20 1/4" x 26" x 38 1/2"	25 lbs.
PR10-6W	1162	Front Load	10 Full or 20 Half Size	6"	20 1/4" x 26" x 69 1/4"	27 lbs.
PR12-5W	1183	Front Load	12 Full or 24 Half Size	5"	20 1/4" x 26" x 69 1/4"	28 lbs.
PR15-4W	1198	Front Load	15 Full or 30 Half Size	4"	20 1/4" x 26" x 69 1/4"	31 lbs.
PR18-3W	1219	Front Load	18 Full or 36 Half Size	3"	20 1/4" x 26" x 63 1/4"	34 lbs.
PR20-3W	1232	Front Load	20 Full or 40 Half Size	3"	20 1/4" x 26" x 69 1/4"	35 lbs.
PR30-2W	1444	Front Load	30 Full or 60 Half Size	2"	20 1/4" x 26" x 69 1/4"	43 lbs.
PR10-6WS	1318	Side Load	10 Full Size	6"	28 1/4" x 18" x 69 1/4"	26 lbs.
PR12-5WS	1334	Side Load	12 Full Size	5"	28 1/4" x 18" x 69 1/4"	27 lbs.
PR15-4WS	1476	Side Load	15 Full Size	4"	28 1/4" x 18" x 69 1/4"	30 lbs.
PR18-3WS	1511	Side Load	18 Full Size	3"	28 1/4" x 18" x 63 1/4"	27 lbs.
PR20-3WS	1527	Side Load	20 Full Size	3"	28 1/4" x 18" x 69 1/4"	34 lbs.

# ALUMINUM RACKS

## Specialty Racks

### ENCLOSED PAN CABINETS

- 14 Ga. Aluminum, Heavy Duty Welded Construction
  - Enclosed Extrusions
  - 5" Poly Plate Casters, 2 With Brakes
  - Flip Style Door Latch Handle
  - Side Door Lock to Prevent Opened Door From Swinging
  - 37 Pan Capacity
  - Optional Bumpers Available
  - Optional Pull Handle For Improved Mobility.
- Does Not Interfere With Other Side By Side Units.



Model #	Price	Description	Pan Capacity	Shelf Spacing	Overall Size	Approx. Wt.
EPC-40	\$3388	Front Load	37 Full or 74 Half Size	1 1/2"	20 1/2" x 27 1/2" x 66 1/4"	110 lbs.

### Optional Accessories

Model #	Description	Price
RA-21	Optional Pull Handle .....	\$490
RA-22	Full Perimeter Bumpers .....	342
RA-23	Corner Bumpers .....	273

### FULL & HALF SIZE CAN RACKS

Aluminum Top    Poly Top    Stainless Steel Top



Half Can Rack



Full Can Rack

Heavy Duty



Full Can Rack With Casters

### SPEC-LINE



- Heavy Duty Welded Construction
- Metal Bullet Feet on CR10-162 only
- 4" Plate Casters with two Brakes. Standard on all Can Racks EXCEPT CR10-162 (See CR10-162M).

Model #	Price	Description	Can Capacity		Overall Size	Approx. Wt.
			#10	#5		
CR10-162	\$2310	Full Can Rack	162	216	24 3/4" x 35 1/8" x 69 3/4"	65 lbs.
CR10-162M	2856	Full Can Rack (with Casters)	162	216	24 3/4" x 35 1/8" x 69 3/4"	76 lbs.
CR10-72	2237	Aluminum Top	72	96	24 3/4" x 35 1/8" x 40 1/8"	59 lbs.
CR10-54	1969	Aluminum Top	54	72	24 3/4" x 35 1/8" x 32 5/8"	54 lbs.
CRPL10-72	2467	Poly Top	72	96	24 3/4" x 35 1/8" x 40 1/8"	79 lbs.
CRPL10-54	2144	Poly Top	54	72	24 3/4" x 35 1/8" x 32 5/8"	74 lbs.
CRSS10-72	2353	Stainless Steel Top	72	96	24 3/4" x 35 1/8" x 40 1/8"	63 lbs.
CRSS10-54	2323	Stainless Steel Top	54	72	24 3/4" x 35 1/8" x 32 5/8"	55 lbs.



# ALUMINUM RACKS

## Aluminum Pan Racks



Front Load

### SPEC-LINE OVEN RACKS

Featuring High Temp Oven Plate Casters and All Welded Curved Top



- Heavy Duty Welded Construction
- 1" Square Tubing
- Curved Top
- 6 Cross Supports
- 4" Oven Plate Casters
- 1 1/2" Ribbed Angles

Model #	Price	Description	Pan Capacity	Shelf Spacing	Overall Size	Approx. Wt.
CFL20	\$2024	Front Load	20 Full or 40 Half Size	3"	20 1/4" x 26" x 68 5/8"	45 lbs.

### Optional Accessories



Model #	Description	Price
RA-10	Pan Stop.....	\$319
RA-20	Track Pin.....	248
ORL-B	Oven Lift .....	385

(For Front Load Pan Racks)

### REACH-IN RACKS

- All Welded Construction
- 1" Square Tubing
- Holds up to 16 Full or 32 Half Size Pans
- 3" Shelf Spacing
- 1" Front and Rear Cross Bracing
- Shipped KD



Model #	Price	Pan Capacity	Shelf Spacing	Approx. Wt.
RR-16	\$1056	16 Full or 32 Half Size	3"	23 lbs.

Consult Factory For All Welded Reach-In Racks

### BUS BOX RACK

- Heavy Duty Welded Construction
- Curved Top
- 5" Stem Bolted Casters
- Overall Size: 20 3/8" x 19" x 40 7/8"



Model #	Price	Bus Box Capacity	Approx. Wt.
BC3	\$831	3	18 lbs.

See Page 146  
For Aluminum Bun Pans



# SPECIALTY RACKS

## Specialty Racks

### PIZZA PAN & DOUGH RACKS

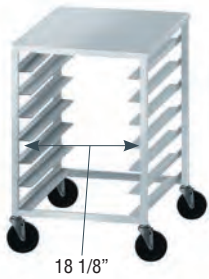

#### PDB7

- All Welded Construction
- Solid Aluminum Top
- 7 Box Capacity
- 3 3/4" Shelf Spacing
- 5" Poly Stem Bolted Casters
- 2" Wide Slides

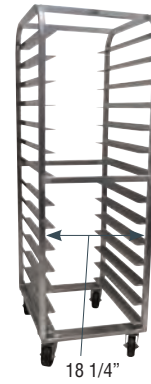

#### PDB14

- All Welded Construction
- No Top
- 14 Box Capacity
- 3 3/4" Shelf Spacing
- 4" Plate Casters
- 2" Wide Slides

Model #	Price	Description	Overall Size	Approx. Wt.
PDB7	\$1813	Pizza Dough Box Rack (With Top)	26" x 20 1/4" x 33 3/4"	33 lbs.

Model #	Price	Description	Overall Size	Approx. Wt.
PDB14	\$2629	Pizza Dough Box Rack (No Top)	26" x 20 1/4" x 61 1/2"	63 lbs.

PR10-3WT Shown



### HALF SIZE RACKS

- All Welded Construction
- 5" Poly Stem Bolted Casters
- 1-1/2" Ribbed Angles

#### PR7-4KT SERIES

- Removable Aluminum Top

PR7-4KT Shown



Model #	Price	Top	Description	Pan Capacity	Shelf Spacing	Overall Size	Approx. Wt.
PR7-4KT	\$1496	Aluminum Top	Front Load	7 Full/14 Half Size	3 3/4"	20 5/8" x 26 7/8 x 36"	28 lbs.
PR10-3WT	1562	Aluminum Top	Front Load	10 Full/20 Half Size	3"	20 1/4" x 26" x 38 1/2"	30 lbs.
PR10-3PT	1723	Poly Top	Front Load	10 Full/20 Half Size	3"	20 1/4" x 26" x 39"	45 lbs.
PR10-3ST	2031	Stainless Steel Top	Front Load	10 Full/20 Half Size	3"	20 1/4" x 26" x 39"	35 lbs.

\*Top shelf spacing on the PR7-4KT is 2-1/8"



### KEG RACKS

- 76" High, Aluminum Alloy Construction
- Shelves Are 1-3/4" Square Tubing
- 60 Lbs. Per Sq. Ft. Load Capacity Per Shelf
- Center Support Included On 93" Keg Shelves



#### Keg Rack Rear Strap

Prevents Kegs From Sliding Off Rear Of Keg Rack Shelf

Model #	Price	Size	# of Kegs (Per Unit)	Approx. Wt.
KR-42	\$1821	20" x 42"	4	50 lbs.
KR-60	1940	20" x 60"	6	68 lbs.
KR-72	2050	20" x 72"	8	80 lbs.
KR-80	2133	20" x 80"	8	88 lbs.
KR-93	2639	20" x 93"	10	100 lbs.

Model #	Price	Approx. Wt.
KR-1-42	\$213	6 lbs.
KR-1-60	237	7 lbs.
KR-1-72	239	8 lbs.
KR-1-80	265	9 lbs.
KR-1-93	288	10 lbs.

# ALUMINUM RACKS

## Specialty Racks

### SPECIAL PURPOSE RACKS

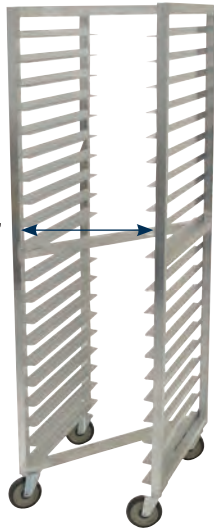

#### Nesting Pan Rack

**SPACESAVING DESIGN**

- Nested Design To Facilitate Maximum Storage In Minimum Space
- Heavy Duty Welded Construction With "Diagonal" Cross Supports
- 1 1/4" Square Tubing
- 1" X 1-1/2" Ribbed Angles
- Heavy Duty Stem Casters
- 500 Lb. Capacity

18 1/4"

#### Steam Table Pan Rack

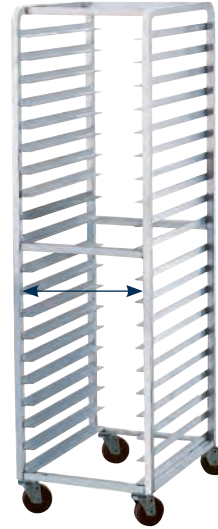

- Heavy Duty Welded Construction
- 1" Square Tubing
- Curved Top
- 6 Cross Supports
- 5" Poly Stem Bolted Casters

14 1/2"



Model #	Price	Pan Capacity	Shelf Spacing	Overall Size	Approx. Wt.
NR-20	1795	20 Full or 40 Half Size	3"	21" x 26" x 69 1/4"	29 lbs.

Model #	Price	Pan Capacity	Shelf Spacing	Overall Size	Approx. Wt.
STR20-3W	\$1744	20 Full or 40 Half Size	3"	16 3/4" x 21 1/4" x 69 1/4"	34 lbs.

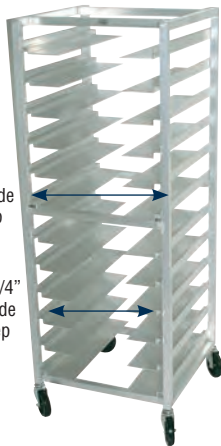

#### UNIVERSAL RACKS

- Heavy Duty Welded Construction
- 1-1/4" Square Tubing
- 6 Cross Supports
- Heavy Duty 5" Stem Bolted Casters
- Stepped Angles
- Overall Size: 26" x 26" x 69 1/4"
- Front Tray Load

23" Outside Step

20 3/4" Inside Step

#### TRAY RACKS

Holds Baking Pans, Steam Table Pans & Service Trays

- Heavy Duty Welded Construction
- 1-1/4" Square Tubing
- Heavy Duty 5" Poly Stem Bolted Casters
- 4" Wide Angles
- Overall Size: 26" x 28" x 69 1/4"
- Front Tray Load

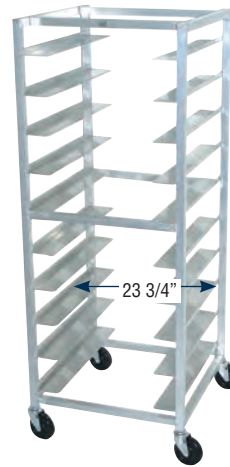

23 3/4"

Model #	Price	Pan Capacity	Shelf Spacing	Approx. Wt.
UR10	\$2360	10 Full or 20 Half Size	6"	86 lbs.
UR12	2440	12 Full or 24 Half Size	5"	100 lbs.

Model #	Price	Pan Capacity	Shelf Spacing	Approx. Wt.
OT20-3	2279	20 Full or 40 Half Size	3"	102 lbs.



#### LUG CARTS

- Heavy Duty Welded Construction
- 1" Square Tubing
- Curved Top
- 5" Stem Bolted Casters

Model #	Price	Lug Capacity	Overall Size L x W x H	Approx. Wt.
LR2	\$897	2	19" x 26" x 31 3/4"	18 lbs.
LR4	\$910	4	19" x 26" x 52 3/4"	21 lbs.
LR6	\$1012	6	19" x 26" x 69 3/4"	23 lbs.

# BUN PANS

## Bun Pans & Accessories



Look For Our Advertisized  
Specials on Sheet  
Pan Pricing

## ALUMINUM BUN PANS

 = All Bun Pans Ship via UPS

Model #	Price	Size	Style	Gauge	Approx. Wt.
18-A-26	<b>\$62 ea.</b>	18" x 26"	Heavy Duty	16	48 lbs.
18-8A-26	<b>53 ea.</b>	18" x 26"	Standard	18	40 lbs.
18-8P-26	<b>72 ea.</b>	18" x 26"	Perforated	18	33 lbs.
18-8A-13	<b>44 ea.</b>	18" x 13"	Half Size	18	24 lbs.

**Packed One Dozen per Carton.  
No splitting of CARTONS permitted.**

## PAN RACK ACCESSORIES

All Pan Rack Accessories Ship via UPS

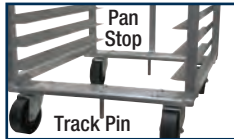

PRC-1



PRC-2

### Bun Pan Rack Covers with 3 Zippers

PRC-1 Enclosed Heavy Duty Plastic Cover.....**\$435 ea.**  
with Clear Front

PRC-2 Economy See-Thru Plastic Cover..... **321 ea.**

**For Full Line of Aluminum Pan Racks,  
See Page 141-145**

Model #	Description	Weight Capacity	Approx. Weight	Price
RA-10	Pan Stop	-	3 lbs.	<b>\$319</b>
RA-20	Track Pin	-	3 lbs.	<b>248</b>
RA-24	12" Vertical Bumpers (Set of 4)	-		<b>212</b>
RA-25	5" Stem Bolted Caster	125 lbs.	4 lbs.	<b>78 ea.</b>
RA-26	5" Stem Bolted Caster w/ Brake	125 lbs.	4 lbs.	<b>92 ea.</b>
RA-25SV	5" Stem Bolted Caster for PR1803K, PR20-3K   & PR12-5K ONLY	125 lbs.	4 lbs.	<b>78 ea.</b>
RA-26SV	5" Stem Bolted Caster w/Brake for PR1803K, PR20-3K & PR12-5K ONLY	125 lbs.	4 lbs.	<b>92 ea.</b>
RA-30	4" Plate Caster w/ Built-in Zerk Grease Fitting	400 lbs.	4 lbs.	<b>265 ea.</b>
RA-35	4" Plate Caster w/ Brake	400 lbs.	4 lbs.	<b>277 ea.</b>
RA-40	4" Hi-temp Oven Plate Casters w/ Built-in Zerk Grease Fitting	300 lbs.	4 lbs.	<b>188 ea.</b>
RA-45	4" Hi-Temp Oven Plate Caster w/ Brake	300 lbs.	4 lbs.	<b>206 ea.</b>
RA-50	3" Bun Pan Dolly Caster	250 lbs.		<b>85 ea.</b>
RA-60	5" Heavy Duty Stem Caster for Universal & Oval Racks Only.	300 lbs.	4 lbs.	<b>123 ea.</b>
RA-65	5" Heavy Duty Stem Caster with Brake for Universal & Oval Racks Only.	300 lbs.	4 lbs.	<b>136 ea.</b>
ORL-B	18" Oven Lift For Front Load Pan Racks	-	1 lbs.	<b>385 ea.</b>

# RACKS & CARTS

Racks & Carts

## PAN TRUCK

- Heavy Duty Welded Construction
- 1" Square Tubing
- Curved Top
- Heavy Duty 3" Plate Casters
- Holds 60 Full Size Pans
- 600 lb. Weight Capacity



Model #	Price	Size	Approx. Wt.
PD-1	<b>\$704</b>	20" x 26 1/2" x 32"	20 lbs.

## UTILITY CARTS

- 2 Chrome Plated Numbered Posts
- 3 Adjustable Stainless Steel Shelves with Tapered Split Sleeves
- 4 Swivel Casters (2 w/Brakes) & Donut Bumpers
- 150 lb. Load Capacity
- Shipped Knocked Down



Model #	Price	Size	Shelf Size	Approx. Wt.
UC-3-1827	<b>\$1990</b>	31 3/4" x 18" x 38 1/4"	18" x 27"	25 lbs.
UC-3-2433	<b>\$2597</b>	37 3/4" x 24" x 38 1/4"	24" x 33"	40 lbs.

## GLASS RACK & PAN RACK DOLLIES

### Bun Pan Dolly



- Heavy Duty Welded Construction
- 3" Plate Casters
- Holds 60 Full Size Pans
- 600 lb. Weight Capacity



### Glass Rack Dolly

- Heavy Duty Welded Construction
- 3" Plate Casters
- 600 lb. Weight Capacity



Model #	Price	Description	Size	Approx. Wt.
 BPD-1	<b>\$758</b>	Bun Pan Dolly	26 3/4" x 18 3/4" x 5"	15 lbs.
 GRD-1	<b>658</b>	Glass Rack Dolly	20 1/2" x 20 1/2" x 5 1/4"	14 lbs.

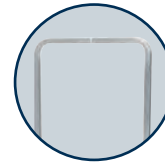

**Optional**  
Glass Rack Dolly Handle  
(Assembly Required)  
**RA-14 \$638**

## ALUMINUM DUNNAGE RACKS

### Stationary Dunnage Racks

8" & 12" Height Available



12" Height		8" Height		Size	# of Legs	Distribution Weight Capacity	Approx. Wt.
Model #	Price	Model #	Price				
DUN-2036	<b>\$400</b>	DUN-2036-8	<b>\$400</b>	20" x 36"	4	1500 lbs.	10 lbs.
DUN-2048	<b>463</b>	DUN-2048-8	<b>463</b>	20" x 48"	4	1800 lbs.	12 lbs.
DUN-2060	<b>526</b>	DUN-2060-8	<b>526</b>	20" x 60"	6	2000 lbs.	16 lbs.
DUN-2436	<b>452</b>	DUN-2436-8	<b>452</b>	24" x 36"	4	1500 lbs.	11 lbs.
DUN-2448	<b>526</b>	DUN-2448-8	<b>526</b>	24" x 48"	4	1800 lbs.	13 lbs.
DUN-2460	<b>587</b>	DUN-2460-8	<b>587</b>	24" x 60"	6	2000 lbs.	17 lbs.

### Mobile Dunnage Racks

- Four 6" Plate Casters (2 Swivel, 2 Stationary)
- Includes Pull Handle For Easier Mobility
- 2000 Lb. Rolling Capacity



**Now Includes Pull Handle**

### 36" Height with Handle

Model #	Price	Size	Distribution Weight Capacity	Approx. Wt.
DUN-2036C	<b>\$1069</b>	20" x 36"	1500 lbs.	35 lbs.
DUN-2048C	<b>1179</b>	20" x 48"	1800 lbs.	40 lbs.
DUN-2060C	<b>1373</b>	20" x 60"	2000 lbs.	45 lbs.

# SHELVING

## Chrome & Green Epoxy Wire Shelving

All Items on This Page Ships via UPS

WIRE SHELVES 

Each Shelf Holds Up To 800 Lbs. Distributed Weight

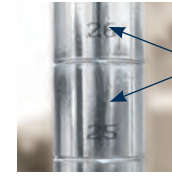
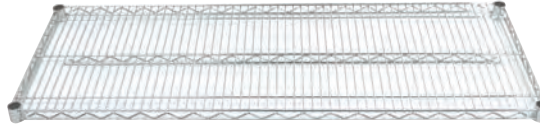

Posts are Numbered for easy assembly

	Shelf Size	CHROME	GREEN EPOXY	Price (Each)	Price (Set of 4)	Approx. Boxed Wt.	Approx. Boxed Cu. Ft.
<b>14" WIDE</b>	14" x 24"	EC-1424	EG-1424	\$90	\$360	35 lbs.	1.5
	14" x 30"	EC-1430	EG-1430	94	376	41 lbs.	2
	14" x 36"	EC-1436	EG-1436	100	400	47 lbs.	2.5
	14" x 42"	EC-1442	EG-1442	110	440	52 lbs.	3
	14" x 48"	EC-1448	EG-1448	121	484	58 lbs.	3.5
	14" x 60"	EC-1460	EG-1460	134	536	38 lbs.	2
	14" x 72"	EC-1472	EG-1472	180	720	45 lbs.	2.5
<b>18" WIDE</b>	18" x 24"	EC-1824	EG-1824	99	396	39 lbs.	2
	18" x 30"	EC-1830	EG-1830	101	404	45 lbs.	2.5
	18" x 36"	EC-1836	EG-1836	110	440	51 lbs.	3
	18" x 42"	EC-1842	EG-1842	130	520	56 lbs.	3.5
	18" x 48"	EC-1848	EG-1848	134	536	64 lbs.	4
	18" x 54"	EC-1854	EG-1854	171	684	35 lbs.	2
	18" x 60"	EC-1860	EG-1860	176	704	41 lbs.	2.5
<b>21" WIDE</b>	21" x 24"	EC-2124	EG-2124	105	420	42 lbs.	2.5
	21" x 30"	EC-2130	EG-2130	121	484	49 lbs.	3
	21" x 36"	EC-2136	EG-2136	131	524	56 lbs.	3.5
	21" x 42"	EC-2142	EG-2142	153	612	62 lbs.	4
	21" x 48"	EC-2148	EG-2148	164	656	70 lbs.	4.5
	21" x 54"	EC-2154	EG-2154	177	708	39 lbs.	2.5
	21" x 60"	EC-2160	EG-2160	198	792	45 lbs.	3
<b>24" WIDE</b>	24" x 24"	EC-2424	EG-2424	120	480	44 lbs.	3
	24" x 30"	EC-2430	EG-2430	134	536	51 lbs.	3.5
	24" x 36"	EC-2436	EG-2436	150	600	58 lbs.	4
	24" x 42"	EC-2442	EG-2442	164	656	64 lbs.	5
	24" x 48"	EC-2448	EG-2448	176	704	72 lbs.	5.5
	24" x 54"	EC-2454	EG-2454	206	824	41 lbs.	3
	24" x 60"	EC-2460	EG-2460	215	860	47 lbs.	3.5
	24" x 72"	EC-2472	EG-2472	245	980	55 lbs.	4

24" To 48" Length Shelves Are Packed 4 To A Box And 54", 60" And 72" Shelves Are Packed 2 To A Box.  
4 Pair Plastic Split Sleeves Are Included With Each Shelf.

## POSTS FOR WIRE SHELVING

Posts Are Numbered

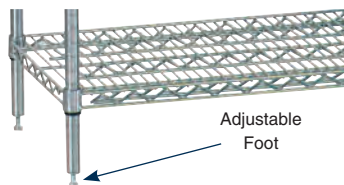

Post Height	Posts With Adjustable Foot				Posts For Casters (Casters Priced Separately)				Approx. Boxed Wt.	Approx. Cu. Ft.
	CHROME	GREEN EPOXY	Each	Set of 4	CHROME	GREEN EPOXY	Each	Set of 4		
14"	ECP-14	EGP-14	\$41	\$164	ECPC-14	EGPC-14	\$42	\$168	4 lbs.	.07
34"	ECP-34	EGP-34	54	216	ECPC-34	EGPC-34	54	216	8 lbs.	.18
54"	ECP-54	EGP-54	59	236	ECPC-54	EGPC-54	61	244	12 lbs.	.28
64"	ECP-64	EGP-64	64	256	ECPC-64	EGPC-64	69	276	15 lbs.	.33
74"	ECP-74	EGP-74	75	300	ECPC-74	EGPC-74	75	300	17 lbs.	.39
86"	ECP-86	EGP-86	90	360	ECPC-86	EGPC-86	90	360	20 lbs.	.45

### 5" CASTERS

Sets Feature 4 - 5" Swivel Casters (2 w/ Brakes & 4 Donut Bumpers)

Casters For Wire Shelving Only, See **Page 68** For Casters For Tables.

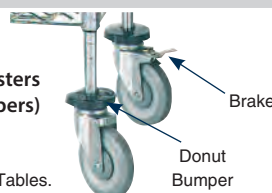

1000 lb. Max. Load Capacity For Shelving Casters

EC-25 Rubber Casters.....\$393 /set of 4

EC-26 Poly Casters..... 484 /set of 4

All Items on This Page Ships via UPS

# SHELVING

## Shelving Combos

### CHROME & GREEN EPOXY WIRE SHELVING COMBOS



Includes 4 Wire Shelves And 4 - 74" Posts



Chrome



Green Epoxy

Chrome		Green Epoxy		Shelf Size	Post Height	Approx. Wt.
Model #	Price	Model #	Price			
ECC-1436	700	EGG-1436	700	14" x 36"	74"	64 lbs.
ECC-1442	740	EGG-1442	740	14" x 42"	74"	69 lbs.
ECC-1448	784	EGG-1448	784	14" x 48"	74"	75 lbs.
ECC-1460	836	EGG-1460	836	14" x 60"	74"	93 lbs.
ECC-1472	1020	EGG-1472	1020	14" x 72"	74"	107 lbs.
ECC-1836	740	EGG-1836	740	18" x 36"	74"	68 lbs.
ECC-1842	820	EGG-1842	820	18" x 42"	74"	73 lbs.
ECC-1848	836	EGG-1848	836	18" x 48"	74"	81 lbs.
ECC-1854	981	EGG-1854	981	18" x 54"	74"	88 lbs.
ECC-1860	1004	EGG-1860	1004	18" x 60"	74"	99 lbs.
ECC-1872	1124	EGG-1872	1124	18" x 72"	74"	115 lbs.
ECC-2436	900	EGG-2436	900	24" x 36"	74"	75 lbs.
ECC-2442	955	EGG-2442	955	24" x 42"	74"	81 lbs.
ECC-2448	1004	EGG-2448	1004	24" x 48"	74"	89 lbs.
ECC-2454	1124	EGG-2454	1124	24" x 54"	74"	97 lbs.
ECC-2460	1160	EGG-2460	1160	24" x 60"	74"	111 lbs.
ECC-2472	1280	EGG-2472	1280	24" x 72"	74"	127 lbs.

### MOBILE CARTS

Includes 4 Chrome Wire Shelves  
And 4 - 64" Posts

- 4 Swivel Casters  
(2 with Brakes & 4 Donut Bumpers)
- Finished Height of 70"
- Weight Capacity Not To Exceed  
1000 lbs. Total Weight



w/ Rubber Casters		w/ Poly Casters		Shelf Size	Approx. Wt.
Model #	Price	Model #	Price		
MC-1836R	\$1109	MC-1836P	\$1200	18" x 36"	43 lbs.
MC-1848R	1205	MC-1848P	1296	18" x 48"	55 lbs.
MC-1860R	1373	MC-1860P	1464	18" x 60"	86 lbs.
MC-2436R	1269	MC-2436P	1360	24" x 36"	62 lbs.
MC-2448R	1373	MC-2448P	1464	24" x 48"	76 lbs.
MC-2460R	1529	MC-2460P	1620	24" x 60"	98 lbs.

FOR ADDITIONAL SHELVING, SEE PAGE 148

### WIRE UTILITY CARTS

- 3 Chrome Wire Shelves
- Tubular Numbered Handles
- 12 Plastic Split Sleeves
- 32" Finished Height
- 4 - Swivel Casters (2 w/ Brakes & Donut Bumpers)



Rubber Casters		Poly Casters		Size	Approx. Wt.	Approx. Cu. Ft.
Model #	Price	Model #	Price			
WUC-1836R	\$979	WUC-1836P	\$1070	18" x 36"	53 lbs.	3
WUC-1842R	1039	WUC-1842P	1130	18" x 42"	55 lbs.	4
WUC-2436R	1137	WUC-2436P	1228	24" x 36"	58 lbs.	4
WUC-2442R	1179	WUC-2442P	1270	24" x 42"	61 lbs.	5

800 lb. Capacity      1000 lb. Capacity

### UTILITY CART HANDLES

34" Tubular Numbered Posts  
(Fits EC-25 And EC-26 Casters)

Model #	Price	Width
UCH-18	\$128 ea.	18"
UCH-24	147 ea.	24"



### SOLID STAINLESS STEEL SHELVES

Use With Chrome Posts Only  
(Posts Not Included)

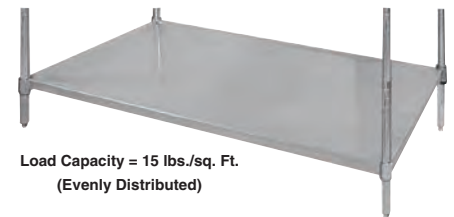

Load Capacity = 15 lbs./sq. Ft.  
(Evenly Distributed)

Model #	Price	Width
SH-1824	\$439 ea.	18" x 24"
SH-1836	551 ea.	18" x 36"
SH-1842	590 ea.	18" x 42"
SH-1848	657 ea.	18" x 48"
SH-1860	794 ea.	18" x 60"

# WIRE SHELVING

## Specialty Wire Shelving & Accessories

### WALL SHELF MOUNTING BRACKETS

Single Mount Includes 2 Brackets  
& 4 Collar Filler Caps

Double Mount Includes 1 Bracket

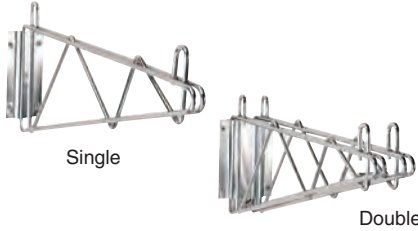

Chrome	Green Epoxy	Price	Size	Approx. Wt.
<b>SINGLE BRACKET</b>				
SB-14	GB-14	\$150	14"	2 lbs.
SB-18	GB-18	185	18"	3 lbs.
<b>DOUBLE BRACKET (For Adjoining Shelves)</b>				
DB-14	GDB-14	\$176	14"	3 lbs.
DB-18	GDB-18	229	18"	4 lbs.

### WALL MOUNTED SHELVING SYSTEM

Mounting Hardware Included • Shelves Sold Separately

- End Mount Kit**
- 4 Single Shelf Brackets
  - 2 - 34" Posts
  - Collar Filler Caps

AB2-14 **\$337**    AB2-18 **\$449**  
14" Wide            18" Wide

- Mid-Mount Kit**
- 2 Double Shelf Brackets
  - 1 - 34" Posts
  - For Adjoining Shelves

ABM2-14 **\$233**    ABM2-18 **\$275**  
14" Wide            18" Wide

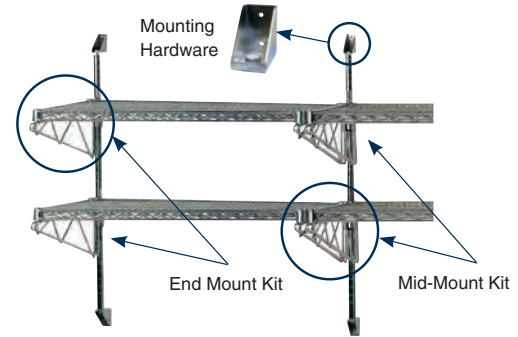

For Additional Tiers, Order Larger Posts On Page 150 With EC-50 Mounting Hardware For Each Post And Use The Following Brackets.

### WALL MOUNTED SHELVING SYSTEM EXPANSION KITS

- Includes Adjustable Bracket(s)

2 Single End Mount Brackets

AAB-14 **\$92**  
14" Wide

AAB-18 **\$105**  
18" Wide

1 Double Mid-Mount Bracket

AABM-14 **\$119**  
14" Wide

AABM-18 **\$135**  
18" Wide

Mounting Hardware

- Includes 2 End Mounts & 1 Mid-Mount Per Post

EC-50 **\$75**

## REPLACEMENT PARTS & ACCESSORIES



EC-10



EC-16



EC-20



EC-30



EC-15



EC-11



EC-5



EC-40

EC-5	Post Clamp	.....	<b>\$28 ea.</b>
EC-10	Replacement Leveling Foot	.....	<b>19 ea.</b>
EC-11	Foot Plate	.....	<b>26 ea.</b>
EC-15	Chrome Collar Filler Caps	.....	<b>23 /pack</b>
	(For Add-Shelving and Wall Mounted Shelves - 4 per pack)		
EC-16	Plastic Post Cap (4 pair per pack)	.....	<b>20/pack</b>
EC-20	Tapered Split Sleeves (4 per pack)	.....	<b>23/pack</b>
EC-30	S Hooks for add-shelving (2 pair per pack)	.....	<b>34/pack</b>
EC-40	Black Label Holder (3" x 1")	.....	<b>34 ea.</b>

### CASTERS FOR WIRE SHELVING

5" Swivel Stem Casters (2 w/ Brakes & 4 - Donut Bumpers)

Load Capacity Is 500 Lbs. Per Set.



Rubber

EC-25 **\$393**  
Set of 4



Poly

EC-26 **\$484**  
7Set of 4

THESE CASTERS ARE FOR WIRE SHELVING UNITS ONLY.

See Page 68 For S/S Worktable Casters.



## ADVANCE TABCO WARRANTY

### General Terms for all Advance Tabco items (including those listed below):

- Warranty applies in the 48 contiguous United States only
- ALL WARRANTY WORK MUST BE AUTHORIZED BY THE FACTORY BEFORE ANY WORK IS PERFORMED. Work performed without prior authorization shall be covered under this warranty only at the sole discretion of Advance Tabco
- At no time will expenses to be paid under warranty exceed the original cost of the item
- Routine maintenance and wear items are not covered by warranty.
- Repair parts are sent by ground transportation. Any expedited freight charges will be at the expense of the end user
- Warranty applies only under conditions of normal use and does not apply to defects which result from negligence, misuse, freight damage, improper installation or accidents.
- Warranty does not include any coverage for loss of business, damages, freight or other miscellaneous expenses incurred due to the defect or in servicing the unit.
- This warranty is made in lieu of all other warranties express or implied and no additional warranties express or implied, including one of merchantability or fitness for a particular purpose are given.
- If defects are the result of **freight or handling damage** your first recourse MUST be to notify the delivering freight carrier of the damage. If possible any damage should be noted on the delivery receipt at the time of delivery. Defects due to freight damage should be referred to the freight carrier for correction and compensation (this applies regardless of who was responsible for paying the freight charges or selecting the carrier).
- **Hot Food and Refrigerated Tables and Drop-Ins** are warranted for 12 months from the date of shipment from the factory or 6 months from the date first placed into service (whichever comes first) and include the following terms:
  - Applies only to parts directly related to the electric, gas or refrigeration components of covered items (see below for all other parts)
  - Covers parts and labor during the warranty period (refrigeration components include labor coverage for 12 months from date of shipment or 3 months from date placed into service, with parts covered as described above). Labor performed after hours, as overtime, on weekends or on holidays is not covered by this warranty (end user may authorize and pay such expenses directly to service agency if desired)
  - Includes travel up to 100 miles round trip or 2 hours of travel time (additional travel will be at the end users expense)
- **Refrigeration Compressors for Tables and Drop-ins are eligible for additional optional warranty coverage (if purchased):**
  - Must be purchased at the time the covered unit is ordered from the factory
  - Valid for 60 months from the date of shipment from the factory
  - Covers parts only (no labor, no freight). Applies only to the compressor unit
  - Excludes the cost of refrigerant
- **Refrigerated underbar equipment (Glass Frosters, Bottle Coolers, Back Bar Refrigeration)** is warranted for 24 months from the date of shipment from the factory and includes the following terms:
  - Covers parts and labor during the warranty period. Labor performed after hours, as overtime, on weekends or on holidays is not covered by this warranty (end user may authorize and pay such expenses directly to service agency if desired)
  - Includes travel up to 100 miles round trip or 2 hours of travel time (additional travel will be at the end users expense)
  - Compressors only are warranted for a total of 60 months parts only (36 months parts after the initial 24 month parts and labor coverage)
- **Ware Washing Machines** are warranted for 12 months from the date of shipment from the factory and include the following terms:
  - Covers parts and labor during the warranty period. Labor performed after hours, as overtime, on weekends or on holidays is not covered by this warranty
  - Includes travel up to 100 miles round trip or 2 hours of travel time (additional travel will be at the end users expense)
  - Any repairs or service conducted other than by an authorized service agent will void this warranty
- **All Advance Tabco items not mentioned above (including parts not otherwise covered for hot food and refrigerated units)** are warranted free of defects in workmanship and materials for 90 days from the date of shipment from the factory. Warranty includes parts only (no labor). At Advance Tabco's discretion we may repair or replace the defective item.

## TERMS & CONDITIONS

All previous prices and discounts are hereby withdrawn

- All prices are F.O.B. factory.
- All prices, specifications and discounts subject to change without notice. Prices listed herein do not include Federal Excise, Municipal or other use Tax.
- Orders that are shipped to an active construction site or residential address are subject to additional charges by the carrier. These charges may be applied after shipment.
- Not responsible for any damage while in hands of carrier. Inspect immediately for hidden damage. (For any damage and loss while in transit, promptly file claim against carrier.)
- Merchandise shipped open account to those firms furnishing satisfactory credit references. Terms are 1% Discount - 10 days; Net - 30 days.
- Quotations, unless otherwise stated, are for 60 day acceptance.
- Returns: A 30% handling charge will be applied to all authorized returns. **Minimum charge \$50.00. Equipment older than 90 days is not eligible for returns.**
- A 50% handling charge will be applied to all unauthorized returns.
- Orders for special items are not subject to cancellation without our written consent.
- Our consent must be obtained before defective merchandise is returned. Incoming freight or express charges may be collected and exchanged items will be shipped prepaid.
- On return shipments that we sanction, where orders have been correctly filled out and not defective, the incoming freight or express charges must be prepaid. Credit will then be issued, less a reasonable handling charge and less whatever expense is necessary to put goods in salable condition.
- We are not responsible for any delays in delivery which are beyond our control such as fires, strikes, delays in transportation or any contingencies of similar character.
- All orders subject to acceptance at our office.
- Possession of price list does not constitute an offer to sell.
- Minimum charge on all orders is \$50.00 NET.

## GENERAL SHIPPING INFORMATION

1. We reserve the right to ship via carriers that in our opinion are the most efficient. We will follow customers routing if possible.
2. Unless specified, all orders shipped freight collect.
3. All "Drop Shipments" will be shipped "Prepaid & Charge".
4. Shipper is not responsible for any unauthorized accessorial charges. All charges will be billed back to customer.

## PREPAID FREIGHT CHARGES

- Minimum UPS charge = \$20.00.
- Estimated freight charges added to an invoice will include a nominal administrative charge per freight bill.

## ESTIMATED SHIPPING WEIGHTS ARE TO SERVE AS A GUIDE ONLY!

- Weights are averaged for all models within a given classification. Actual shipping weights may vary from those shown. Correct weight will be shown on your Bill of Lading.

This Price Guide Supersedes May 2022 Price Guide.



**ADVANCE TABCO**  
SMART FABRICATION™

*Introducing...*

# Our Newest Facility!

Selmer, TN

NATIONWIDE  
STAINLESS STEEL FABRICATION

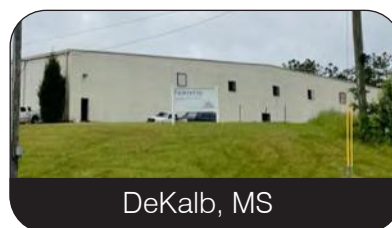
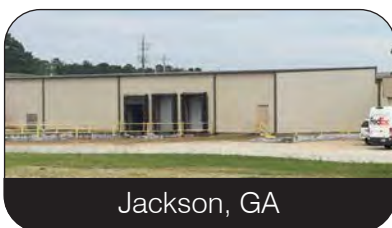
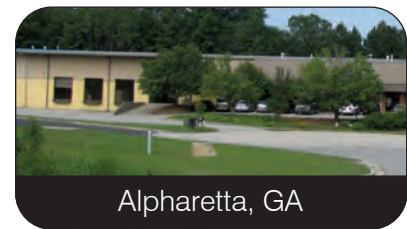
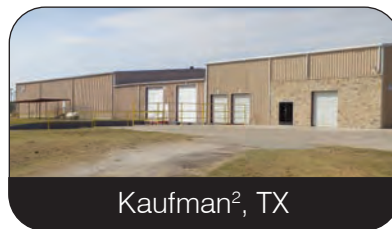
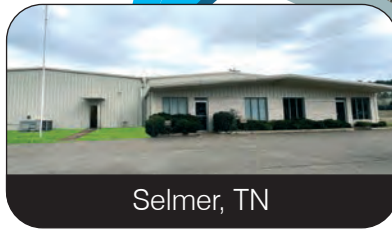

Customer Service Around The Country!

Corporate Headquarters: 325 Wireless Boulevard | Hauppauge | NY | 11788

National Manufacturing: Georgia² | Tennessee² | Texas² | Mississippi² | New York | Reno | South Carolina

